

MoviPol-5

Instruction Manual

Original Instructions



CE

Doc. no.: 15967025_A_en
Date of release: 2022.01.10

Copyright

The contents of this manual are the property of Struers ApS. Reproduction of any part of this manual without the written permission of Struers ApS is not allowed.

All rights reserved. © Struers ApS 2022.01.27.

Table of Contents

1	About this manual	6
2	Safety	6
2.1	Intended use	6
2.1.1	MoviPol-5 safety precautions	7
2.2	Safety messages	8
2.3	Safety messages in this manual	9
2.4	Symbols on the device	11
2.5	Working with electrolytes	11
2.5.1	Perchloric acid	12
3	Getting started	16
3.1	Device description	16
3.2	MoviPol-5 - overview	17
3.3	Accessories and consumables	18
4	Transport and storage	19
4.1	Transport	19
4.2	Air transport	19
4.3	Transport - the shoulder strap	20
4.4	Storage	20
5	Installation	21
5.1	Unpacking	21
5.2	Checking the packing list	21
5.3	Placing the machine	21
5.4	Power supply	22
5.4.1	Connecting the battery charger	22
5.4.2	Inserting the battery pack	23
5.4.3	Charging the battery	24
5.5	Connecting the anode	25
5.6	Fitting the polishing chamber	25
5.7	Connecting an external etching kit (option)	25
5.8	Noise	25
6	Operating the device	26
6.1	Control panel	26
6.2	Preparing the device for operation	27
6.3	Switching on the machine	27

6.4	Display	27
6.4.1	Main menu	28
6.4.2	Changing settings and text	29
6.5	Working with electrolytes	30
6.5.1	Filling the electrolyte cartridge	31
6.5.2	Inserting the electrolyte cartridge	32
6.5.3	The electrolyte usage counter	34
6.5.4	Replacing the electrolyte cartridge	34
6.6	Methods	35
6.6.1	Creating a method	37
6.7	Starting the polishing/etching process	37
6.8	Stopping the polishing/etching process	38
6.9	Emptying electrolyte from the holder	39
6.10	External etching (option)	39
7	Configuration	40
7.1	Electrolyte configuration	41
7.2	User options	43
7.3	Process options	44
8	Troubleshooting	44
8.1	Troubleshooting - Mechanical problems	44
8.2	Troubleshooting - Polishing problems	45
9	Maintenance and service - Movipol-5	46
9.1	Before each use	46
9.2	Battery pack	46
9.3	General cleaning	46
9.4	Daily	47
9.4.1	The pump system and polishing pistol holder	47
9.5	Weekly	47
9.6	The polishing chamber	48
9.7	Spare parts	48
9.8	Service information	48
9.9	Service and repair	48
9.10	Disposal	49
10	Technical data	49
10.1	Technical data - Movipol-5	49
10.2	Noise and vibration levels	50
10.3	Diagrams	51
10.3.1	Diagrams - Movipol-5	51
10.4	Legal and regulatory information	56

11 Manufacturer	56
Declaration of Conformity	57

1 About this manual

Instruction Manuals

Struers equipment must only be used in connection with and as described in the instruction manual supplied with the equipment.

 **Note**
Read the instruction manual carefully before use.

 **Note**
If you wish to view specific information in detail, see the online version of this manual.

2 Safety

2.1 Intended use

MoviPol-5 is a transportable polishing unit for on-site non-destructive electrolytic sample preparation and etching.

The equipment is designed for preparation of conductive materials, suitable for electrolytic polishing and etching. To operate correctly and safely, MoviPol-5 must be used with Struers purpose-designed consumables and accessories.

MoviPol-5 is only to be operated by adult/skilled/trained personnel in a professional working environment (e.g. a materialography laboratory). Maintenance and cleaning must be carried out on a regular schedule and according to instructions provided in this manual.

MoviPol-5 must always be operated in a well-ventilated area.

Do not use the machine for the following

Preparation of materials other than materials suitable for materialographic studies.

Preparation of any type of explosive and/or flammable material, or materials which are not stable during machining, heating or pressure.

Preparation using consumables or a combination of electrolytes and accessories which are not compatible for use with this equipment.

Model

MoviPol-5

2.1.1 Movipol-5 safety precautions



Read carefully before use

Specific safety precautions - residual risks

1. The operator must read the Instruction Manual and, where applicable, the Safety Data Sheets for the applied consumables.
2. The operator must be fully instructed in how to handle and use electrolytes with this machine.
3. The equipment must only be used in non-wet conditions.
4. Do not carry out preparation on unstable materials.
5. Make sure that the carrying handle and the shoulder strap are intact. Replace them if damaged. If you are using the shoulder strap to carry the machine, make sure that the buckle is safely fastened.
6. Make sure that your working space is well-ventilated. Polishing and etching can result in the production of fumes.
7. Always use goggles or a protective shield, and chemical-resistant gloves.
8. Danger of chemical burns. Follow all safety requirements for handling, mixing, emptying and disposing of electrolytes.

General safety precautions

1. Ignoring this information and mishandling of the equipment can lead to severe bodily injuries and material damage.
2. Struers equipment must only be used in connection with and as described in the instruction manual supplied with the equipment.
3. Accessories: Only use accessories specifically developed for use with this type of machine.
4. The device is designed to be used with Struers consumables specially designed for this purpose and this type of device.
5. Consumables: only use consumables specifically developed for use with this type of materialographic machine.
6. Make sure that the actual electrical power supply voltage corresponds to the voltage stated on the type plate of the machine.
7. Make sure that power is disconnected before opening the cabinet or carrying out any service or maintenance tasks.
8. Do not operate the machine if there are visible cracks or damage to the unit.
9. The machine must be emptied of any remaining electrolyte, and it must be firmly secured during transportation.
10. Never leave the machine unattended when it is filled with electrolyte.
11. Place the polishing pistol in its holder when not in use. Wipe any electrolyte residue off the machine.
12. Always observe the maximum polishing voltage allowed at the current work site.

13. If the equipment is subjected to misuse, incorrect installation, alteration, neglect, accident or incorrect repair, Struers will accept no responsibility for damage to the user or the equipment.
14. Dismantling of any part of the equipment, during service or repair, should always be performed by a qualified technician (electromechanical, electronic, mechanical, pneumatic, etc.).

2.2 Safety messages

Signs used in safety messages

Struers uses the following signs to indicate potential hazards.



ELECTRICAL HAZARD

This sign indicates an electrical hazard which, if not avoided, will result in death or serious injury.



DANGER

This sign indicates a hazard with a high level of risk which, if not avoided, will result in death or serious injury.



WARNING

This sign indicates a hazard with a medium level of risk which, if not avoided, could result in death or serious injury.



CAUTION

This sign indicates a hazard with a low level of risk which, if not avoided, could result in minor or moderate injury.



CRUSHING HAZARD

This sign indicates a crushing hazard which, if not avoided, could result in minor, moderate or serious injury.

General messages



Note

This sign indicates that there is a risk of damage to property, or a need to proceed with special care.



Hint

This sign indicates that additional information and hints are available.

2.3 Safety messages in this manual

**WARNING**

Danger of chemical burns.
Follow all safety requirements for handling, mixing, emptying and disposing of electrolytes.

**WARNING**

Always wear a full-face shield or splash goggles, rubber gloves and a laboratory coat or coveralls when you are working with perchloric acid.

**WARNING**

Make sure that you are mixing the solvent in a chemical-fume hood designed for perchloric acid use.

**WARNING**

Do not use combustible or carbonaceous containers, reaction vessels, spill pans, storage shelves or similar materials when you work with perchloric acid.

**WARNING**

Always remove the battery before transport.

**WARNING**

Always remove the battery before storage.

**WARNING**

During transportation the device must not contain electrolyte and must not be turned upside down. During use, the equipment must not be tilted.

**WARNING**

Do not fill the electrolyte above the maximum level.

**WARNING**

Do not operate the machine if there are visible cracks or damage to the unit.

**CAUTION**

Always request and read the Safety Data Sheet for each electrolyte before you start working with it.

**CAUTION**

Many electrolytes contain alcohol or other flammable solvents. Always follow all safety precautions when working with these types of electrolyte.



CAUTION

The operator must be fully instructed in how to handle and use electrolytes with this machine.



CAUTION

The machine is designed to be used with electrolytes recommended by Struers. Electrolytes that are not recommended by Struers can be dangerous to the operator or harm the machine.



CAUTION

Fire and explosion hazards

- 60% perchloric acid is a very corrosive and oxidizing product. Heating it can cause an explosion, and contact with combustible materials can cause fire.
- Fire fighting must be carried out from a protected location. Use extinguishing media as specified in the Safety Data Sheet.



CAUTION

Make sure that there is adequate ventilation when you are using the equipment with perchloric acid, particularly if the equipment is carried or hung by the shoulder strap.



CAUTION

All persons involved in mixing, using, storing, transporting and disposing of electrolytes must be trained in how to handle perchloric acid when carrying out these tasks.

- Do not inhale any vapor from the solution or its components.
- Avoid skin contact.



CAUTION

Do not produce anhydrous perchloric acid, either from its salts or from aqueous solutions, e.g. by heating with high boiling acids or dehydrating agents such as sulfuric acid or phosphorous pentoxide. In addition to spontaneous explosion, the anhydrous acid explodes instantaneously on contact with oxidizable organic materials.



CAUTION

Limit the use or storage of perchloric acid to quantities less than 500 g per fume hood.



CAUTION

Struers equipment must only be used in connection with and as described in the instruction manual supplied with the equipment.



CAUTION

Always connect the battery charger to the battery pack before you connect the battery charger to the electrical power supply.

**CAUTION**

Do not use the machine with non-compatible accessories, battery or consumables.

**CAUTION**

Funnel, gloves, ventilation as well as all other prescribed equipment must be used during filling/emptying of electrolytes.

**CAUTION**

Do not start the pump until you hold the polishing pistol securely against the surface.

**CAUTION**

Before you carry or transport the machine to another location, make sure that you empty the holder of any remaining electrolyte.

**CAUTION**

Make sure that the actual electrical power supply voltage corresponds to the voltage stated on the type plate of the battery pack. Incorrect voltage can damage the electrical circuit.

2.4 Symbols on the device

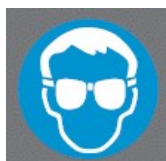

A Wear safety goggles

2.5 Working with electrolytes

When you are working with electrolytes, make sure that you observe all necessary safety precautions.

**WARNING**

Danger of chemical burns. Follow all safety requirements for handling, mixing, emptying and disposing of electrolytes.

**CAUTION**

Always request and read the Safety Data Sheet for each electrolyte before you start working with it.

**CAUTION**

Many electrolytes contain alcohol or other flammable solvents. Always follow all safety precautions when working with these types of electrolyte.



CAUTION

The operator must be fully instructed in how to handle and use electrolytes with this machine.



CAUTION

The machine is designed to be used with electrolytes recommended by Struers. Electrolytes that are not recommended by Struers can be dangerous to the operator or harm the machine.

Working with perchloric acid

See [Perchloric acid](#) ► 12.

Availability

Struers electrolytes are not marketed in the USA. If needed, the chemical compounds for the electrolyte must be purchased independently.

Contact your Struers representative for further information.

After use

Do not let the electrolyte dry or crystallize inside the machine or on the polished material.

Make sure that you rinse cleaning cloths used to wipe any drips or spills with water to prevent electrolyte from drying out.

Disposal

See [Disposal](#) ► 49.

2.5.1 Perchloric acid



CAUTION

Always request and read the Safety Data Sheet for each electrolyte before you start working with it.

If you are working with Struers electrolytes marked with the prefix A, you must mix a certain amount of perchloric acid into the electrolyte solution.

To find the Safety Data Sheet for the components in question, see: www.struers.com.



CAUTION

Fire and explosion hazards

- 60% perchloric acid is a very corrosive and oxidizing product. Heating it can cause an explosion, and contact with combustible materials can cause fire.
- Fire fighting must be carried out from a protected location. Use extinguishing media as specified in the Safety Data Sheet.

**CAUTION**

Make sure that there is adequate ventilation when you are using the equipment with perchloric acid, particularly if the equipment is carried or hung by the shoulder strap.

Training**CAUTION**

All persons involved in mixing, using, storing, transporting and disposing of electrolytes must be trained in how to handle perchloric acid when carrying out these tasks.

- Do not inhale any vapor from the solution or its components.
- Avoid skin contact.

Mixing perchloric acid into the electrolyte solution

If you are working with Struers electrolytes marked with the prefix A, you must mix a certain amount of perchloric acid into the electrolyte solution.

**WARNING**

Always wear a full-face shield or splash goggles, rubber gloves and a laboratory coat or coveralls when you are working with perchloric acid.

**WARNING**

Make sure that you are mixing the solvent in a chemical-fume hood designed for perchloric acid use.

**WARNING**

Do not use combustible or carbonaceous containers, reaction vessels, spill pans, storage shelves or similar materials when you work with perchloric acid.

**WARNING**

For information about electrolytes, see the Safety Data Sheet for the specific product.

Procedure**CAUTION**

The components must be used in the correct quantity as specified below.

Electrolyte A2		
<ol style="list-style-type: none"> Mix ethanol, butoxyethanol and water. Immediately before use, add A2 II - perchloric acid to the A2 I mixture. 		
Formula	A2 I	A2 II
	90 ml distilled water 730 ml ethanol 100 ml butoxyethanol	78 ml perchloric acid
Chemicals	All chemicals are chemically pure, preferably analytical grade. Per cent is, where no other is stated, weight per cent.	
	Butoxyethanol	Ethylene glycol monobutyl ether, CH ₃ -(CH ₂) ₂ -CH ₂ -O-CH ₂ -CH ₂ OH
	Ethanol 96% vol	CH ₃ -CH ₂ OH
	Perchloric acid	60%, HClO ₄
	Distilled water	H ₂ O
Health and Safety		
Before mixing, read the MSDS thoroughly for the specific components.		
The user must follow the instructions for proper work procedure according to the instruction manual supplied with the equipment.		
<div style="display: flex; align-items: center;">  <div> <p>Note The product must be disposed of according to local regulations for dangerous goods.</p> </div> </div>		

Electrolyte A3		
<ol style="list-style-type: none"> Mix ethanol and butoxyethanol. Immediately before use, add A3 II - perchloric acid to the A3 I mixture. 		
Formula	A3 I	A3 II
	600 ml methanol 360 ml butoxyethanol	60 ml perchloric acid
Chemicals	All chemicals are chemically pure, preferably analytical grade. Per cent is, where no other is stated, weight per cent.	
	Butoxyethanol	Ethylene glycol monobutyl ether, CH ₃ -(CH ₂) ₂ -CH ₂ -O-CH ₂ -CH ₂ OH
	Methanol	100% vol., CH ₃ OH
	Perchloric acid	60%, HClO ₄

Electrolyte A3**Health and Safety**

Before mixing, read the MSDS thoroughly for the specific components.

The user must follow the instructions for proper work procedure according to the instruction manual supplied with the equipment.

**Note**

The product must be disposed of according to local regulations for dangerous goods.

Electrolyte D2

1. Mix the phosphoric acid **in** the distilled water
2. Add ethanol, propanol and urea.

Formula	D2	
	500 ml distilled water	
	250 ml phosphoric acid	
	250 ml ethanol	
	50 ml propanol	
	5 g urea	
Chemicals	All chemicals are chemically pure, preferably analytical grade. Per cent is, where no other is stated, weight per cent.	
	Ethanol	96% vol., CH ₃ -CH ₂ OH
	Phosphoric acid	Ortho phosphoric acid 85%, (HO) ₃ PO
	Propanol	2-propanol 100%, CH ₃ -CH ₂ -CH ₂ OH
	Urea	CO(NH ₂) ₂
	Distilled water	H ₂ O

Health and Safety

Before mixing, read the MSDS thoroughly for the specific components.

The user must follow the instructions for proper work procedure according to the instruction manual supplied with the equipment.

**Note**

The product must be disposed of according to local regulations for dangerous goods.

Storing perchloric acid or solution

**CAUTION**

Do not produce anhydrous perchloric acid, either from its salts or from aqueous solutions, e.g. by heating with high boiling acids or dehydrating agents such as sulfuric acid or phosphorous pentoxide. In addition to spontaneous explosion, the anhydrous acid explodes instantaneously on contact with oxidizable organic materials.

**CAUTION**

Limit the use or storage of perchloric acid to quantities less than 500 g per fume hood.

3. Never let perchloric acid crystallize on bottle necks, caps or anywhere else.
4. Store the chemical in a secure, cool, and well-ventilated area with a metal, glass or ceramic spill catch pan.
5. Store the chemical away from other chemicals or combustible or organic materials.
6. Never let solutions dry out.

For more information, see the Safety Data Sheet for the product.

Disposal

See [Disposal ▶49](#).

3 Getting started

3.1 Device description

MoviPol-5 is used for on-site materialographic preparation and enables examination and quality inspection of metallographic materials.

Electrolytical polishing/etching can be performed on most metallic material surfaces. It is an electrochemical process, which can be performed on electrically conductive materials by applying an electrolyte and electricity to the test area.

Before starting the process, the user must wear protective goggles and gloves.

During the process, a high, local current, when applied to an area of the material covered by the electrolyte, will have a polishing/etching effect on the targeted surface. This makes the surface suitable for further materialographic analysis. The process is non-destructive and does not introduce deformation to the micro-structure of the workpiece.

MoviPol-5 is portable. It is packed in a case, which is suitable for transport by one person. The equipment has a replaceable, rechargeable battery. Electrolytes are contained in an electrolyte cartridge, which is filled/emptied by the operator.

The process starts with the operator identifying a relevant surface area and the type of material that needs inspection. A suitable method, accessory and electrolyte are identified. Before operation the operator places the equipment on a plane surface or, if carrying, keeps it level.

The area must be well ventilated to prevent inhalation in case of hazardous fumes.

Before the operator inserts the electrolyte cartridge, an electrolyte, which is suitable for the material that is to be prepared, must be selected. Once the electrolyte cartridge is inserted, the equipment must stay in the same location or be kept still and level if carried.

The operator starts the machine and guides the polishing pistol to the area of interest. During the electrolytical polishing/etching process, small layers of material can now be removed, and the uneven material surface can be reduced to a plane area for further analysis.

In case of excess heat and/or power consumption, the equipment switches off automatically.

After use, the electrolyte cartridge must be removed, and the equipment must be cleaned with water. Cleaning can be carried out using an electrolyte container filled with water. The equipment can then be placed in the carrying case, protected and ready for transport.

Maintenance and cleaning must be carried out as described in the instruction manual.

The machine is designed only to be used with suitable consumables and accessories (e.g. electrolytes).

3.2 Movipol-5 - overview

Movipol-5



- A Battery pack with connection for battery charger
- B Anode socket marked **Anode**
- C Shoulder strap
- D Display
- E Control panel
- F Polishing pistol
- G Conduit for storing the hose
- H Carrying handle

Polishing pistol

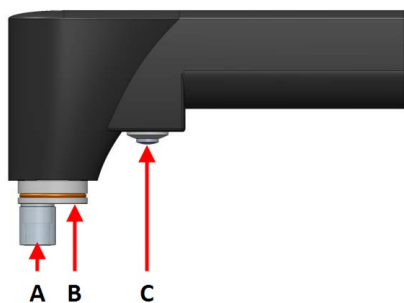

- A Polishing chamber. The cathode is in the base of the polishing chamber
- B Light
- C **Start/Stop** button

Electrolyte cartridge compartment

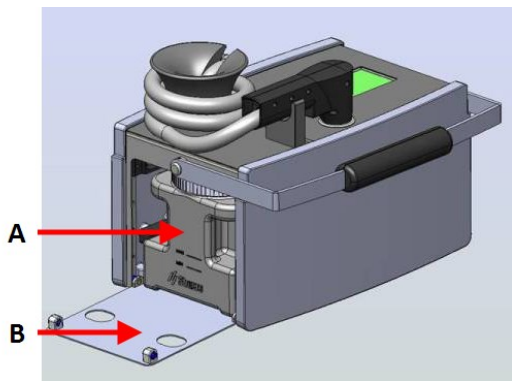

- A** Electrolyte cartridge
- B** Door

Control panel

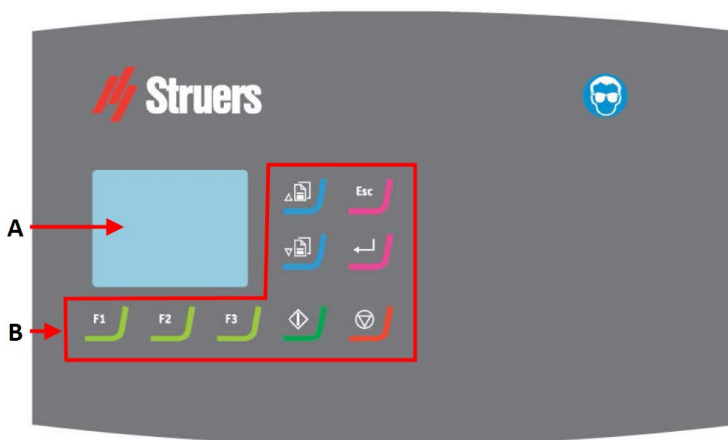

- A** Display
- B** Control buttons

See also [Control panel](#) ► 26.

3.3 Accessories and consumables

Consumables

The use of Struers consumables is recommended.

Other products may contain aggressive solvents, which dissolve e.g. rubber seals. The warranty may not cover damaged machine parts (e.g. seals and tubes), where the damage can be directly related to the use of consumables not supplied by Struers.

For information about the available range, see:

- [The Struers Consumables Catalogue](http://www.struers.com/Library) (<http://www.struers.com/Library>)

Accessories

For information about the available range, see:

- [Brochure for non-destructive preparation](http://www.struers.com/Library#brochures) (<http://www.struers.com/Library#brochures>)

4 Transport and storage

4.1 Transport

If, at any time after the installation, you have to move the unit or place it in storage, there is a number of guidelines we recommend that you follow.

- Package the unit securely before transportation.
Insufficient packaging could cause damage to the unit and will void the warranty. Contact Struers Service.
- Struers recommends that all original packaging and fittings are kept for future use.



WARNING

Always remove the battery before transport.

- Clean and dry the unit before transport and storage.
- Before transportation, make sure that the polishing pistol is placed in its holder and the hose is wound around the conduit.
- During transportation the unit must not contain electrolyte. See [Daily ▶ 47](#).

Air transport

See [Air transport ▶ 19](#)

Battery charger

See the Instruction Manual for this unit.

Battery Pack

Operating environment	0 to 45°C/32 to 113°F
Transport and storage	-20 to +55°C/°F

See the Instruction Manual for this unit.

For more detailed information, see the section **Technical data**.

4.2 Air transport



Note

Contact your transportation provider for information on local carriage restrictions. See the IATA website for further information.

- Clean and dry the unit before transport and storage.

Lithium batteries



WARNING

Always remove the battery before transport.



Note

Contact your transportation provider for information on local carriage restrictions.

There are restrictions on the carriage of lithium batteries.

The battery has a Watt-hour rating of 98.28 Wh. The battery is classed as a small battery.

4.3 Transport - the shoulder strap

Attaching the shoulder strap

If you wish to use the shoulder strap for hanging or carrying the unit:

1. Attach the shoulder strap to the unit.
2. Use the loops and buckle to secure the shoulder strap in place.



Note

Before each use, make sure that the carrying handle, the shoulder strap and the buckle are not damaged, and that the buckle is correctly fastened. Replace any damaged parts.

4.4 Storage



Note

Struers recommends that all original packaging and fittings are kept for future use.



WARNING

Always remove the battery before storage.

- Remove any accessories.
- Clean and dry the unit before storage.
- Place the machine and accessories in their original packaging.
- For more detailed information, see the section **Technical data**.

Battery Pack

See the Instruction Manual for this unit.

5 Installation



WARNING

Struers equipment must only be used in connection with and as described in the instruction manual supplied with the equipment.

5.1 Unpacking



Note

Struers recommends that all original packaging and fittings are kept for future use.

1. Cut the packing tape on the top of the box.
2. Remove the loose parts.
3. Remove the unit from the box.

5.2 Checking the packing list

Optional accessories may be included in the packing box.

The packing box contains the following items:

Pcs.	Description
1	MoviPol-5
1	Battery charger
1	Battery Pack
1	Electrolyte container
1	Anode wire
1	Magnet
1	Shoulder strap
50	Polishing chambers
1	Instruction Manual set

5.3 Placing the machine

- Place the device on a flat, stable surface, or hang the device by the shoulder strap in a suitable place.



Note

The device will not function if it is tipped on its side.

5.4 Power supply



Note

The battery charger is shipped with 2 types of electrical power cables. If the plug supplied on these cables is not approved in your country, the plug must be replaced with an approved plug.

The European Schuko plug

The 2-pin plug (European Schuko) is for use on single-phase electrical power connections.



The leads must be connected as follows:

Yellow/Green	Earth (ground)
Brown	Line (live)
Blue	Neutral

The North American NEMA 5-15P plug

The 2-pin plug (North American NEMA 5-15P) is for use on single-phase electrical power connections.



The leads must be connected as follows:

Green	Earth (ground)
Black	Line (live)

5.4.1 Connecting the battery charger



Hint

See the Instruction Manual for this unit.



Note

You cannot connect the machine directly to the electrical power supply.



CAUTION

Always connect the battery charger to the battery pack before you connect the battery charger to the electrical power supply.



CAUTION

Make sure that the actual electrical power supply voltage corresponds to the voltage stated on the type plate of the battery pack. Incorrect voltage can damage the electrical circuit.

When the battery pack is inserted in the machine, the equipment can be connected directly to the electrical power supply through the battery charger.

Connecting the battery charger

1. Make sure that the battery pack is inserted in the machine.
2. Unscrew the cover covering the socket. **(A)**
3. Insert the plug from the battery charger into the socket. **(B)**
4. Connect the battery charger to the electrical power supply.

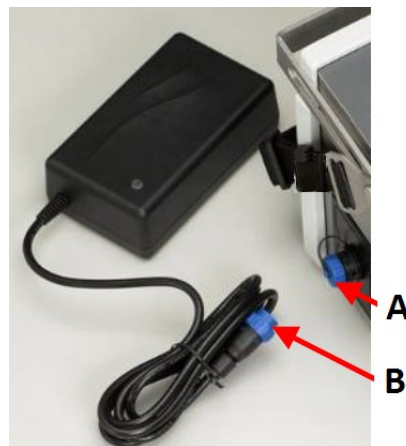

Connecting the battery charger to the electrical power supply

The electrical power supply cable is fitted on both ends with an IEC 320 cable.

1. Connect the cable to the charger.
2. Connect the battery charger to the electrical power supply.



5.4.2 Inserting the battery pack



CAUTION

Make sure that the actual electrical power supply voltage corresponds to the voltage stated on the type plate of the battery pack. Incorrect voltage can damage the electrical circuit.



Hint

See the Instruction Manual for this unit.



Note

Make sure that the battery pack is fully charged prior to use.



Note

The battery pack does not need to be inserted during charging.

When the battery pack is inserted in the machine, the equipment can be connected directly to the electrical power supply through the battery charger.

1. Slide the battery pack into the machine.
2. Click the battery pack into place.



5.4.3 Charging the battery

 **Hint**
See the Instruction Manual for this unit.

 **CAUTION**
Always connect the battery charger to the battery pack before you connect the battery charger to the electrical power supply.

 **Note**
The battery pack does not need to be inserted during charging.

 **Note**
Make sure that the battery pack is fully charged prior to use.

Procedure

1. Connect the battery charger to the battery pack.
2. Connect the battery charger to the electrical power supply.
The LED turns green when charging is complete.
3. Recharge the battery pack immediately after use.

Battery status

The battery status indicator is shown in the top right corner of the screen.
You can check the charge level of the battery pack:

1. When the main menu is shown, press the **Escape** button.



Color	Status
Green	The battery is fully charged. Charging has stopped.
Yellow	The battery is charged >80%. The battery charger is in timer mode. The current is less than maximum. Charging will continue for a preset period of time: 4 hours.
Orange	Maximum charge current (2A).

5.5 Connecting the anode

1. Place the connector of the anode wire in the socket marked **Anode**.
2. Use the magnet to attach the anode wire to the sample.
If needed, use a clamping kit (option) as an accessory for non-magnetic samples.
3. To remove the anode wire, press the button on the socket to release the plug.

5.6 Fitting the polishing chamber

1. Fit the polishing chamber onto the tip of the polishing pistol. The end with a groove fits against the polishing pistol.

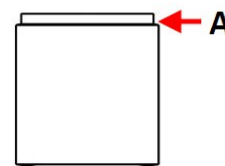

A Groove

5.7 Connecting an external etching kit (option)

You can connect an external etching kit (option) for etching with electrolytes without using the polishing pistol and the electrolyte cartridge.

1. Place the connector of the external etching anode wire in the socket marked **Anode**.

5.8 Noise

For information on the sound pressure level value, see this section: [Noise and vibration levels](#)

▶ 50

6 Operating the device



CAUTION
Do not use the machine with non-compatible accessories, battery or consumables.

6.1 Control panel



Control panel



Function key

- Press this button to activate controls for various purposes. See the bottom line of the individual screens.



Scroll up

- Press this button to scroll up in a screen and to increase the value of a setting.



Scroll down

- Press this button to scroll down in a screen and to decrease the value of a setting.



Escape

Use this button on the control panel to return to previous functions or values.

- Press the button to return to the main menu.
- Press the button to return to the last function or value.
- Press the button to cancel changes.



Select/Enter

- Press this button to enter a field, for instance a setting, to select a value, and to confirm a selection.



Start

- Starts the process.
- To switch on the machine, press this button for more than 3 seconds.



Stop

- Stops the process.
- To switch off the machine, press this button for more than 5 seconds.

6.2 Preparing the device for operation

- Place the machine on a stable and level surface, which can support the weight of the machine. You can also hang it using the shoulder strap.

6.3 Switching on the machine

- To switch on the machine, press the **Start** button for more than 3 seconds.



When you switch on the machine, the display shows the configuration and the version of the installed software.

Language

The first time you switch on the machine, you will be prompted to select the language you wish to use.

- Press the **Scroll up/Scroll up** buttons to select the language you wish to use.
- Press **Enter** to confirm your selection.



You can change the language, if needed. See [User options](#) ► 43.

Electrolytes

- The first time the machine is switched on, no electrolyte is registered.
You will be prompted to change the electrolyte.

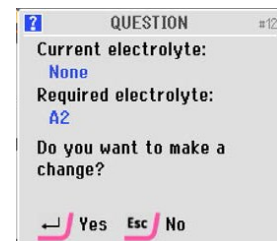

- Press **Enter** to confirm that you wish to change the electrolyte.



6.4 Display



Note

The screens shown in this manual may differ from the actual screens in the software.

The display is the user-interface to the software.

The display is divided into some main areas. See this example.

A Title bar

The title bar shows the function you have selected.

B Information fields

These fields show information about the selected function. In some fields you can select and change the value.

C Function key options

The functions shown depend on the screen that is displayed.



Language

You can change the language, if needed. See [User options ▶ 43](#).

Sound

Short beep

A short beep, when you press a key, indicates that the selection is confirmed.

You can enable or disable the beep. See [User options ▶ 43](#).

Long beep

A long beep, when you press a button, indicates that the key cannot be activated at the moment.

6.4.1 Main menu

From the **Main menu** screen you can choose between the following options:



• **Methods**

There are 5 predefined Struers methods in the database.

You can select one of the Struers methods, create a new method or change a Struers method to create a new method.

The Struers methods are locked. Changes must be saved under a different name.



• **Manual preparation**

The **Manual preparation** screen is useful when you develop methods.

You can adjust polishing and etching settings without selecting or creating a method.

If needed, save the method.



- **Maintenance**

From the **Maintenance** screen you can access cleaning, change of electrolyte, and service information.



- **Configuration**

From the **Configuration** screen you can access various configuration options.

Battery status

The battery status indicator is shown in the top right corner of the screen.



6.4.2 Changing settings and text

Changing settings

1. Select the screen where you wish to change a setting.
2. Scroll to the setting you wish to change.
3. Select the field where you wish to change the setting.
4. Access the value.
5. Scroll up or down, as needed, in the list of values.
6. Select the new value.
7. If needed, cancel the new setting.



Changing text values

1. Select the screen where you wish to change a text value.
2. Scroll to the setting you wish to change.



3. Select the setting where you wish to change the text value.
4. Access the setting.
A pop-up box is shown.
 - If there are only two values, press **Enter** to toggle between the two values.
 - Press **Escape** to select the new value.
5. In the pop-up box, scroll up or down, as needed.
6. Select the new value.
7. If needed, cancel the new setting.



Entering text

To enter a text, select the screen for entering the text, e.g. the **Methods** screen, where you can create a new method or rename an existing method.

1. Press **Save as** or **Rename** to enter a text of your choice.
The text editor is shown.
2. Enter the desired text.
3. Save the method.



6.5 Working with electrolytes

When you are working with electrolytes, make sure that you observe all necessary safety precautions.



WARNING

Danger of chemical burns.

Follow all safety requirements for handling, mixing, emptying and disposing of electrolytes.

**CAUTION**

Always request and read the Safety Data Sheet for each electrolyte before you start working with it.

**CAUTION**

Many electrolytes contain alcohol or other flammable solvents. Always follow all safety precautions when working with these types of electrolyte.

**CAUTION**

The operator must be fully instructed in how to handle and use electrolytes with this machine.

**CAUTION**

The machine is designed to be used with electrolytes recommended by Struers. Electrolytes that are not recommended by Struers can be dangerous to the operator or harm the machine.

Working with perchloric acid

See [Perchloric acid](#) ► 12.

Availability

Struers electrolytes are not marketed in the USA. If needed, the chemical compounds for the electrolyte must be purchased independently.

Contact your Struers representative for further information.

After use

Do not let the electrolyte dry or crystallize inside the machine or on the polished material.

Make sure that you rinse cleaning cloths used to wipe any drips or spills with water to prevent electrolyte from drying out.

Disposal

See [Disposal](#) ► 49.

6.5.1 Filling the electrolyte cartridge**WARNING**

Danger of chemical burns.
Follow all safety requirements for handling, mixing, emptying and disposing of electrolytes.

**WARNING**

Do not fill the electrolyte above the maximum level.



CAUTION

Always request and read the Safety Data Sheet for each electrolyte before you start working with it.



CAUTION

Many electrolytes contain alcohol or other flammable solvents. Always follow all safety precautions when working with these types of electrolyte.



CAUTION

The operator must be fully instructed in how to handle and use electrolytes with this machine.



CAUTION

The machine is designed to be used with electrolytes recommended by Struers. Electrolytes that are not recommended by Struers can be dangerous to the operator or harm the machine.



CAUTION

Funnel, gloves, ventilation as well as all other prescribed equipment must be used during filling/emptying of electrolytes.

Procedure

1. Open the lid of the electrolyte cartridge and carefully pour electrolyte into the electrolyte cartridge.
2. Make sure that the level of electrolyte is between the marks indicating the minimum and maximum levels.
 - Minimum level: 290 ml
 - Maximum level: 550 ml
3. Close the lid and screw it on securely.

6.5.2 Inserting the electrolyte cartridge



CAUTION

Do not use the machine with non-compatible accessories, battery or consumables.



WARNING

Danger of chemical burns.
Follow all safety requirements for handling, mixing, emptying and disposing of electrolytes.



CAUTION

Always request and read the Safety Data Sheet for each electrolyte before you start working with it.

**CAUTION**

The operator must be fully instructed in how to handle and use electrolytes with this machine.

**CAUTION**

The machine is designed to be used with electrolytes recommended by Struers. Electrolytes that are not recommended by Struers can be dangerous to the operator or harm the machine.

Procedure

1. Open the door of the electrolyte compartment.
 - If there is no electrolyte cartridge in the compartment, push the electrolyte tubes to the right side of the compartment.
 - If there is an electrolyte cartridge in the compartment, press the connectors to disconnect them from the electrolyte cartridge, and remove the electrolyte cartridge from the compartment.

Wipe the electrolyte cartridge and connectors with a damp cloth when you have removed the used electrolyte cartridge.

2. Slide the new electrolyte cartridge into the compartment.
3. Press the tube over the color coded fitting on the electrolyte cartridge. When you hear a click, this indicates that the fitting is secure.

The tube will not click onto the fitting unless the connector is fully open. To open the connector:

- Press the metal tab in fully, until you hear a click.

The connections are color coded:

- Red
Vent connection and spill return from the pistol holder.
- Orange
For electrolyte solution returning from the polishing chamber.
- Black
Suction to the polishing chamber.

4. Close the door of the electrolyte compartment.

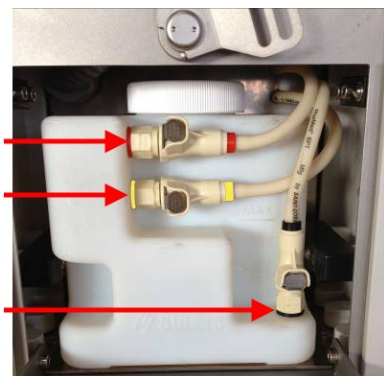

- A** Red
- B** Orange
- C** Black

6.5.3 The electrolyte usage counter

The electrolyte counter registers the number of times a particular electrolyte has been used. This makes it easier to know when the electrolyte cartridge must be refilled.

You can check which electrolyte is currently registered and check the usage counter.

1. In the **Main menu** screen, press **Escape**.
2. A pop-up window will display information about the electrolyte being used.



6.5.4 Replacing the electrolyte cartridge



CAUTION

Always request and read the Safety Data Sheet for each electrolyte before you start working with it.



CAUTION

The operator must be fully instructed in how to handle and use electrolytes with this machine.



CAUTION

The machine is designed to be used with electrolytes recommended by Struers. Electrolytes that are not recommended by Struers can be dangerous to the operator or harm the machine.

If you are prompted to change the electrolyte

If a method requires an electrolyte other than the one currently being used, you will be prompted to replace the electrolyte cartridge.

You will also be prompted to carry out a cleaning step for flushing out the electrolyte with water.

1. If you wish to change to a new type of electrolyte, press **Enter**.
2. Replace the electrolyte cartridge containing the current electrolyte with a cartridge containing the new electrolyte. See [Inserting the electrolyte cartridge](#) ► 32.
3. If you wish to continue using the current electrolyte, press **Esc**.



Changing the electrolyte from the Maintenance screen

From the **Maintenance** screen, you can change the electrolyte and select a step for flushing out the electrolyte with water.

1. If you wish to insert a cartridge with the same electrolyte or a new type of electrolyte, press **F1**.
2. Replace the electrolyte cartridge containing the current electrolyte with a new electrolyte cartridge. See [Inserting the electrolyte cartridge ▶ 32](#).
3. If you wish to insert an electrolyte cartridge with a new type of electrolyte, press **F2**.
4. Follow the on screen instructions.
5. When you have removed the used electrolyte cartridge, wipe the electrolyte cartridge and connectors with a damp cloth.



6.6 Methods

You can work with the following types of methods:

- **Struers methods**
These methods are predefined. You cannot change the settings. If needed, copy a method, change the settings, and save the method under a new name.
- **User-defined methods**
These methods you can copy and change as needed.

Selecting a method

1. From the **Main menu** screen, select **Methods**
2. Select the method you wish to use.
3. Select the method you wish to use.



The method database

The software provides you with a method database for frequently used materials: low carbon steel, stainless steel, copper, aluminum, and titanium. The method database ensures uniform results and repeatability.

You can store up to 20 methods in the database.



Hint

The operating range of the machine is from -10°C to 40°C (14 to 104°F). These methods apply to room temperature.

- Shorter preparation times are required for higher temperatures.
- Longer preparation times are required for lower temperatures.

Struers methods

Aluminum	
Electrolyte	A2
Voltage	48.0 V
Time	40 s
Flow	9

Carbon steel			
This method is also suitable for low alloy steels.			
Polishing		Etching	
Electrolyte	A2	Electrolyte	A2
Voltage	45.0 V	Voltage	2.5 V
Time	15 s	Time	5 s
Flow	8	Flow	6

Copper			
Polishing		Etching	
Electrolyte	D2	Electrolyte	D2
Voltage	24.0 V	Voltage	2.0 V
Time	20 s	Time	4 s
Flow	13	Flow	10

Stainless steel			
This method is also suitable for high alloy steels (duplex stainless steels) and austenitic nickel-chromium based superalloys (Inconel).			
Polishing		External etching	
Electrolyte	A2	Electrolyte	10% oxalic acid
Voltage	50.0 V	Voltage	15.0 V
Time	20 s	Time	30 s
Flow	13	Flow	-

Titanium	
Electrolyte	A3
Voltage	50.0 V
Time	20 s
Flow	8

6.6.1 Creating a method

To create a method, use a Struers method, a customized method, or create a method based on the **New method** template.



Hint

Struers methods are denoted by a locked lock symbol.



1. From the **Main menu** screen, select **Methods**
2. Select the method you wish to use.
3. Press **Rename** to enter a text of your choice.
The text editor is shown.
4. Enter the desired text.
5. Change the settings of the new method, as needed.
6. To save the method, press **Escape**.
7. Alternatively, press **Save as** to enter a text of your choice.



6.7 Starting the polishing/etching process

1. Make sure that the electrolyte cartridge has been filled with the correct type and amount of electrolyte.
2. Use the magnet supplied to connect the anode to the sample. If needed, use a clamping kit (option) as an accessory for non magnetic samples.
3. Select the method you wish to use.
4. If needed, adjust the method settings.
5. Take the polishing pistol from the holder and place it on the spot you wish to prepare.
6. Press the polishing pistol firmly against the prepared (pre-ground) surface and make sure that the polishing chamber is in full contact with the surface.
7. Keep the polishing pistol perpendicular (at an angle of 90°) to the surface.



CAUTION

Do not start the pump until you hold the polishing pistol securely against the surface.

**Note**

Make sure that no air is drawn in around the periphery of the polishing chamber.

8. Press the button on the polishing pistol or press the **Start** button.



- A pop-up window is shown to indicate the start of the process.
- The pump starts with maximum flow (large bubbles appear at the polishing surface).
- The LED on the polishing pistol lights up.
- Periodical beeps will sound until you once more press the button of the polishing pistol (or the **Start** button).

9. When no more bubbles appear and the sound of the motor changes, press the button on the polishing pistol or the **Start** button to start polishing/etching.

**Note**

Do not press the **Start** button until the noise from the pump indicates that the flow through the pistol is constant.

- The process voltage is activated and fine bubbles will appear at the surface.
- The pump reduces its flow to the value set in the method.
- The LED flashes (and remains lit) to signal that voltage is applied.
- Beeping stops.

6.8 Stopping the polishing/etching process

- During operation, you can stop the polishing/etching process at any time by pressing the button on the polishing pistol or by pressing **Stop**.



1. When the preset time has elapsed, polishing and etching stops automatically.
 - 3 beeps signal that the process is finished.
 - The LED flashes 3 times to signal that the process is finished (the LED remains lit).
 - A pop-up window is shown to indicate that the process is stopping.
2. Tilt the polishing chamber very slightly so that it produces a suction sound while the pump runs with maximum flow to draw as much as possible of the remaining electrolyte from the prepared surface.
 - The pump stops automatically after a predefined time or will stop immediately if you press the button on the polishing pistol. For a description of **Post-process clean-up time**, see [Process options ▶ 44](#).
 - The LED switches off.
3. Place the polishing pistol in the holder.

- Clean the polished spot with water/alcohol and dry it carefully.

**Note**

If you are working in a field location, it may be necessary to bring additional lighting to ensure safe handling of any electrolyte drips or spills.

- Wipe up any drips of electrolyte from the polishing pistol and the holder.

6.9 Emptying electrolyte from the holder

Before you carry or transport the machine to another location, you must empty any remaining electrolyte from the holder.

**CAUTION**

Always request and read the Safety Data Sheet for each electrolyte before you start working with it.

**CAUTION**

The operator must be fully instructed in how to handle and use electrolytes with this machine.

**CAUTION**

The machine is designed to be used with electrolytes recommended by Struers. Electrolytes that are not recommended by Struers can be dangerous to the operator or harm the machine.

**CAUTION**

Before you carry or transport the machine to another location, make sure that you empty the holder of any remaining electrolyte.

- Make sure the pistol is placed in the holder.
- Press **Start**, and then press **Stop**.
The pump runs for the preset post-process clean-up time to empty electrolyte from the holder. For a description of **Post-process clean-up time**, see [Process options ▶ 44](#).
- Use a soft, slightly damp cloth to wipe up any drops of electrolyte from the pistol and the holder.
- After use, clean the machine and any used electrolyte container system with water. See [Daily ▶ 47](#).



6.10 External etching (option)

After polishing with one electrolyte or after mechanical polishing, you can etch the sample by using a different electrolyte and the external etching connection. Use an external etching kit (option).

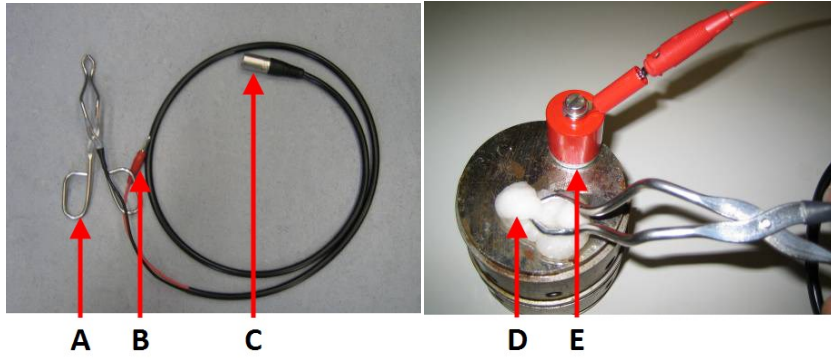

- A** Etching tongs
- B** Connection - to magnet
- C** Connection - to anode socket
- D** Cotton wool ball
- E** Magnet

Procedure

1. Use the magnet supplied with the machine to connect the anode to the sample. Use a clamping kit for non-magnetic samples (option).
2. Place the connector of the external etching kit in the socket marked **Anode**.
3. Adjust the settings for external etching, voltage and time.
4. Use the pair of tongs to grasp a ball of cotton wool.
5. Dip the ball of cotton wool in a suitable electrolyte (e.g. 10% oxalic acid for stainless steel).
6. Hold the tongs with the ball of cotton wool against the surface you wish to etch.
7. Do not start unless the tongs are held against the surface.
8. Press **Start** to begin the polishing/etching process.
9. To swab the specimen surface with the cotton wool, gently move the cotton wool back and forth to reduce build-up of heat.
10. When the preset time has elapsed, etching stops automatically.
11. Clean the polished spot with water/alcohol and dry it carefully.



7 Configuration

You can adjust a number of settings and parameters.

1. From the **Main menu** select **Configuration**.
2. From the **Configuration** menu, select:
 - **Electrolyte configuration**. See [Electrolyte configuration](#) ▶ 41.



- **User options.** See [User options ▶43](#)

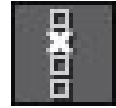

- **Process options.** See [Process options ▶44](#)

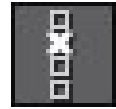

7.1 Electrolyte configuration

Predefined electrolytes

4 Struers electrolytes are configured in the database (A2, A3, D2 and 10% oxalic).

Several materials can be polished/etched with more than one of the electrolytes. The right choice depends on the composition of the material, the requirements to the final result, and the equipment used.

* Less suitable, but possible.

Electrolyte	Material
Electrolyte A2	Aluminum Antimony Beryllium Nickel Silver Stainless steel Steel Tin Titanium
Electrolyte A3	Martensitic steel Manganese Molybdenum Stainless steel, large areas Titanium Vanadium Zirconium
Electrolyte A5	Lead Tin Uranium

Electrolyte	Material
Electrolyte A6	Aluminum Cobalt Steel Tin
Electrolyte A8	Austenitic steel Chromium Hafnium Nickel Stainless steel Thorium Titanium
Electrolyte AC2	Beryllium Cast iron Low alloyed carbon steel Magnesium Nickel Stainless steel
Electrolyte B1	Antimony Cobalt Germanium Magnesium
Electrolyte C1	Cadmium Magnesium Lead Zinc
Electrolyte D1	Brass Copper Gold
Electrolyte E2	Brasses Bronzes Cerium Gold Indium

Electrolyte	Material
Electrolyte E5	Brass Bronze Carbon steel Cast iron * Materials with strongly varying structural elements *
Electrolyte F1	Sintered carbide * Tungsten

Creating user-defined electrolytes

You can create up to 10 user-defined electrolytes.

1. From the **Main menu** select **Configuration**.
2. From the **Configuration** menu, select **Electrolyte configuration**.
3. Scroll up or down to select **New electrolyte**.
4. Press **F3 Rename** to open the text editor and rename the electrolyte.



7.2 User options

You can adjust a number of settings.

1. From the **Main menu** select **Configuration**.
2. From the **Configuration** menu, select **User options**.



Options	Settings
Display brightness	1 - 100
Power-save time-out	0:05 – 15:00

Options	Settings
Language	Scroll to select the language you wish to use.
Keyboard sound	On/Off
Time	Format: hh:mm:ss
Date	Format: year-month-day
Shut down time-out	0:05 – 30:00

7.3 Process options

You can adjust a number of settings.

1. From the **Main menu** select **Configuration**.
2. From the **Configuration** menu, select **Process options**.

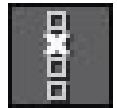

Options	Settings
Process time	Remaining/Increasing
Pol./etch. pause	0 – 10 s
Cleaning time	10 – 45 s
Pistol button sensitivity	High, Medium, Low
Post-process clean-up time	3 – 20 s

8 Troubleshooting

8.1 Troubleshooting - Mechanical problems



Note

Do not let the pump continue to run without a flow of electrolyte. Damage to the motor or tubing may occur.

Error	Cause	Action
The pump is running but there is no flow of electrolyte in the polishing pistol. Electrolyte accumulates in the polishing pistol holder.	The electrolyte inlet (to the polishing chamber) is blocked.	Make sure that the electrolyte tubes are correctly connected to the color coded fittings. If this does not help, remove the electrolyte cartridge and wipe the fittings with a soft, slightly damp cloth.
The pump is running but there is no flow of electrolyte. Excess pressure may result in the tubes being forced off.	The electrolyte outlet to the electrolyte cartridge is blocked.	
There is an increase of pressure in the electrolyte cartridge, and a flow of electrolyte from the polishing pistol.	The ventilation valve is blocked.	
There is an increase of pressure in the electrolyte cartridge. Excess pressure may result in the lid being forced off.	The ventilation valve and the inlet are blocked.	

8.2 Troubleshooting - Polishing problems

Electrolytes

- Check the age of the mixed electrolyte. The mixture should not be more than 3 months old. The A-2 electrolyte has a particularly short lifetime (approximately 2 months) when it is mixed.
- Check the number of polishings made with the electrolyte. The electrolyte can be worn out by too many polishings.
- Make sure that the correct combination of material and electrolyte is used.

Electrolyte cartridge

- Make sure that the electrolyte cartridge is connected correctly.

Power supply

- Make sure that the batteries are charged.

9 Maintenance and service - MoviPol-5

Proper maintenance is required to achieve the maximum up-time and operating lifetime of the machine. Maintenance is important in ensuring continued safe operation of your machine.

The maintenance procedures described in this section must be carried out by skilled or trained personnel.

Technical questions and spare parts

If you have technical questions or when you order spare parts, state serial number and voltage/frequency. The serial number and the voltage are stated on the type plate of the machine.

9.1 Before each use

- Check the machine before each use.
- If you hang or carry the machine by the shoulder strap, make sure that the strap is intact and that the buckle is correctly fastened.

9.2 Battery pack



CAUTION

Make sure that the actual electrical power supply voltage corresponds to the voltage stated on the type plate of the battery pack. Incorrect voltage can damage the electrical circuit.

Rechargeable batteries have a limited lifetime which largely depends on use and charging schedule.

To obtain the longest lifetime for the battery pack we recommend these maintenance procedures:

- If the battery pack has not been used for 3 months, recharge it.
- Do not allow the battery pack to become fully discharged.

9.3 General cleaning

To ensure a longer lifetime for your machine, Struers strongly recommends regular cleaning.



Note

Do not use a dry cloth on the display as the surface is not scratch resistant.



Note

Do not use acetone, benzol or similar solvents.

If the machine is not to be used for a longer period of time

- Clean the machine and all accessories thoroughly.

9.4 Daily



WARNING

Do not operate the machine if there are visible cracks or damage to the unit.

1. Clean the machine with a soft, slightly damp cloth and a mild detergent.
2. Make sure that electrolyte spills on the front plate or other parts of the cabinet are wiped off.
3. Keep the work surface under and around the machine clean.
Make sure that electrolyte spills are wiped off.

9.4.1 The pump system and polishing pistol holder

Clean the pump system and polishing pistol holder with water at least daily.

1. Clean the polishing pistol holder.
 - Place the polishing pistol in the holder and press **Start**.
 - Press **Stop**.
The pump runs for the time that has been set in **Post-process clean-up time** to empty electrolyte from the holder.



2. Use a soft, slightly damp cloth to wipe up any drips of electrolyte from the pistol and the holder.
3. Fill an electrolyte cartridge with water.
4. From the **Main menu** screen, select **Maintenance**.
5. Select **Cleaning**.
6. Follow the on screen instructions.
 1. Insert a cartridge with water and close the door.
 2. Press the polishing pistol against the sample and start the pump by the pistol or start button.
 3. Open the door to the electrolyte compartment.
 4. Remove the present electrolyte.
 5. Please wait for 9 sec.
 6. Open the door and remove the cartridge with water.
 7. Clean and dry the anode before storage.

9.5 Weekly



WARNING

Do not operate the machine if there are visible cracks or damage to the unit.

- Remove stains of metal oxide with cleansers and sealants of the type used for cars and fiberglass boats.

9.6 The polishing chamber



WARNING

Do not operate the machine if there are visible cracks or damage to the unit.

- Replace the PVC polishing chamber when it is worn or discolored.
- Wash off any electrolyte residue on the chamber before disposal.

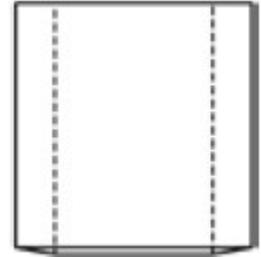

9.7 Spare parts

Technical questions and spare parts

If you have technical questions or when you order spare parts, state serial number and voltage/frequency. The serial number and the voltage are stated on the type plate of the machine.

For further information, or to check the availability of spare parts, contact Struers Service. Contact information is available on [Struers.com](https://www.struers.com).

9.8 Service information

You can view information about the conditions of the different components.

Service information can also be used in cooperation with a Struers service technician for remote diagnostics of the equipment.

Service information is read-only information. You cannot change any machine settings.

1. From the **Maintenance** menu, select **Service functions**.

The information is only available in English).

9.9 Service and repair

Struers recommends that a regular service check be carried out yearly or after every 1500 hours of use.

When the machine is started up, the display shows information about total operation time and the machines service information.

After 1500 hours of operation time, the display will show a message reminding the user that a service check should be scheduled.

**Note**

Service must only be performed by a Struers engineer or a qualified technician (electromechanical, electronic, mechanical, pneumatic, etc.).
Contact Struers Service.

Service check

Struers offers a range of comprehensive maintenance plans to suit the requirements of our customers. This range of services is called ServiceGuard.

The maintenance plans include equipment inspection, replacement of wear parts, adjustments/calibration for optimal operation, and a final functional test.

9.10 Disposal

Equipment marked with a WEEE symbol contains electrical and electronic components and must not be disposed of as general waste.

Contact your local authorities for information on the correct method of disposal in accordance with national legislation.



For disposal of consumables and recirculation fluid, follow local regulations.

Electrolytes

Contact your local authorities for information on the correct method of disposal in accordance with national legislation.

Polishing chambers

Wash off any electrolyte residue on the chamber before disposal.

10 Technical data

10.1 Technical data - MovPol-5

Subject		Specifications
Safety standards	See the Declaration of Conformity	
Polishing	Polishing power	Max. 180 W (60 V/ 3 A)
	Polishing area	Diameter: Approx. 9 mm (0.35")

Subject		Specifications
Power supply	Voltage - to battery charger	100-240 V AC, 50/60 Hz, max. 1.2 A
	Voltage - from battery charger	Max 25.5 V DC/2 A
	Power consumption	Constant: 5 W Intermittent: 180 W Maximum: 180 W
	Internal circuit fuse	15 AT, 6.3 x 32 mm (0.25" x 1.26")
	Embedded thermal overload protection	70°C
Operating environment	Surrounding temperature	5 - 40°C/41 - 104°F
	Humidity	< 95 % RH non-condensing
Storage and transport conditions	Surrounding temperature	0 - 60°C/32 - 140°F
	Humidity	< 90 % RH non-condensing
Dimensions and weight	Width	34 cm (13.4")
	Depth	21 cm (8.4")
	Height	26 cm (10.1")
	Length - flexible cable	1 m (40.6")
	Weight - Polishing pistol	150 g (0.33 lbs)
	Weight - including battery pack and empty electrolyte cartridge	8.5 kg (18.7 lbs)
	Weight - empty electrolyte cartridge	0.98 kg (2lbs)
	Max. volume - electrolyte cartridge	550 ml (21.9 oz)

10.2 Noise and vibration levels

Noise level	A-weighted sound emission pressure level at workstations	$L_{pA} = 59 \text{ dB(A)}$ (measured value) Uncertainty $K = 4 \text{ dB}$ Measurements made in accordance with EN ISO 11202
--------------------	--	---

10.3 Diagrams

If you wish to view specific information in detail, see the online version of this manual.

10.3.1 Diagrams - MoviPol-5

Title	No.
MoviPol-5, Block diagram	15963050 B
MoviPol-5, Circuit diagram	15963100 E
MoviPol-5, External etching kit, Circuit diagram	15963102 B

15963050 B

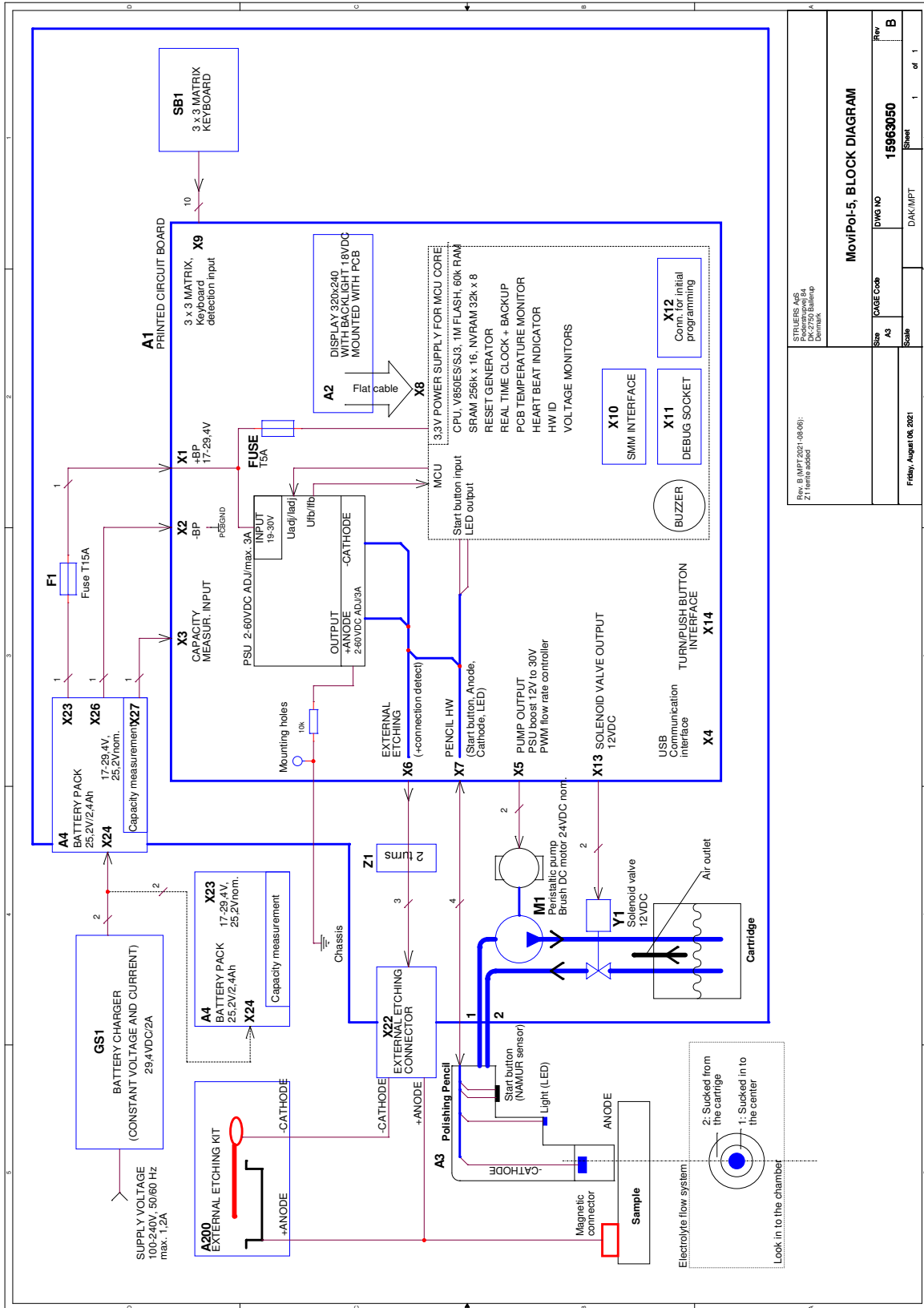

STJULERS A/S Røgersvej 84 Zetland, 8240 Skovlunde Denmark		MoviPol-5, BLOCK DIAGRAM	
Size	DAK/MIPT	DWG NO	15963050
Scale	1	Rev	B
Friday, August 06, 2021	1	Sheet	of 1

15963100 E

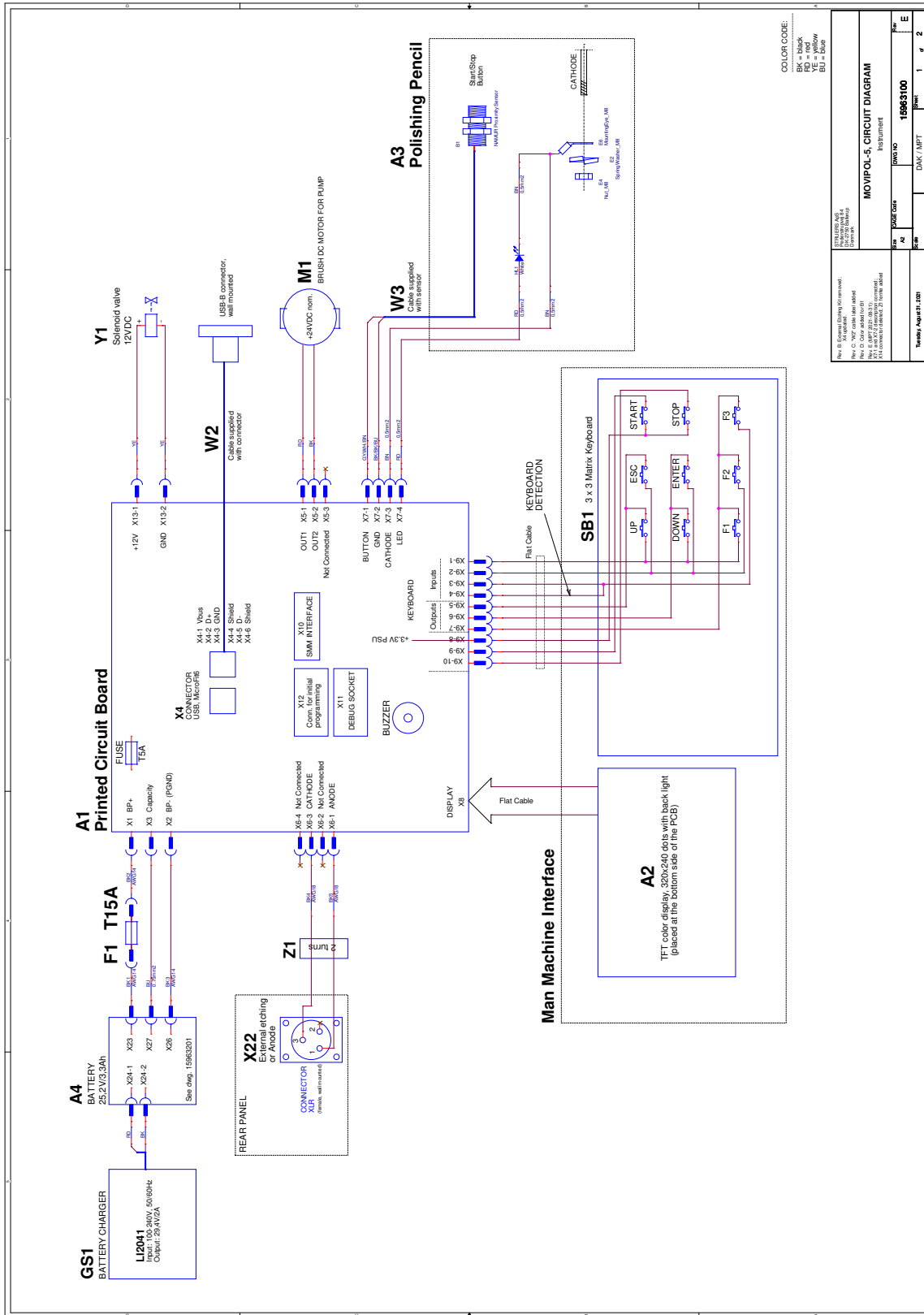

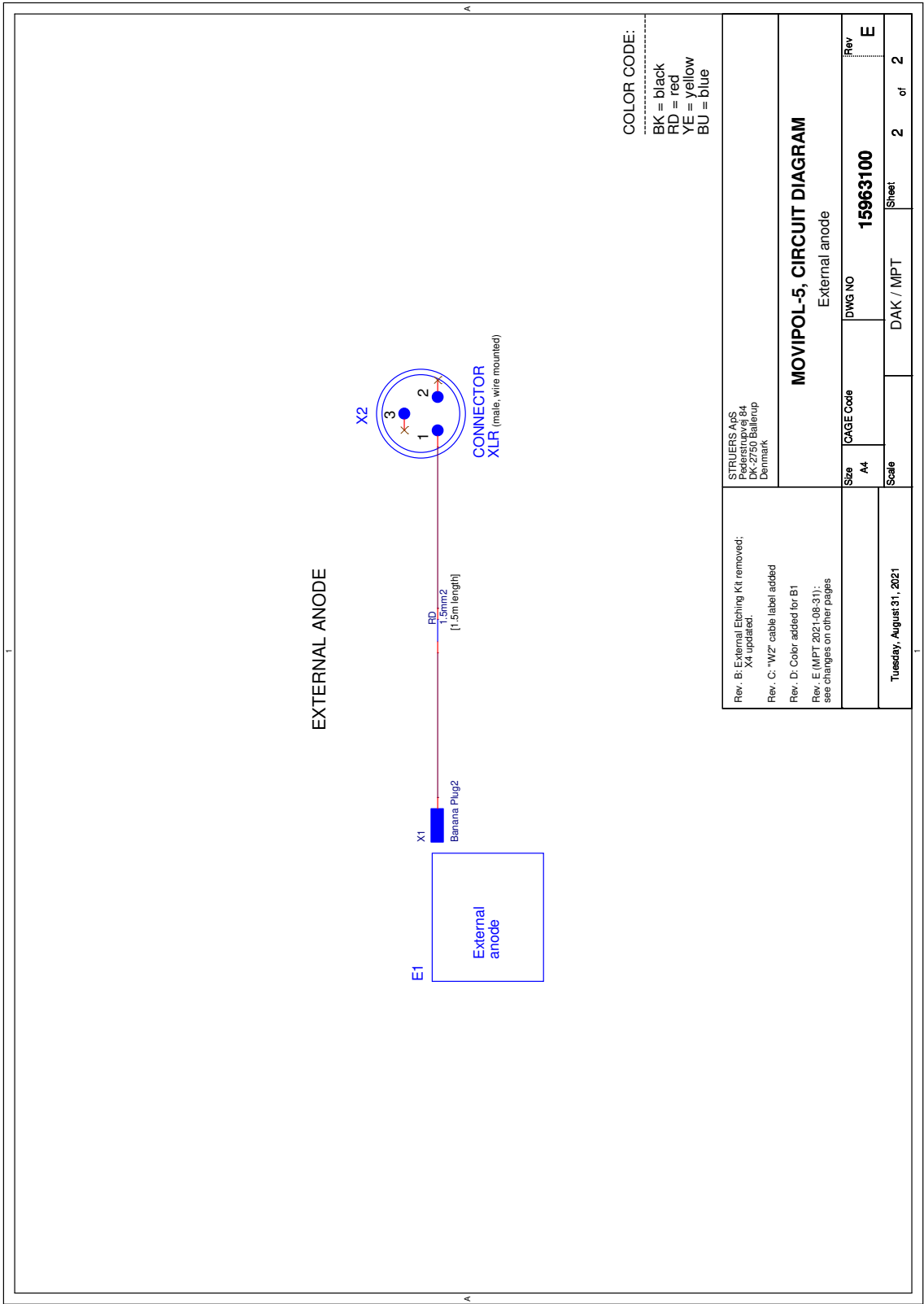

COLOR CODE:
 BK = black
 RD = red
 YE = yellow
 BU = blue

STRUERS APS Pedestrupvej 84 DK-2750 Ballerup Denmark		MOVIPOL-5, CIRCUIT DIAGRAM External anode	
Rev. B: External Etching Kit removed; X1 updated. Rev. C: "W2" cable label added Rev. D: Color added for B1 Rev. E (MPT 2021-08-31): see changes on other pages	Size A4	CAGE Code 15963100	Rev E
Tuesday, August 31, 2021	Scale	DAK / MPT	Sheet 2 of 2

15963102 B

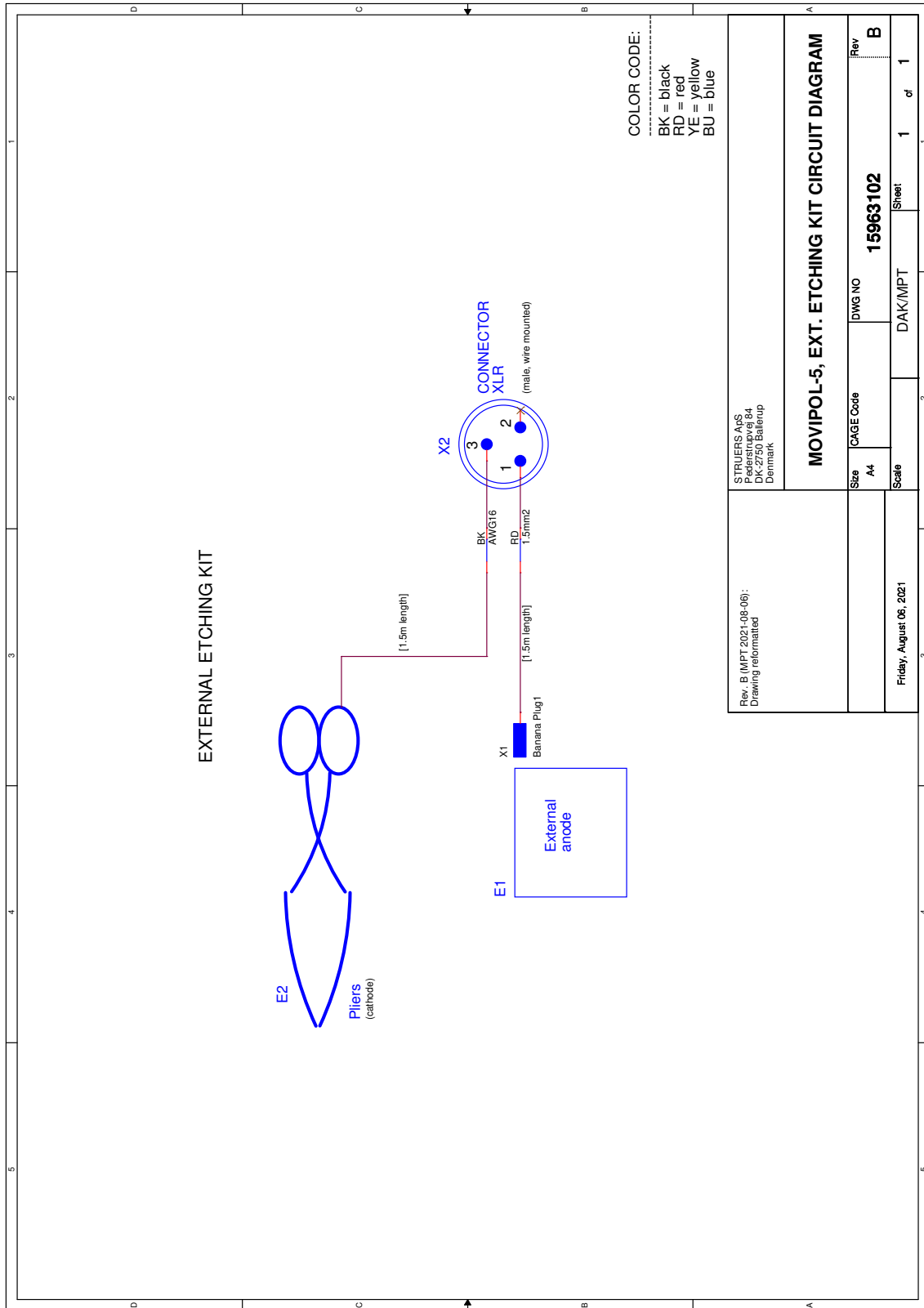

STRUERS APS Pederstrupvej 84 DK-2750 Ballerup Denmark	
Rev. B (MPT.2021.08-06): Drawing reformatted	
Size A4	DWG NO 15963102
Scale	DAK/MPT
Friday, August 06, 2021	Sheet 1 of 1

10.4 Legal and regulatory information

FCC notice

This equipment has been tested and found to comply with the limits for a Class B digital device, pursuant to part 15 of the FCC Rules. These limits are designed to provide reasonable protection against harmful interference in a residential installation. This equipment generates, uses and can radiate radio frequency energy and, if not installed and used in accordance with the instructions, may cause harmful interference to radio communications. However, there is no guarantee that interference will not occur in a particular installation. If this equipment does cause harmful interference to radio or television reception, which can be determined by turning the equipment off and on, the user is encouraged to try to correct the interference by one or more of the following measures:

- Reorient or relocate the receiving antenna.
- Increase the separation between the equipment and receiver.
- Connect the equipment into an outlet on a circuit different from that to which the receiver is connected.

11 Manufacturer

Struers ApS
Pederstrupvej 84
DK-2750 Ballerup, Denmark
Telephone: +45 44 600 800
Fax: +45 44 600 801
www.struers.com

Responsibility of the manufacturer

The following restrictions should be observed, as violation of the restrictions may cause cancellation of Struers legal obligations.

The manufacturer assumes no responsibility for errors in the text and/or illustrations in this manual. The information in this manual is subject to change without notice. The manual may mention accessories or parts not included in the supplied version of the equipment.

The manufacturer is to be considered responsible for effects on safety, reliability, and performance of the equipment only if the equipment is used, serviced, and maintained in accordance with the instructions for use.

Struers ApS
Pederstrupvej 84
DK-2750 Ballerup, Denmark

Declaration of Conformity

EU / UE / EL / EC / EE / ES / EÜ / AB

Manufacturer / Производител / Výrobce / Producent / Hersteller / Κατασκευαστής / Fabricante / Tootja / Valmistaja / Fabricant / Proizvođač / Gyártó / Fabricante / Gamintojas / Ražotājs / Fabrikant / Producent / Fabricante / Producătorul / Výrobca / Proizvajalec / Tilverkare / 販売元 / 제조사 / Producent / Изготовитель / Imalatçı / 制造商

Декларация за съответствие Prohlášení o shodě Overensstemmelseserklæring Konformitätserklärung Δήλωση συμμόρφωσης Declaración de conformidad Vastavusdeklaratsioon	Vaatimustenmukaisuusvakuutus Déclaration de conformité Izjava o skladnosti Megfelelőségi nyilatkozat Dichiarazione di conformità Atitikties deklaracija Atbilstības deklarācija	Verklaring van overeenstemming Deklaracja zgodności Declaração de conformidade Declarație de conformitate Vyhlásenie o zhode Izjava o skladnosti Intyg om överensstämmelse	適合宣言書 적합성 선언서 Samsvarserklæring Заявление о соответствии Uygunluk Beyanı 符合性声明
--	---	--	---

Name / Име / Název / Navn / Name / Όνομα / Nombre / Nimetus / Nimi / Nom / Naziv / Névv / Nome / Pavadinimas / Nosaukums / Naam / Nazwa / Nome / Denumirea / Názov / Ime / Namn / 名前 / 제품명 / Наименование / Adı / 名称	MoviPol-5
Model / Модел / Model / Model / Modell / Μοντέλο / Modelo / Mudel / Malli / Modèle / Model / Modell / Modello / Modelis / Modelis / Model / Model / Modelo / Modelul / Model / Model / Modell / モデル / 모델 / Modell / Модель / Model / 型号	N/A
Function / Функция / Funkce / Funktion / Funktion / Λειτουργία / Función / Functio / Toiminto / Fonction / Funkcija / Funkció / Funzione / Funkcja / Funkcja / Functie / Funkcja / Função / Functia / Funkcia / Funkcija / Funktion / 機能 / 기능 / Funksjon / Назначение / Fonksiyon / 功能	Portable, electrolytic polishing and etching device, either on-site or by means of replica for laboratory examination.
Type / Тип / Typ / Type / Typ / Τύπος / Tipo / Túüp / Tyyppi / Type / Tip / Tipus / Tipo / Tipas / Tips / Type / Typ / Tipo / Tipul / Typ / Тип / Type / 種類 / 유형 / Type / Тип / Tür / 类型	05966104 MoviPol-5 with battery pack
Serial no. / Серийн номер / Výrobní číslo / Seriennummer / Seriennummer / Σειριακός αριθμός / N.º de serie / Seerianumber / Sarjanro / No de série / Serijski broj / Sorozatszám / N. serie / Serijos Nr. / Sērijas Nr. / Serienr. / Numer seryjny / N.º de série / Nr. serie / Výrobné č. / Serijska št. / Seriennummer / シリアル番号 / 일련번호 / Serienr. / Серийный номер / Serí no. / 序列号	

CE
Module H, according to global approach

en We declare that the product mentioned is in conformity with the following directives and standards:	es Declaramos que el producto mencionado cumple con las siguientes directivas y normativas:	it Dichiariamo che il prodotto citato è conforme ai seguenti standard e direttive:	pt Declaramos que o produto mencionado está em conformidade com as seguintes normas e diretivas:	ja 弊社はこの指定製品が以下の指令および基準に適合することを宣言します。
bg Декларираме, че посоченият продукт е в съответствие със следните директиви и стандарти:	et Kinnitame, et nimetatud toode vastab järgmistele direktiividele ja standarditele:	lt Pareiškiame, kad nurodytas gaminy s atitinka šias direktyvas ir standartus:	ro Declarăm că produsul menționat este în conformitate cu următoarele directive și standarde:	ko 해당 선언서 상의 제품은 다음 지침 및 기준에 적합함을 선언합니다.
cs Tímto prohlašujeme, že uvedený výrobek je v souladu s následujícími směrnici a normami:	fi Vakuutamme, että mainuttu tuote on seuraavien direktiivien ja standardien mukainen:	lv Mēs apstiprinām, ka minētais produkts atbilst šādām direktīvām un standartiem:	sk Vyhlasujeme, že uvedený výrobok je v súlade s týmito smernicami a normami:	no Vi erklærer at produktene som er nevnt er i samsvar med følgende direktiver og standarder:
da Vi erklærer herved, at det nævnte produkt er i overensstemmelse med følgende direktiver og standarder:	fr Nous déclarons que le produit mentionné est conforme aux directives et normes suivantes :	nl Wij verklaren dat het vermelde product in overeenstemming is met de volgende richtlijnen en normen:	sl Potrjujemo, da je omenjeni izdelek v skladu z naslednjimi direktivami in standardi:	ru Настоящим заявляем, что указанная продукция отвечает требованиям перечисленных далее директив и стандартов:
de Wir erklären, dass das genannte Produkt den folgenden Richtlinien und Normen entspricht:	hr Izjavljujemo da je spomenuti proizvod sukladan sljedećim direktivama i standardima:	pl Oświadczamy, że wymieniony produkt jest zgodny z następującymi dyrektywami i normami:	sv Vi intygar att den angivna produkten överensstämmer med följande direktiv och standarder:	tr Belirtilen ürünün aşağıdaki direktiflere ve standartlara uygun olduğunu beyan ederiz:
el Δηλώνουμε ότι το εν λόγω προϊόν είναι σύμφωνο με τις ακόλουθες οδηγίες και πρότυπα:	hu Kijelentjük, hogy jelen termék megfelel a következő irányelveknek és szabványoknak:			zh 我们特此声明上述产品符合以下指令和标准:

2006/42/EC	EN ISO 12100:2010, EN ISO 20643:2008, EN 60204-1:2018, EN 60204-1-2018/Corr.:2020
2006/66/EC	
2011/65/EU	EN 63000:2018
2014/30/EU	EN 61000-3-2:2014, EN 61000-3-3:2013, EN 61000-6-1:2007, EN 61000-6-3:2007, EN 61000-6-3-A1:2011, EN 61000-6-3-A1-AC:2012
Additional standards	NFPA 79, FCC 47 CFR Part 15 Subpart B

Authorized to compile technical file/
Authorized signatory

Date: [Release date]

