

# Duramin-4

## Instruction Manual

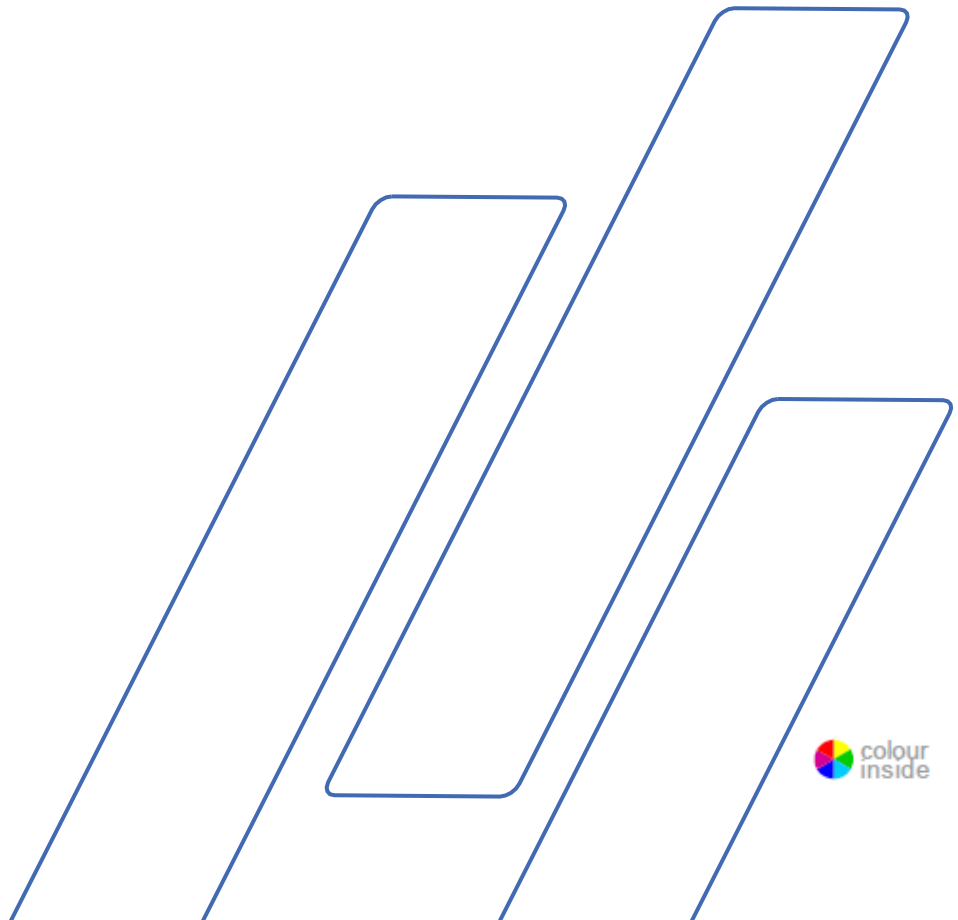

*Duramin-4*  
*Instruction Manual*

<b>Table of Contents</b>	<b>Page</b>
Intended use .....	4
Safety Precaution Sheet.....	5
Icons and typography .....	7
User´s Guide.....	9
Contents of the Declaration of Conformity .....	69

## **Intended use**

Manual Micro/Macro hardness tester for Micro/Macro hardness testing of solid materials.

The machine is designed to be used with indenters specially designed for this purpose and fixed in the turret of the test head.

Samples are secured on a fixed anvil or optional XY-stage.

For load ranges 10 gf - 2 kgf or 1 kgf - 62.5 kgf

The hardness tester meets the applicable DIN, ISO-EN, ASTM and JIS standards.

### **Models:**

Duramin-4 M1

Duramin-4 M2

The machine is for use in a professional working environment (e.g. a materialography laboratory).



### **IMPORTANT**

READ the instruction manual carefully before use.  
Keep a copy of the manual in an easy-to-access place  
for future reference.

## **Duramin-4**

### **Safety Precaution Sheet**



#### **To be read carefully before use**

1. The machine must be installed in compliance with local safety regulations.
2. The operator(s) must read the Safety and User's Guide sections of this manual and the relevant sections of the manuals for any connected equipment and accessories.
3. The machine must be placed on a safe and stable support. Failure to do so can affect the proper working and cause the equipment to fall down and/or cause accidents and injuries. All safety functions and guards of the machine must be in working order.
4. Do not modify this equipment. Doing so can cause fire and/or electric shock.
5. Do not twist or damage the power cords. Damaged power cords can cause fire and/or electric shock.
6. Do not disassemble this equipment. Doing so can cause electric shock.
7. Do not operate the equipment at a voltage other than the power voltage that is indicated. Doing so can cause fires.
8. Do not allow the machine to become wet. Fires can occur if water gets inside the equipment.  
If water or other liquid does get inside the equipment, turn off the power to the equipment's main unit, disconnect the power supply, and call technical service.
9. If malfunctions, smoke or unusual noises are observed - turn off the power, disconnect the power supply and call technical service.
10. Do not connect/ disconnect power with wet hands. Doing so can result in electric shock.

- 11.** Crushing hazard.  
Keep hands away from the area around the moving test unit.
- 12.** Disconnect the power supply prior to any cleaning, maintenance or service.  
Failure to do so can result in electric shock.
- 13.** Do not block the ventilation. Blocking the ventilation can cause heat to accumulate inside the machine, which in turn, can generate fire.
- 14.** Do not open any panel on the machine.  
High voltages exist inside the machine and may cause electrical shocks to personnel.



**WARNING**

Ignoring this information and mishandling of the equipment can lead to severe bodily injuries and material damage.

---

The equipment should only be used for its intended use and as detailed in the Instruction Manual.

The equipment is designed for use with accessories supplied by Struers. If subjected to misuse, improper installation, alteration, neglect, accident or improper repair, Struers will accept no responsibility for damage(s) to the user or the equipment.

Dismantling of any part of the equipment, during maintenance, service or repair, should always be performed by a qualified technician (electromechanical, electronic, mechanical, pneumatic, etc.)

---

## Icons and typography

The following icons and typographic conventions are used in this instruction manual:

### Icons and Safety Messages



#### **ELECTRICAL HAZARD**

indicates an electrical hazard which, if not avoided, will result in death or serious injury.



#### **DANGER**

indicates a hazard with a high level of risk which, if not avoided, will result in death or serious injury.



#### **WARNING**

indicates a hazard with a medium level of risk which, if not avoided, could result in death or serious injury.



#### **CAUTION**

indicates a hazard with a low level of risk which, if not avoided, could result in minor or moderate injury.



#### **CRUSHING HAZARD**

indicates a crushing hazard which, if not avoided, could result in minor, moderate or serious injury.

### General Messages



#### ***Important or Note***

indicates a risk of damage to property, or the need to continue with special care.



#### ***Information or Tip***

indicates additional information and tips.

## Colour Inside Logo



The 'colour inside' logo on the cover page of this Instruction Manual indicates that it contains colours which are considered to be useful for the correct understanding of its contents.

Users should therefore print this document using a colour printer.

## Typographic conventions

<b>Bold type</b>	indicates button labels or menu options in software programs
<i>Italic type</i>	indicates product names, items in software programs or figure titles
■ Bullets	indicates a necessary work step



## Disposal

Equipment marked with a WEEE symbol  contain electrical and electronic components and must not be disposed of as general waste.

Please contact your local authorities for information on the correct method of disposal in accordance with national legislation.



# User's Guide

Table of Contents	Page
<b>1. Getting Started</b>	
Unpacking Duramin-4 .....	11
Location.....	12
Lifting Duramin-4 .....	13
Placing Duramin-4 .....	14
Levelling .....	14
Removing the Lifting Bar .....	14
Checking the Contents.....	15
Getting Acquainted with Duramin-4 .....	16
USB Drive.....	18
Rear plate .....	18
Noise Level.....	18
Power Supply .....	19
Connecting the Tester .....	19
Installing an XY-Stage.....	20
Connecting the Touchscreen.....	21
Installing the Eyepiece .....	22
<b>2. Basic Operations</b>	
Front Panel Controls.....	23
Software.....	24
Start-up .....	24
Zeroing the Eyepiece .....	26
Main Screen .....	27
Diameter Entry and Eyepiece Setup.....	29
Setting Limits.....	30
Measurement list.....	34
Load program.....	35
Exporting measurements to USB.....	37
Measurement Data/Statistics, Hardness Scale and Load Selection.....	39
Saving a Measurement.....	41
Conversions.....	42
Time/date and time/date setup.....	43
To Delete 1 or ALL Saved Measurements .....	44
Light control.....	44
Settings.....	45
Operating mode.....	46
Calibrate touchscreen .....	46
Language .....	48
Calibrating the Indenter.....	48
Turret position selection & turret setup.....	50
Status bar.....	51
Dwell time and progress indication & Shape correction setup.....	51

### **3. Performing a Measurement**

Check that the turret is correctly setup.....	54
Select the hardness scale and desired load.....	54
Set the Dwell time and Shape correction .....	54
Choose the objective with the highest magnification .....	54
Position the specimen.....	54
Focus on the specimen.....	54
Performing an Indentation.....	55
Measuring the diameters.....	56

### **4. Trouble shooting..... 58**

### **5. Maintenance**

General Cleaning.....	60
Daily Maintenance .....	60
Weekly Maintenance.....	60
Cleaning Surfaces.....	60
Weekly Inspection.....	60
Yearly Maintenance .....	61
Testing Safety Devices.....	61
Service.....	61
Replacing the Fuse.....	62
Calibration .....	62

### **6. Struers Knowledge..... 63**

### **7. Transport..... 64**

### **8. Technical Data..... 65**

## 1. Getting Started

### Unpacking Duramin-4



**Important**

Refer to the **HOW TO UNPACK** instructions delivered with Duramin.

**Take care** whilst handling Duramin.  
Do not expose to external impact.  
Do not tilt over 30 degrees.  
Do not touch the turret.

- Carefully open and remove the top of the packing crate.

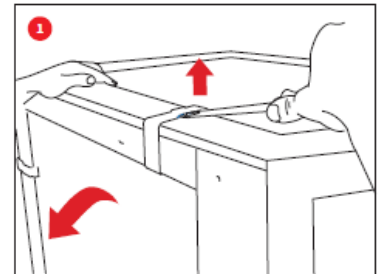

- Remove one side of the packing crate.
- Remove the touchscreen, accessories case and other loose items.

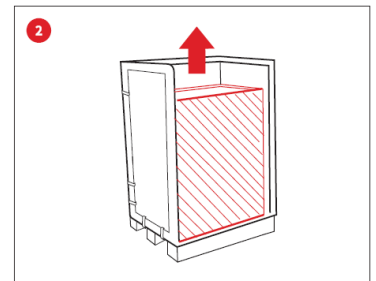

- Carefully lift the foam pieces to access Duramin.

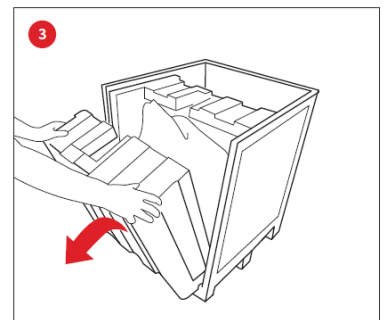

**Store the packing crate and foam packaging for use whenever Duramin is transported/re-located. Failure to use the original packaging and fittings could cause severe damage to the tester and will void the warranty.**

- Remove the plastic covering.

## Location

- Duramin must be placed close to the power supply.
- Duramin is designed to be placed on a rigid, stable workbench with a horizontal surface.  
The workbench must be able to carry at least 130 Kg / 280 lbs.

Minimum workbench dimensions:

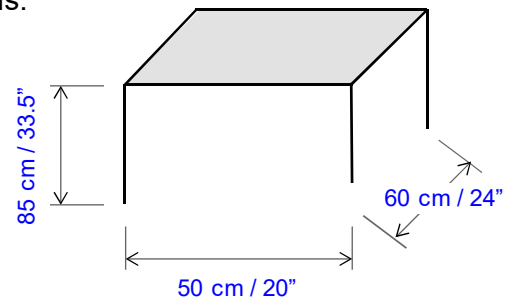

## Vibration-free Location

- Install Duramin in a vibration-free location.



**Important**  
Vibrations can lead to inaccurate measurements and must be avoided.

A simple way of detecting vibrations is to set up a tray of water and watch for ripples on the surface.



**Information**  
Sources of vibration can include:  
Passers-by (persons walking past), a road with heavy traffic, cranes, equipment generating vibrations, equipment generating sound (acoustic vibration), exposure to wind or air conditioning fans.

If possible, install the hardness tester on the ground floor of a building and away from exits or doorways.

## Lifting Duramin-4

A crane and lifting straps are required to lift the machine from the packing crate. The crane should have a minimum lifting capacity of 120 kg.



***Important***

**Take care** whilst handling Duramin.  
Do not expose to external impact.  
Do not tilt over 30 degrees.  
Do not touch the turret.

- Check that the crane has a free pathway from the lifting point to the final location.
- Place the lifting straps securely around the lifting bar.
- Carefully lift Duramin out of the packing crate.
  
- Check whether the 4 adjustable vibration dampers are installed.  
If not:
  - Mount the dampers and adjust the height of the dampers so that they are of equal height.
  - Place Duramin-4 into its final location

## Placing Duramin-4 Levelling

To eliminate possible wear and tear on the tester's mechanical structure, the tester should be levelled once it is in its final location.

- Check that the anvil / XY-stage is level.

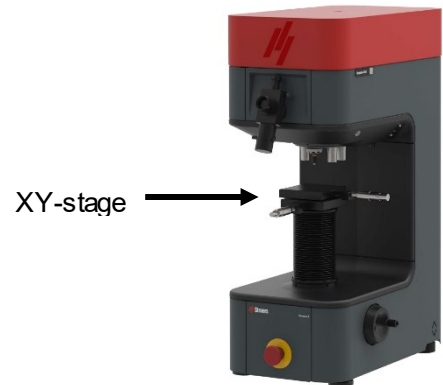

If not:

- Turn the vibration damper in the rear right hand corner, to level the anvil/XY-stage.



## Removing the Lifting Bar

- Support the lifting bar and remove the screws and washers from both sides of the bar.



**Important**  
Keep the lifting bar, screws and washers for use whenever the machine is to be relocated.

## Checking the Contents

In the packing crate you should find the following parts:

- 1 Duramin-4 (Hardness Tester)
- 1 Accessories Case
- 1 Touchscreen

### Accessories Case Standard Accessories



- Indenter(s) and eyepiece
- 1 Anvil
- 1 Manual XY-Stage
- 2 Power cables
- 1 Spare fuse
- 1 Certificate of calibration on USB

### Optional Accessories

Please consult your order confirmation to check that all the accessories ordered are included in the delivery.



**Information**  
Some components or parts may be packaged separately and may not be included in the accessory case or may have been installed on the hardness tester.



**Information**  
The actual packaging and accessories may appear different to those shown in the picture.

*Duramin-4  
Instruction Manual*

**Getting Acquainted  
with Duramin-4**

Take a moment to familiarise yourself with the location and names of the Duramin-4 components.



Tester

Touchscreen



Duramin-4  
Instruction Manual

Hardness Tester Body



- ① USB port
- ② 6 position turret
- ③ XY-stage
- ④ Spindle cover
- ⑤ Z-axis hand wheel
- ⑥ Eyepiece
- ⑦ Emergency stop

Power Connections



- ⑧ Main power switch
- ⑨ Main power connection / Fuse
- ⑩ Connection for Touchscreen
- ⑪ Data output port

*Duramin-4*  
*Instruction Manual*

*USB Drive*



The USB drive contains direct and indirect calibration documents.

*Rear plate*

Information on the model number, serial number, weight, date of manufacture, and power requirements can be found on the type plate on the back of the machine.

**Noise Level**

Less than 70<sup>1</sup> dB (A) measured at idle running, at a distance of 1.0 m/39.4" from the machine.  
Use hearing protection if exposure to noise exceeds levels set by local regulations.

---

<sup>1</sup> "The figures quoted are emission levels and are not necessarily safe working levels. Whilst there is a correlation between the emission and exposure levels, this cannot be used reliably to determine whether or not further precautions are required. Factors that influence the actual level of exposure of the workforce include the characteristics of the workroom and the other sources of noise, i.e. the number of machines and other adjacent processes and the length of time for which an operator is exposed to the noise. Also, the permissible exposure level can vary from country to country. This information, however, will enable the user of the machine to make a better evaluation of the hazard and risk."  
(ref. EN ISO 16089:2015)

## Power Supply



### ELECTRICAL HAZARD

- Switch the power off when installing electrical equipment.
- The machine must be earthed.
- Check that the mains voltage corresponds to the voltage stated on the type plate on the side of the machine.  
Incorrect voltage may result in damage to the electrical circuit.

### Connecting the Tester

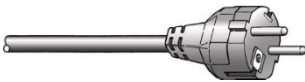

Duramin-4 is shipped with 2 types of Mains cables:

The 2-pin (European Schuko) plug is for use on single-phase connections.

If the plug supplied on this cable is not approved in your country, then the plug must be replaced with an approved plug. The leads must be connected as follows:

Yellow/green: earth (ground)

Brown: line (live)

Blue: neutral

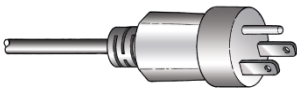

The 3-pin (North American NEMA 5-15P) plug is for use on single-phase connections.

If the plug supplied on this cable is not approved in your country, then the plug must be replaced with an approved plug. The leads must be connected as follows:

Green: earth (ground)

Black: line (live)

White: line (live)

### Connection to the Machine



- Connect the power cable to the machine. (IEC 320 connector).
- Connect to the mains power supply.

## Installing an XY-Stage



### **Information**

The XY-stage is usually delivered already mounted on the machine.

To install a different XY-stage:

- Move the spindle to its top position.
- Switch the machine OFF (to prevent short circuiting the electronics).
- Loosen the four screws holding the bellow in place.

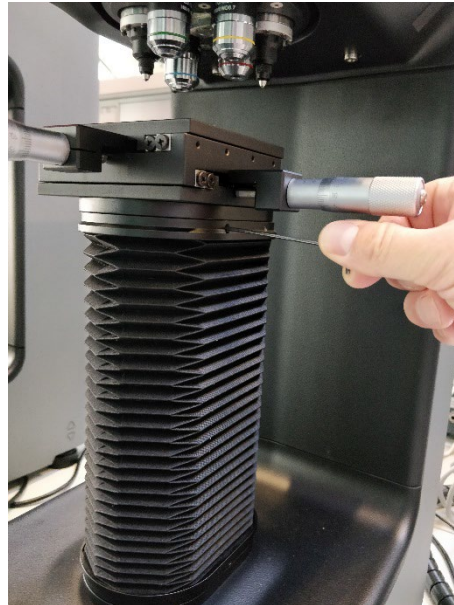

- Push the bellow down and remove the four screws from the mounting plate.



*Duramin-4*  
*Instruction Manual*

- Remove the old XY-stage.
- Mount the new XY-stage on the mounting plate.
- Verify that the XY-stage is level.
- Tighten the fixation screw to secure the stage in place.
- Re-attach the bellow.
- Perform a few hardness tests on a test block to securely seat the stage.

**Connecting the Touchscreen**

- Connect the communication cable from the touchscreen to the rear of Duramin-4.

## Installing the Eyepiece



### **Important**

The eyepiece is a delicate precision instrument.  
Handle with care.

- Remove the protection cover of the lens tube.
- Gently insert the eyepiece optical tube into the lens tube.



- Carefully rotate the eyepiece around its axis whilst sliding into the lens tube.  
Rotate the eyepiece slightly to the left and right around its axis, to ease it into position.

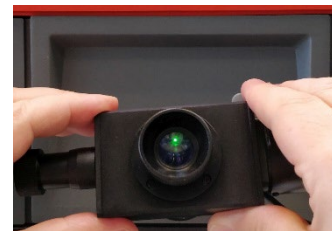

Do not force the eyepiece into place.

- Turn the eyepiece until it is in a horizontal position with the data cable located to the right.
- Connect the eyepiece data cable to the connector on the tester.



## 2. Basic Operations

### Front Panel Controls



### MAIN SWITCH

The main switch is located on the rear of the machine.  
The main switch will be illuminated when the power is turned on.



The EMERGENCY STOP is located on the front of the machine.

Emergency Stop

- Push the red button to Activate.
- Turn the red button clockwise to Release.



### **Important**

Do not use the Emergency stop for operational stop of the machine during normal operation.

BEFORE releasing (disengaging) the Emergency stop, investigate the reason for activating the Emergency stop and take any necessary corrective action.

## Software

Duramin-4 is configured and operated using the attached touchscreen running the Duramin software.

## Start-up

- Switch Duramin-4 on using the main switch at the rear. The Duramin software will initialize and the following splash screen will appear on the touchscreen:



The splash screen will be visible for about 5 seconds.



### ***Tip***

Make sure that the emergency stop is not activated during start-up.

If the emergency stop is activated during start-up:

- Release the emergency stop.
- If Duramin-4 does not start, switch the machine on again using the main switch.



A warning will then appear *Turret will rotate*.

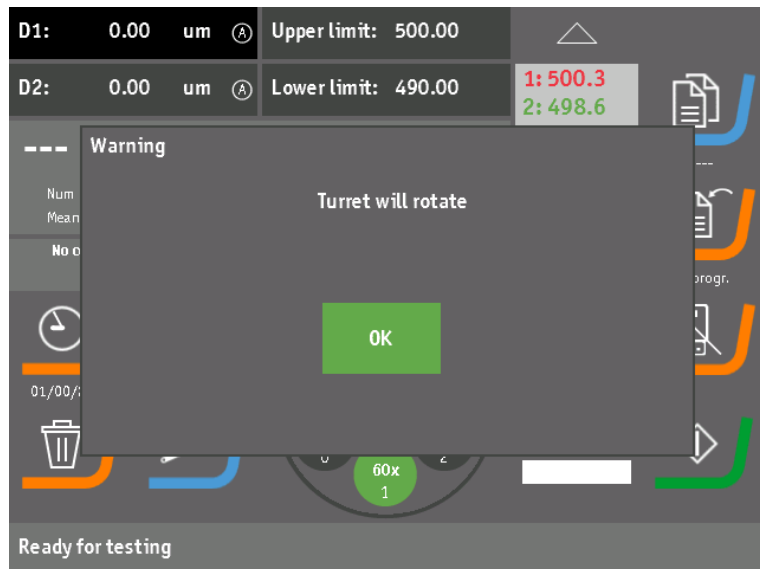

- Check that the indenter and objectives will not touch the workpiece when the turret is rotated.
- Press **OK** to continue.  
The load motor will retract and the turret will rotate to the start position.
- Push gently in the middle of the designated buttons for tester operation. Do not use force. Do not use sharp objects.

The **Zero eyepiece** pop-up will then appear:

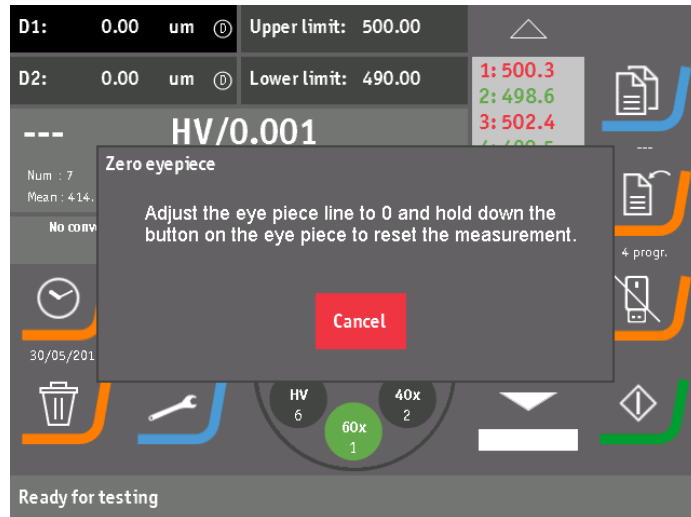

- Press **Cancel** to skip this step.  
e.g. if adjustment of the light intensity is required to see the specimen surface clearly.



**Information**  
The eyepiece can be zeroed later by pressing the eyepiece button for more than 2 seconds.

## Zeroing the Eyepiece

- Look through the eyepiece and adjust the rotary knobs on the eyepiece until both guiding lines touch each other – they shouldn't overlap.
- Press and hold down the button on the eyepiece for more than 2 seconds to confirm zeroing and to continue.
- The zeroing screen will disappear and the digital eyepiece is ready to use.

**Main Screen**

The main screen will then appear.

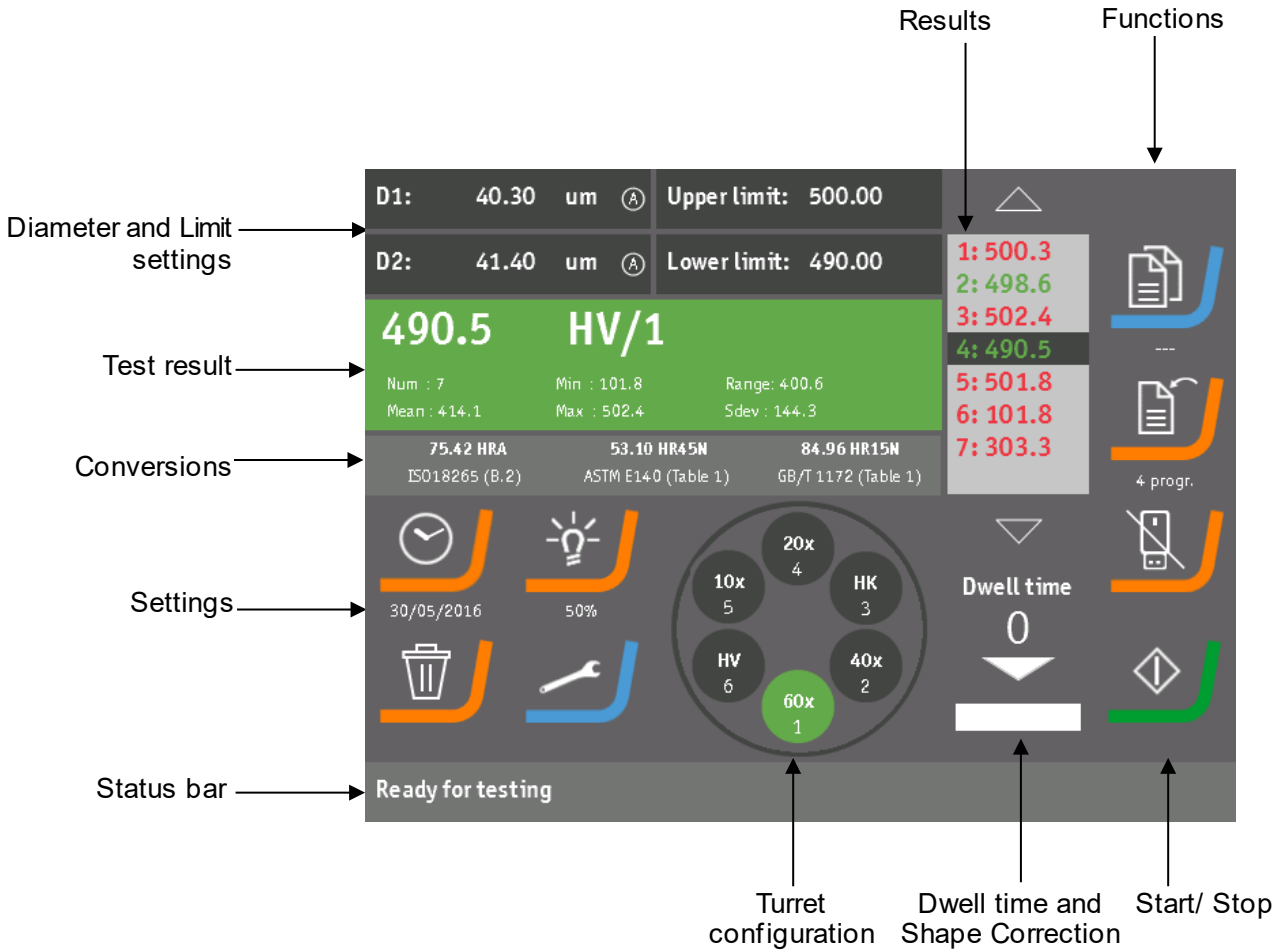

**Information**  
The actual screens may appear different from the screens in this manual.

There are a number of software screens for configuring Duramin-4. In general, When changes to the configuration are made, pressing the **OK** button will activate the changes. This configuration will be recalled when the tester is switched on again.

Pressing **Cancel** will abort any changes and keep the previous settings .

e.g. The *Upper limit setup screen*:



#### Alternative functions

A number of fields and buttons on the touchscreen have an alternative function which is activated when they are pressed for more than 2 seconds.

e.g. The *Upper limit entry field*

The *Enter limit* screen will appear when the *Upper limit entry* field is pressed briefly:

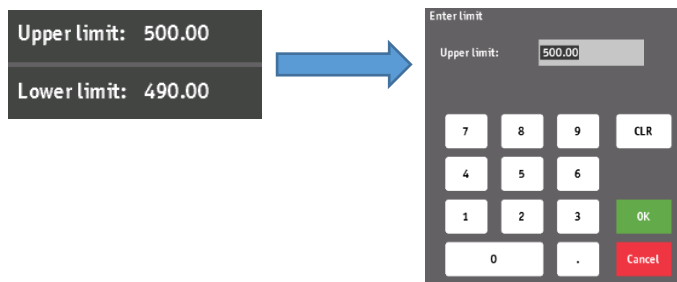

However, the *Upper limit setup screen* will appear when the *Upper limit entry* field is pressed for longer than 2 seconds:

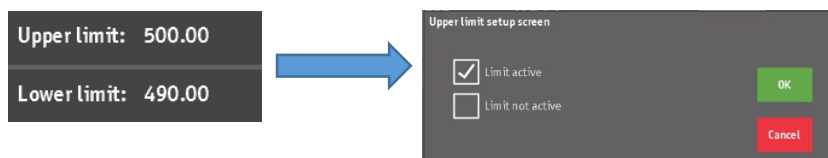

**Diameter Entry and Eyepiece Setup**

Depending on the hardness scale selected (used), one or two diameters must be entered:

Hardness scale

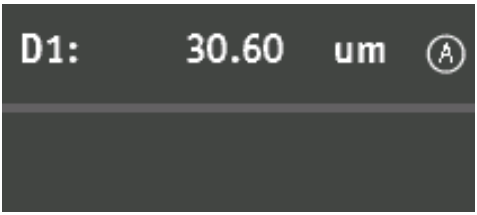
Vickers	Two diameters (D1 and D2) are required 
Knoop	One diameter (D1) is required 
Brinell	Two diameters (D1 and D2) are required 

Eyepiece

<b>Digital</b>	Diameters are automatically updated when the eyepiece button is pressed.
----------------	--

The eyepiece type is indicated by an 'D' showing that a digital eyepiece is used.

## Setting Limits

When a hardness value has been calculated or a measurement is selected in the measurement list, the background of the measurement data and statistics field colours either black, green or red. The colour depends on whether the hardness value is within the upper and lower limit and whether one or both limits are set to active. The hardness values in the measurement list will also be coloured depending on whether the hardness value is within or outside the current limits.

The *Limit entry* fields are used to enter the upper and lower limit individually:

Upper limit: 500.00

Lower limit: 490.00

The *Limit entry* fields must be active before a limit value can be set.

- Press one of the *Limit entry* fields for more than 2 seconds.  
The *Upper limit setup* screen will appear:

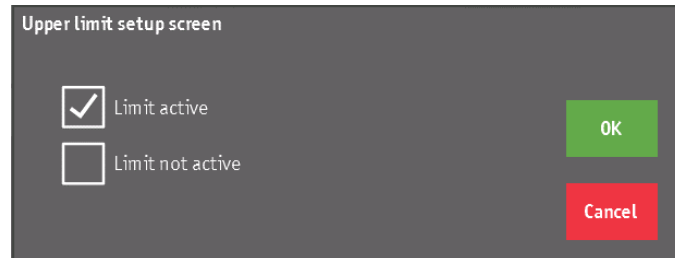

- Set the selected limit to active or inactive.
- Press **OK** to save the setting.
- Press **Cancel** to abort.

To enter a limit value, touch the corresponding limit field briefly and enter the value.



**Information**  
The limit must be active to be able to set a limit value.

With the upper limit active:

- Press the *Upper limit entry* field.  
The *Enter limit* screen will appear to enter the desired limit value.

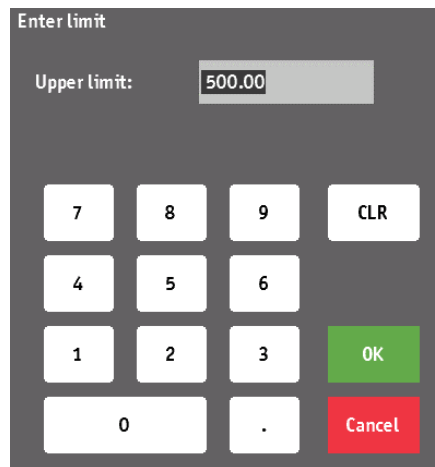

When the lower limit is set active, touch the *Lower limit entry* field briefly to enter a new lower limit value.



**Information**  
The lower limit value may not be higher than the upper limit value and the upper limit value may not be lower than the lower limit value.

Here are some examples of limit settings and how they affect the way that the hardness value and measurements are displayed:

*Duramin-4  
Instruction Manual*

Example 1: Both limits inactive.

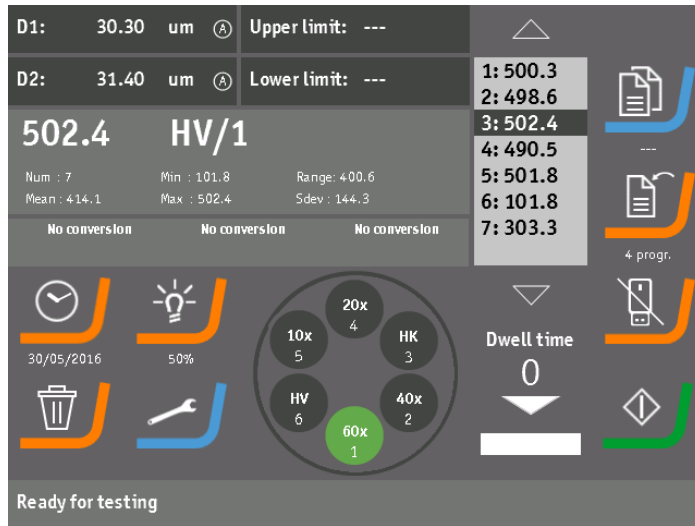

Example 2: Only the upper limit is active.

All hardness values below the upper limit are marked green. All hardness values above the upper limit are marked red.

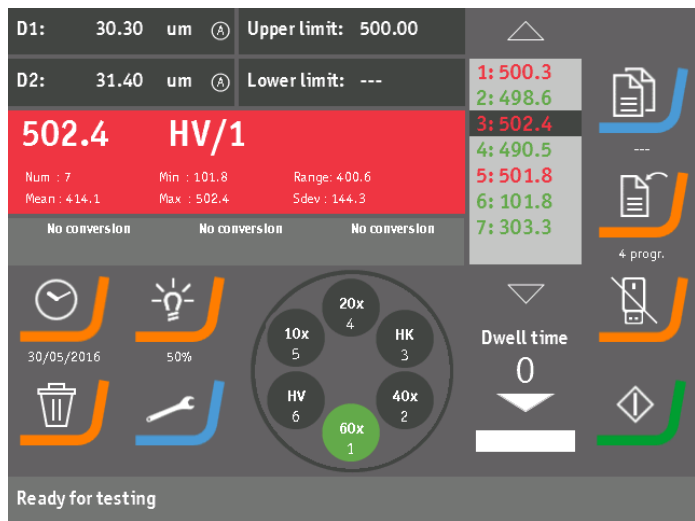





## Measurement list



The measurement list contains all saved measurements. The tester remembers all saved measurements, even after power off.

**Information**  
Up to a maximum of 50 measurements can be saved.

The measurement list can be browsed by touching the up or down arrows.

Measurements can be selected from the list by touching the desired list item. When touching or selecting a measurement from the list, the hardness value and diameters of the selected measurement item is displayed.

For Vickers and Knoop, the dwell time is also shown if it is a non-standard dwell time (< 10 or > 15 seconds).

The picture below is an example of the information shown when a measurement is selected from the list:

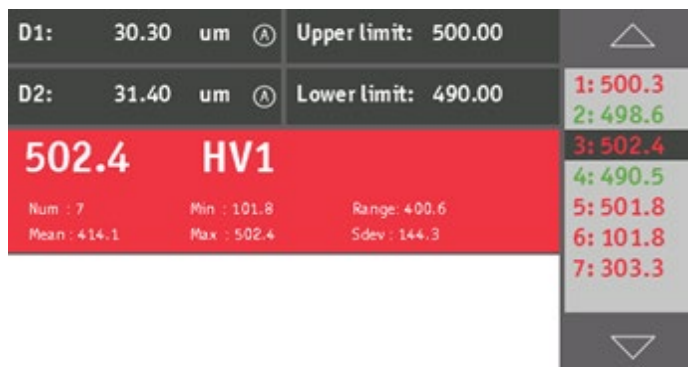

## Load program



The software enables the user to store settings in custom programs for frequently used testing tasks/objects. This will reduce the setup time of the tester.

The load program button is used to recall a stored program. The “---“ below the load icon indicates that currently no program is loaded, or that a loaded program has been overruled by changing the settings.

- Press **Load program** and the *Load program with name* screen appears:

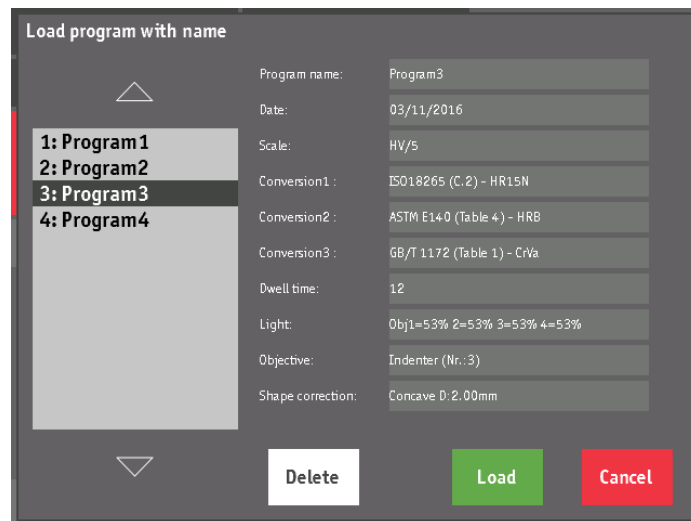

The screen shows all the stored programs. Browse through the list of programs by touching the up or down arrows. Programs can also be selected by touching the desired list item. The detailed settings information about the selected program is shown in the right part of the screen.

## Deleting a program

To delete a program a from the list:

- Select the list item and press **Delete**.  
A pop-up will appear to confirm the delete action:

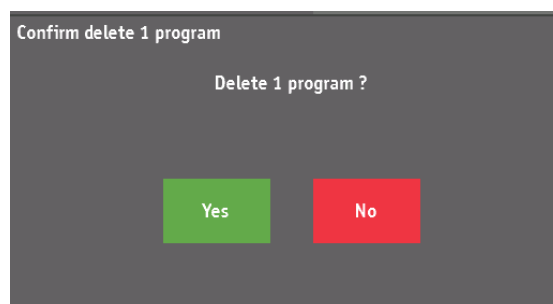

### Deleting all programs

- Select the list item and press **Delete** for more than 2 seconds. A pop-up will appear to confirm the delete action:

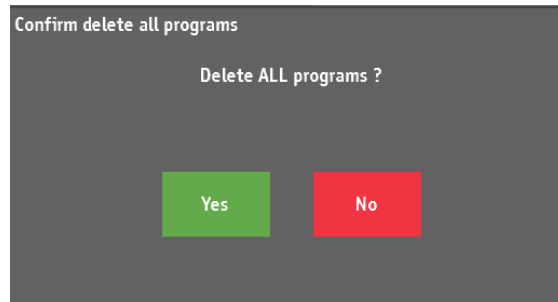

### Loading a program



To load one of the saved programs:

- Select the program and touch the **Load program** button. When a saved program has been loaded, the name of the program is shown below the Load program icon.

### Saving program



To save the current set of settings as a program and attach a name to this program:

- Press the **Save program** button.



**Information**  
A maximum of 50 programs can be stored.

A pop-up will appear with an automatically generated program name:

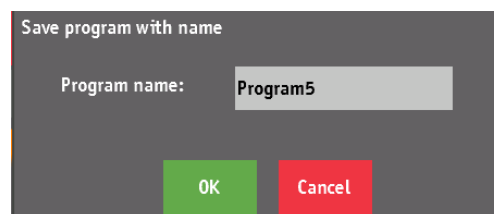

To change the program name:

- Touch the **Program name** field. An alphanumeric keypad appears in the *Save program with name* screen.
- Enter a name for the new program.

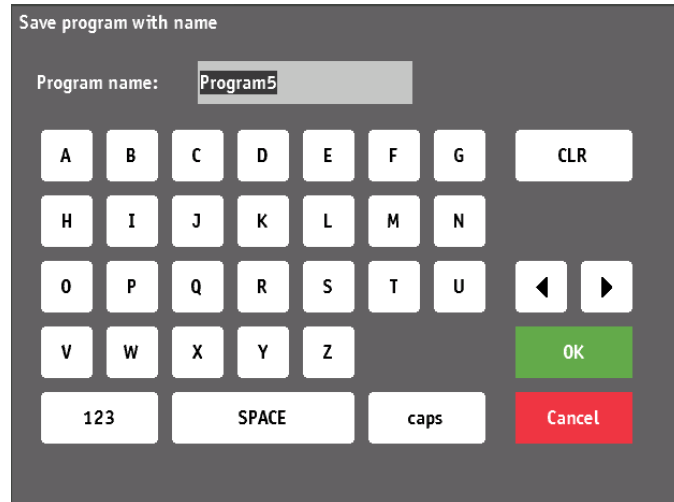

- Press **OK** to save the changed name.
- Press **OK** again to save the program, the current settings are saved using the entered name.

The **Save program** icon will change to show the number of saved programs.

### Exporting measurements to USB

All measurements in the measurement list, conversions and statistics can be exported to an USB stick by selecting the **Export to USB** button.

A line through the USB stick icon, indicates that the USB stick is not detected:

USB stick not detected



USB stick detected



#### **Important**

After inserting the USB stick, the tester needs several seconds to detect the stick. If the stick is not detected, re-insert the stick. The USB stick has to be formatted for the FAT(32) file system. Other file systems, such as NTFS or exFAT, will not work.

When touching the **Export to USB** button, the measurements are saved to a file called "report.txt" in the root folder of the USB stick.

- If this file already exists, a pop-up message appears: **"Overwrite file?"** Press **Yes** to over write the file. A second message will the appear, "File was written".
- Press **OK** to continue.

Example of the "report.txt" file.

Duramin-4  
Instruction Manual

```
STRUERS
Duramin-4 M2
TEST RESULT LIST
OPERATOR      : .....
PART NR.      : .....
DATE          : 07/02/2018
TIME         : 08:56:06
HARDNESS SCALE : HV
CONVERSION 1  : None
              :
CONVERSION 2  : None
              :
CONVERSION 3  : None
              :
FORCE         : 5000.000g
DWELL TIME    : 10 sec
MEASUREMENTS : 6
AVG           : 734.2
MAX           : 749.2
MIN           : 705.4
S. DEV       : 14.02
RANGE        : 43.80
SINGLE VALUES
1.  738.1  HV/5
2.  744.4  HV/5
3.  735.3  HV/5
4.  732.8  HV/5
5.  705.4  HV/5
6.  749.2  HV/5
```

**Measurement Data/Statistics,  
Hardness Scale and Load  
Selection**

The measurement and statistics field shows either the calculated hardness value after entering the diameters or the hardness value of a saved measurement when it is selected in the measurement list. When the limits are active, the colour of the measurement and statistics field indicates whether the hardness value is within the set limits or not.

The statistics data calculated over all saved measurements is also shown.

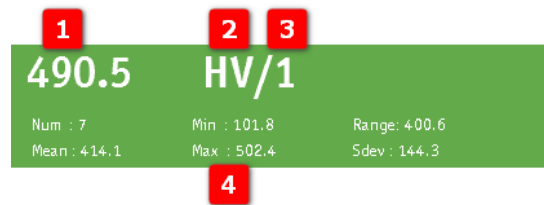

<b>1</b>	<b>Hardness value</b>	Calculated after entering the diameters or from the measurement that is selected in the measurement list.  When the hardness value shows “---“, this means that a new measurement is created, but no diameters have been entered yet, so no calculation is done yet.												
<b>2</b>	<b>Hardness scale</b>	The hardness scale selected.												
<b>3</b>	<b>Hardness load</b>	The load selected.												
<b>4</b>	<b>Statistics</b>	<p>Statistics data over all saved measurements in the measurement list.</p> <table border="1"> <tr> <td><b>Num</b></td> <td>number of saved measurements</td> </tr> <tr> <td><b>Min</b></td> <td>minimum value of the saved measurements.</td> </tr> <tr> <td><b>Max</b></td> <td>maximum value of the saved measurements.</td> </tr> <tr> <td><b>Range</b></td> <td>difference between the minimum and maximum value.</td> </tr> <tr> <td><b>Mean</b></td> <td>mean value calculated over the saved measurements.</td> </tr> <tr> <td><b>Sdev</b></td> <td>standard deviation calculated over the saved measurements</td> </tr> </table>	<b>Num</b>	number of saved measurements	<b>Min</b>	minimum value of the saved measurements.	<b>Max</b>	maximum value of the saved measurements.	<b>Range</b>	difference between the minimum and maximum value.	<b>Mean</b>	mean value calculated over the saved measurements.	<b>Sdev</b>	standard deviation calculated over the saved measurements
<b>Num</b>	number of saved measurements													
<b>Min</b>	minimum value of the saved measurements.													
<b>Max</b>	maximum value of the saved measurements.													
<b>Range</b>	difference between the minimum and maximum value.													
<b>Mean</b>	mean value calculated over the saved measurements.													
<b>Sdev</b>	standard deviation calculated over the saved measurements													

**Information**

When a non-standard dwell time (> 10 or > 15seconds) is used for Vickers or Knoop, this dwell time is added to the hardness, scale and force information. E.g.: 100 HV/1/16s => hardness=100 Vickers using a test force of 1kg and a dwell time of 16 seconds.

- Touch the **Measurement and statistics** field to open the *Select hardness scale and force* screen.

Select hardness scale and force

Vickers	1g	3g	5g	10g	15g
Knoop	20g	25g	50g	100g	200g
Brinell	300g	500g	1kg	2kg	2.5kg
Rockwell	3kg	4kg	5kg	10kg	20kg
HBT	30kg	40kg	50kg	100kg	120kg
HVT					
HBall					

OK

Cancel



**Information**

Some hardness scales and forces are disabled depending on the tester type.

- Select the desired hardness scale in the left column.
  - Select the desired force from the right table.
  - Press **OK** to save the setting.
- Or.
- Press **Cancel** to discard any changes.



### Saving a Measurement

To save a measurement, there are 2 possible modes: Automatic or manual.

To set the desired save mode.

- Press **Settings**.  
The *General setup* screen will appear:

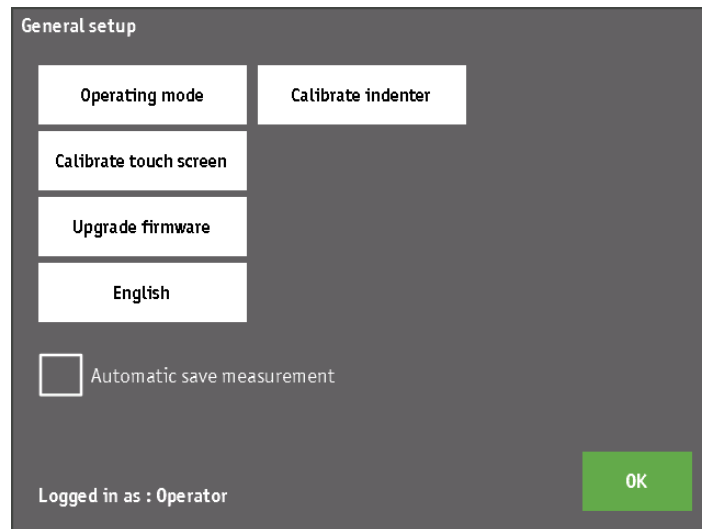

Check the *Automatic save measurement* box to enable or disable automatic save mode.

<b>Automatic mode</b>	The hardness value will be saved automatically to the measurement list.
<b>Manual mode</b>	the hardness value is saved by the user.

### Adding measurements Manually

- Press the Measurement and statistics field for more than 2 seconds.  
A pop-up appears with the question: "Add measurement to the list?".
- Press **Yes** to save the measurement.

## Conversions

The tester can store and show 3 user-selectable conversions of the current hardness value into 3 other hardness scales. The current conversions are shown in the *Conversions field*:

75.42 HRA	53.10 HR45N	84.96 HR15N
ISO18265 (B.2)	ASTM E140 (Table 1)	GB/T 1172 (Table 1)

To change one of the 3 conversions, press the corresponding area in the *Conversions field*.

Example: Conversion 1

- Select the first conversion value, the *Select conversion* screen will appear:

Select Conversion - Nr.: 1

ISO18265	(A.1) Unalloyed and low-alloy steels and cast iron	HV	HRF
	(B.2) Quenching and tempering steels in the quenched tempered conditions	HBW	HR45T
ASTM E140	(B.3) Quenching and tempering steels in the untreated, soft annealed or normalized conditions	HRC	HR30T
	(B.4) Quenching and tempering steels in quenched conditions	HRA	HR15T
GB/T 1172	(C.2) Cold working steels	HR45N	Rm
	(D.2) High speed steels	HR30M	
None	(F.2) Non-ferrous metals and alloys	HR15N	
		HRB	

OK

Cancel

The screen shows the current conversion data.

To change the conversion:

- Select the desired standard in the left column.
- Select the desired metal type in the 2nd column and then select the desired conversion scale in the last column.
- Press **OK** to save the setting.

The conversion selection screen will close and the new conversion is shown in the conversions field.

When the hardness value cannot be converted into the selected conversion scale, the converted hardness value is displayed as “---“. This happens when the hardness value is outside the range of the chosen conversion scale or when a new measurement is not complete.

**Time/date and time/date setup** The time/date button shows the current time of day and date.



Setting the Date/Time Format

- Press the **Time/date** button briefly.  
The *Date/Time adjust* screen will appear:

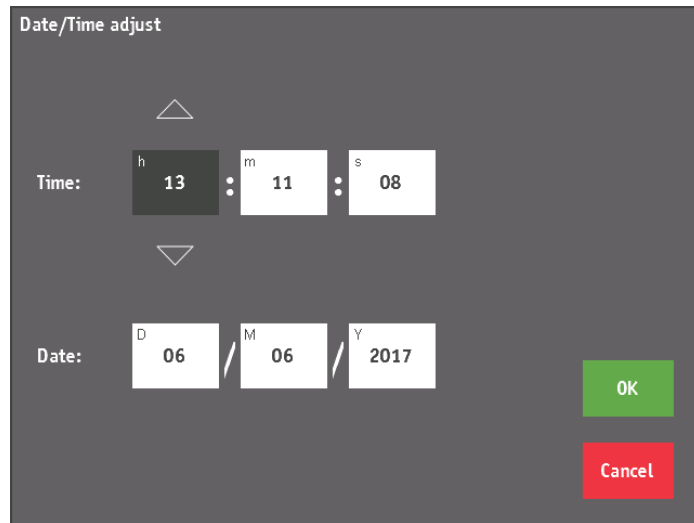

Select the fields to set the values.

For example, to set the seconds:

- Touch the seconds field and adjust the value by pressing the up and down arrows. Keep pressing the arrows until the correct value is displayed.
  - Press **OK** to save the setting.
- Or
- Press **Cancel** to discard any changes.

Changing the Date/Time Format

- Press the Date/Time icon for more than 2 seconds.  
The *Date/Time setup* screen will appear:

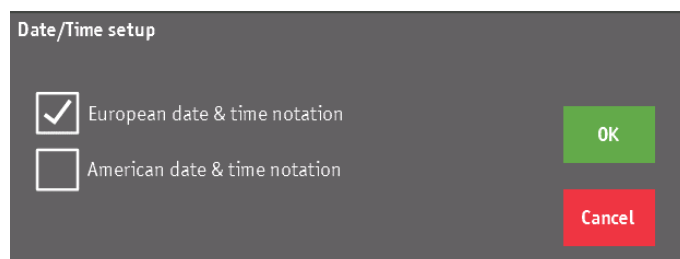

- Select the desired format, European or American.

European format



American format



## To Delete 1 or ALL Saved Measurements



The **Delete** button is used to delete a saved measurement or all saved measurements at once from the measurement list:

To delete 1 selected measurement:

- Press the measurement or use the up/down arrows of the measurement list to select a measurement.
- Press **Delete**.
- Press **OK** to confirm this action.

To delete all measurements:

- Press **Delete** for more than 2 seconds.
- Press **OK** to confirm this action.

## Light control



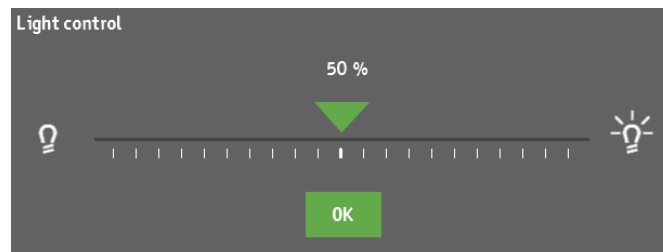

The **Light control** icon is used to set the light level for the Through-The-Lens (TTL) light. The current light level, in percent, is shown in the button. The light level is stored for each objective independently, so each objective has its own light level setting.

- Press the **Light control** icon. The Light control pop-up will appear:



- Press and drag the arrow on the slider to set the light intensity.

To adjust the light intensity by 1%:

- Touch the buttons to the left and right of the slider.
  -  To increase light intensity.
  -  To decrease light intensity.
- Press **OK** to save the setting.

## Settings



The Settings icon is used to change general settings of the tester, upgrade firmware or for calibration purposes.

The current login level is shown in the settings button. The standard login level at start up is "Operator".

Press Setup to view the settings screen:

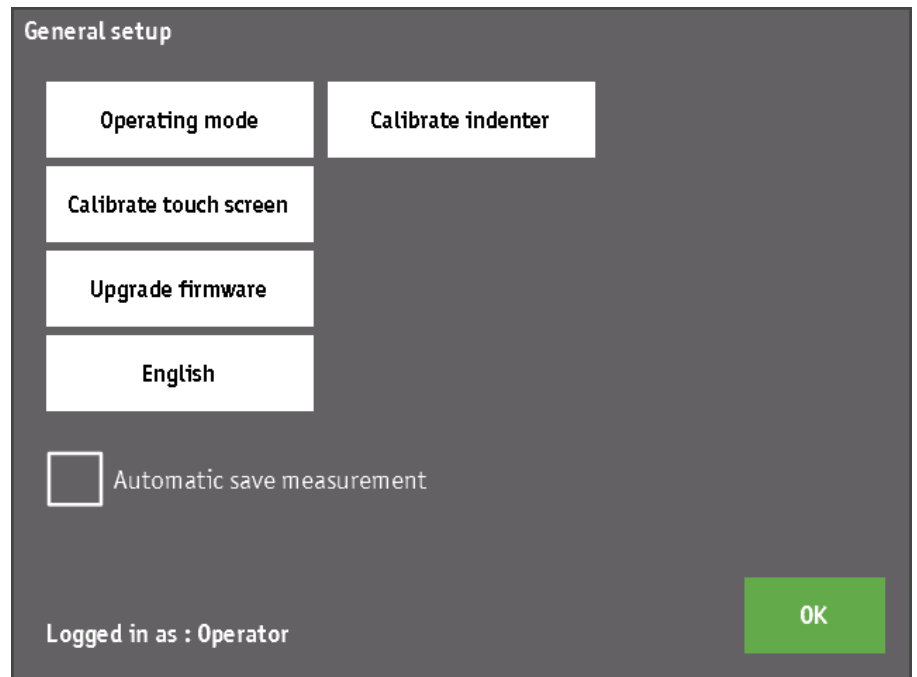

The settings screen gives access to the following functions:

<b>Operating mode</b>	To change the operating mode. This function is used by service technicians.
<b>Calibrate touchscreen</b>	To re-calibrate the touchscreen.
<b>Upgrade firmware</b>	To install new firmware using an USB stick.
<b>Language selection</b>	To select another language. All texts will be shown in the chosen language.
<b>Calibrate indenter</b>	To calibrate the indenter length when the indenter has been changed or replaced.

## Operating mode

- Press **Operating mode** to change the current operator level. The *Operating mode* pop-up will appear-
- Press **Change** to change to a different user level.

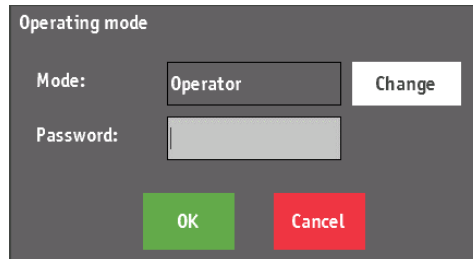

The image shows a dark grey pop-up window titled "Operating mode". It contains two input fields: "Mode:" with a dropdown menu currently showing "Operator", and "Password:" with an empty text box. To the right of the "Mode:" dropdown is a white button labeled "Change". At the bottom of the window are two buttons: a green "OK" button and a red "Cancel" button.

Each operating mode is protected by a password. Enter the correct password in the field then confirm the change by pressing **OK**.

## Calibrate touchscreen

- Press **Calibrate touchscreen** to calibrate the screen. A calibration screen will appear.

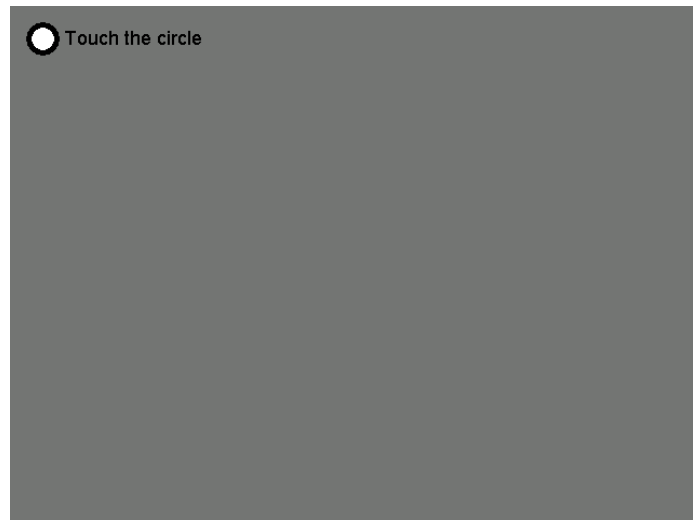

- Touch the circle at the top left corner of the screen. The following screen will appear:

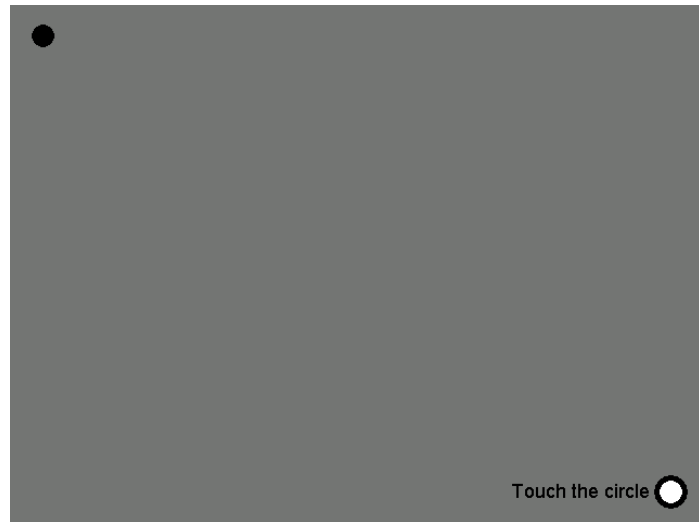

- Touch the circle at the bottom right corner of the screen. The following screen will appear:



To accept and store the new calibration data:

- Press **Accept calibration...** in the middle of the screen within 10 seconds.  
To cancel the calibration, wait for 10 seconds and the calibration screen will automatically disappear without saving the new calibration data.

## Language

To change the language:

- Press the **Language field** on the settings screen briefly, until the language of your choice appears.

## Calibrating the Indenter

When the indenter has been replaced or another type of indenter has been installed, the indenter length has to be calibrated again, so the tester knows the exact length of the indenter. The software needs the exact length of the indenter in order to determine the position at which the indenter will touch the specimen.

To calibrate the indenter:

- Press **Calibrate indenter** in the settings screen.  
The *Indenter calibration* pop-up will appear:

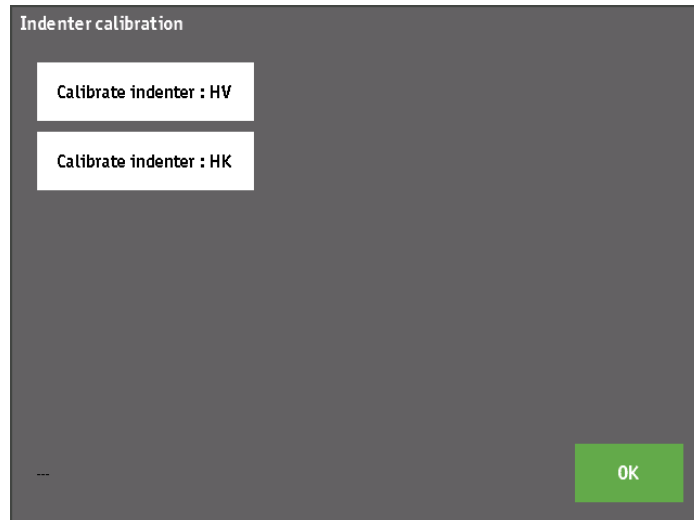

The screen show one or more buttons, depending on how many indenters are installed.

- Select the indenter to be calibrated (in this example a Vickers or a Knoop indenter).  
A pop-up will appear.

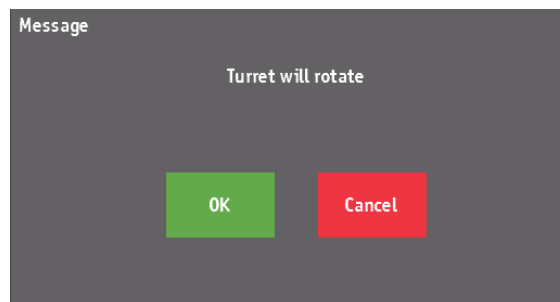

During calibration, the objective with the highest magnification will be used to focus on the specimen.



- Check that the objective will not collide with the specimen, then press **OK** to continue.  
The turret rotates and selects the objective with the highest magnification.

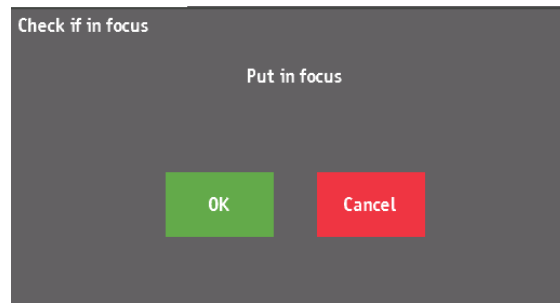

Look through the eyepiece and adjust the height of the specimen until the specimen surface is in focus. When the specimen is in focus, press **OK**. The indenter length is now calibrated.

When the calibration is completed, the following screen appears:

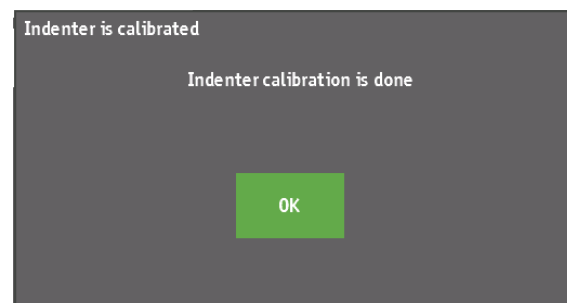

- Press **OK** to complete the calibration procedure.

## Turret position selection & turret setup

The turret with all the turret positions is displayed on the overview screen. The screen shows the turret positions seen from the top, the order of the positions is identical with the order in the physical turret.

Each turret position is numbered and indicates whether there is an indenter or an objective lens (with magnification) in that position. The turret position marked in green shows the position that is currently selected:

The rotation of the turret is always clockwise.

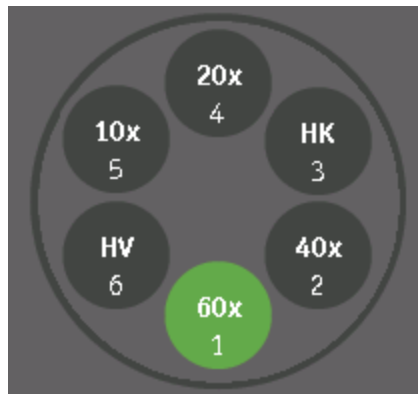

- Select a turret position to move the turret to this position.

The *Turret configuration* must be modified after changing an indenter or objective.

To change the turret configuration:

- Press one of the turret positions for more than 2 seconds. The *Turret setup* screen will appear.

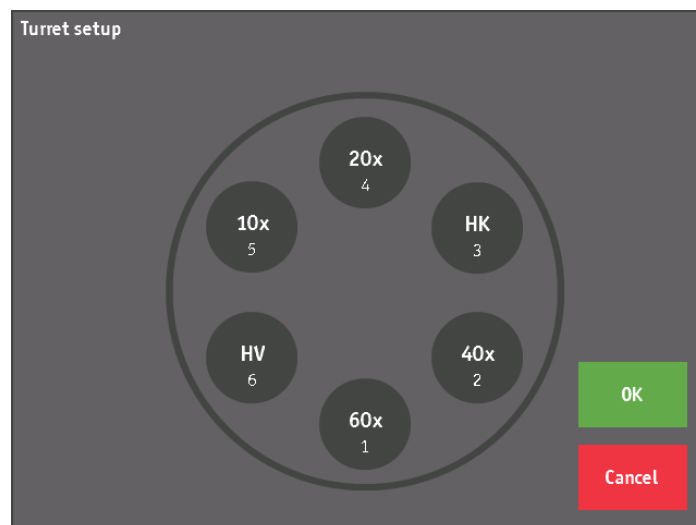

To change the objective or indenter type of one of the turret positions, press this position repeatedly, until the desired type is shown.

With each touch, the type will change.

The type "---" is used to indicate that the corresponding turret position is not used and thus empty.

When the correct type is shown:

- Press **OK** to save the setting and return to the main screen.
- Press **Cancel** to discard any changes.

## Status bar



Ready for testing

The status bar at the bottom of the overview screen is used to show: the current state of the tester :

“Ready for testing”

“Positioning turret”

“Applying test force”

“Dwelling”

“Retracting indenter”

“Positioning objective”

“Ready for measurement”

informational messages about the actions of the user

warning messages for actions of the user that are not allowed, possible or relevant at that moment.

Informational and warning messages are shown in red to attract attention.

## Dwell time and progress indication & Shape correction setup



The dwell time and progress are combined in the dwell time and progress indication field:

The lower part of the field shows a triangular shape that represents the indenter and a rectangular/concave or convex shape that represents the specimen surface.

When an indentation is started, the progress indication will show the position of the indenter while moving towards the specimen surface. When the indenter touches the specimen, the progress indication changes to a bar graph showing the measured load until the selected load is reached:



To set the dwell time:

- Press the **Dwell time** field.  
The *Adjust dwell time* screen will appear:

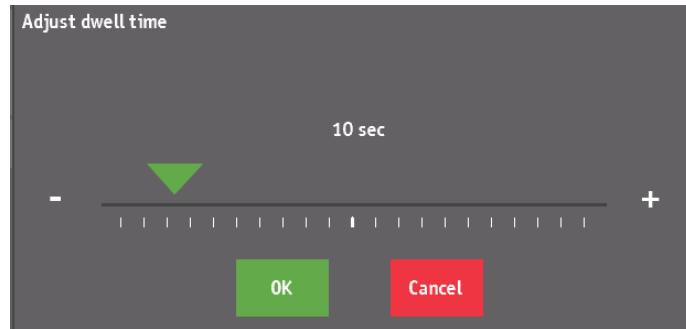

To adjust the Dwell time:

- Press and drag the arrow on the slider.

To adjust the light intensity by 1 second:

- Press the **+** or **-** on the left and right of the slider.
- Press **OK** to save the setting.

Or

- Press **Cancel** to discard any changes.

To set the Shape correction:

- Press the **Dwell time** field for more than 2 seconds.  
The *Shape correction* screen will appear:

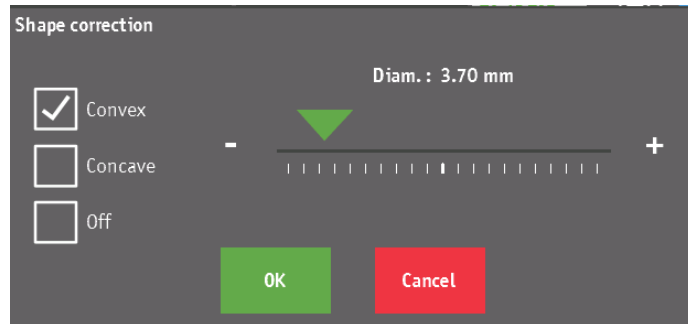

**Information**

The shape correction can only be set when a hardness scale is selected for which the shape correction is relevant. Shape correction is not relevant for Knoop hardness measurements.

Select the shape by touching one of the 3 checkboxes at the left of the screen:

- Convex
- Concave
- Off

When convex or concave are selected, the shape diameter can be set using the slider for coarse adjustments or the + and – buttons for fine adjustments.

- Press **OK**, to set the shape correction and return to the main screen.
- Or
- Press **Cancel** to return to the main screen without saving the changes.

The dwell time and progress indication field will show the selected shape correction as follows:

Shape correction: Off



Shape correction: Convex  
Shape diameter : 3.7 mm



Shape correction: Concave  
Shape diameter: 3.7 mm



### 3. Performing a Measurement

- |  |  |
|--|--|
| <b>Check that the turret is correctly setup</b>            | ■ Check that the objective and indenter types on the screen match with the objectives and indenter that are actually installed in the turret.  |
| <b>Select the hardness scale and desired load</b>          | ■ Select a hardness scale and the desired load that will be applied for the indentation.   |
| <b>Set the Dwell time and Shape correction</b>             | ■ Set the dwell time and set the shape correction to the correct shape and shape diameter (when this is applicable for the selected hardness scale).   |
| <b>Choose the objective with the highest magnification</b> | ■ Check that the specimen is positioned at a height so that the turret can freely rotate without touching the specimen. Use the spindle hand wheel to adjust the height.<br>■ Select the turret position on the screen that holds the objective with the highest magnification. This is the best objective to focus on the specimen surface using the eyepiece.  |
| <b>Position the specimen</b>                               | ■ Ensure that the specimen surface condition complies with the required standards.<br>■ Put the specimen in the centre of the flat anvil or XY-Stage. The specimen surface must be in parallel with the flat anvil. Use an appropriate clamp or fixture for specimens with complicated geometric shapes.<br>■ Adjust the light level so the specimen surface is clearly visible when looking through the eyepiece. |
| <b>Focus on the specimen</b>                               | ■ Adjust the spindle hand wheel until the specimen surface is in focus, giving a sharp and crisp image when looking through the eyepiece.<br>■ Adjust the light level if necessary.  |

***Important***

Adjust the hand wheel with care, so the indenter or objectives do not collide with the specimen, because this can cause severe damage to the turret.

## Performing an Indentation



### **Important**

To prevent collision between the specimen and the objective or the indenter, make sure that the specimen is positioned properly and is in focus before pressing Start.



### **CRUSHING HAZARD**

**Risk of crushing hands and fingers.**

Keep hands away from the testing area.



- Press **Start** to perform an indent.  
The tester will automatically select the indenter that corresponds with the chosen hardness scale and start the indentation process.  
The turret will rotate to select the indenter.

The start icon will change into a red **STOP** button that can be used to stop/abort the indentation process.

The status bar shows the different phases of the indentation process. The progress of the indent is indicated by a bar, showing the current force.

The indenter will slowly move down towards the specimen surface and the indenter position is shown on the screen.

The text message in the status bar shows the current state of the indentation process.

When the indenter touches the specimen surface and the load is applied, the dwell time starts counting down to zero. When the dwell time has expired, the indenter is retracted and the turret selects the last used objective.

The tester is now ready to measure the diameters and calculate the hardness value.



- Press **Stop** to stop the indentation process.  
The indenter will immediately be retracted back to the start position.



### **Information**

When the indenter is not defined, "--" is shown in the indenter position of the turret. When starting an indent, the message: "Indenter is not present" appears in the status bar. To be able to start an indentation, an indenter needs to be defined in the turret setup.

## Measuring the diameters

The following section describes how to enter diameters to calculate Vickers, Knoop or Brinelle hardness.

For Vickers, two diameters are measured and entered to calculate the hardness value. For Knoop, only one diameter is measured and entered to calculate the hardness value.

The eyepiece has to be zeroed in order to obtain valid measurements. See [Zeroing the Eyepiece](#) earlier in the manual.

### Diameter D1

- Measure diameter D1.  
(The diameter of the horizontal diagonal of the indentation).
- Press the button on the eyepiece to store D1.  
For Vickers, the diameter field for D2 is automatically selected after storing D1.  
For Knoop, the hardness value will be calculated after measuring and storing D1.

### Diameter D2

(For Knoop hardness measurements, only one diameter is measured, go directly to the next step, 'Hardness Calculation'.)

- Measure diameter D2.  
(The diameter of the vertical diagonal of the indentation).

If the difference between D1 and D2 becomes higher than 5% during the measurement, the background of the diameter fields is coloured red. This indicates that the diameter difference is outside specification.

- Press the button on the eyepiece to store D2 and to start the hardness calculation.

### Hardness Calculation

The hardness value is automatically calculated.

The hardness result is shown on the screen. When the hardness value is out of range for the selected scale, the hardness will be displayed as "---".



Automatic save measurement –  
**OFF**

To store the hardness value in the measurement list:

- Press the **Measurement and Statistics** field for more than 2 seconds.

Automatic save measurement –  
**ON**

The hardness value will automatically be added at the end of the measurement list.



**Information**

A maximum of 50 stored measurements can be saved.



**Information**

When the diameters are entered and the calculated hardness value shows “—”, this means that the hardness value is invalid or out of range. The hardness can be out of range when the diameters are very large or very small. The hardness value is invalid when the shape correction is set to convex or concave with a very small or zero diameter.

## 4. Trouble shooting

Error	Explanation	Action
The screen turns RED and one or more error message are shown.	A technical problem has occurred. e.g. bad connection, malfunctioning sensor or electronic problem.	Make a note of the error message(s), as this gives valuable information about the cause of the problem. Contact Struers Service.
	The power has been switched OFF then ON too quickly.	- Restart the tester. If the error remains, contact Struers Service.
Start-up failure	The power cable is not inserted or not properly inserted.	Check that the power cable is properly inserted.
	Fuse has blown.	Replace the fuse.
	The power has been switched OFF then ON too quickly.	- Restart the tester. If the error remains, contact Struers Service.
The tester does not power up correctly.	The Emergency stop is activated	De-activate the Emergency stop.
	The battery for the time/date clock must be replaced.	Contact Struers Service Contact Struers Service to replace the battery.
Indentation will not start when Start is pressed.	No indenter configured in the turret setup.	Touch a turret position for more than 2 seconds. Then select an indenter for turret position 2.
After doing an indentation, no indent can be found/seen.	The indenter is too far away from the object surface, so it does not reach the surface.	Use an objective and focus on the surface of the object. The indenter will then be at the correct height above the surface.
	The objective is out of focus, so the surface cannot be seen properly.	Try adjusting the focus.
	The indenter is damaged.	Contact Struers Service.
After doing an indentation, the indent has an irregular shape	The indenter is damaged.	Contact Struers Service.
	The specimen surface is too rough / dirty.	Polish the specimen surface.
	The specimen is tilted.	Make sure the specimen surface is horizontal.
	The specimen surface is curved.	Make an indent at the highest position of the specimen surface curve.

*Duramin-4  
Instruction Manual*

<b>Error</b>	<b>Explanation</b>	<b>Action</b>
An USB stick is inserted but the tester does not detect it (indicated by line through the USB stick icon).	The tester is not set up to use the Export to USB stick option.	Set the option to export the measurement data to USB stick, by touching the <b>Export to USB stick</b> button for more than 2 seconds.
	The USB stick is not detected properly.	Restart the tester.
	The USB stick is not formatted for use with the FAT32 file system.	Format the USB stick for use with the FAT32 file system.
	The USB stick is defect.	Try another USB stick.
When the USB stick is inserted, the tester does not respond, until the USB stick is removed.	The USB stick is defect or not suited for use with the tester.	Try another USB stick.
After entering the diameters, the hardness value is “—”, thus invalid.	When using a digital eyepiece and the calibration factor for the used objective is not correct, the measurement of the diameter will be incorrect.	Contact Struers Service to check the calibration values of the objectives.
	When using a digital eyepiece and the eyepiece is not zeroed properly after powering on, the measurement of the diameter will be incorrect.	Restart the tester. Re-zero the eyepiece.
	The shape correction has a very small or zero diameter.	Check the diameter of the shape correction to see if it is zero or very small.
	The indent is not OK due to a dirty indenter.	Clean the indenter tip.
	The indent is not OK due to the roughness of the specimen surface.	Polish the specimen surface.
The tester does not respond when setting a limit value.	The specific limit is not set active.	Activate the limit function. See <a href="#">Setting Limits</a> .
Nothing happens when touching the touchscreen in areas where a button or touch sensitive area is displayed.	The touchscreen is not calibrated.	Calibrate the touchscreen.

## 5. Maintenance

### General Cleaning

- Keep Duramin-4 as clean as possible.  
To ensure a longer lifetime for your equipment Struers strongly recommends regular cleaning.

### Daily Maintenance Machine

- Clean all accessible surfaces with a soft, damp cloth.



**Important**

Do not use a dry cloth as the surfaces are not scratch resistant.  
Do not use aggressive or abrasive products.  
Grease and oil can be removed with ethanol or isopropanol.



**Important**

Never use acetone, benzol or similar solvents.

### Weekly Maintenance Cleaning Surfaces

- Clean painted surfaces and the control panel with a soft damp cloth and common household detergents.

### Weekly Inspection

- Inspect the following parts before every hardness test or at least weekly.

Part	Attention	Action	Precaution
<b>Indenter</b>	Tip dirty	Wipe indenter	Do not bend the indenter shaft
<b>Eyepiece or lens</b>	Lens surface polluted	Wipe lens	Do not scratch the Eyepiece / lens
<b>Anvil</b>	Rust	Remove rust	Do not bring the stage into contact with the turret.
<b>Test block</b>	Rusted	Replace test block	Do not use rusted test blocks

## Yearly Maintenance

- Clean the elevator spindle and oil lightly with e.g. a universal household oil (do NOT lubricate the spindle with motor oil).
  - Carefully lift the spindle cover.
  - Wipe the spindle THOROUGHLY after lubrication so that as little as possible oil is left on the spindle.
  - Wipe the spindle again after a few days to ensure no oil residue is left on the spindle surface.

## Testing Safety Devices

- Press Start .  
The machine starts operating
- Activate the Emergency-stop.  
If operation does not power down immediately, contact Struers Service.



### WARNING

Do NOT use the machine with defective Safety Devices.  
Contact Struers Service.

## Service

Struers recommends that a regular service check be carried out yearly or after every 1500 hours of use. Struers offers a range of comprehensive maintenance plans to suit the requirements of our customers. This range of services is called **ServiceGuard**. The maintenance plans include equipment inspection, replacement of wear parts, adjustments/calibration for optimal operation, and a final functional test.

## Replacing the Fuse

The fuse holder is located directly under the power connection on the rear of Duramin-4.

- Turn Duramin-4 off.
- Disconnect the power cable.
- Pull out the fuse holder using a flat-head screwdriver.

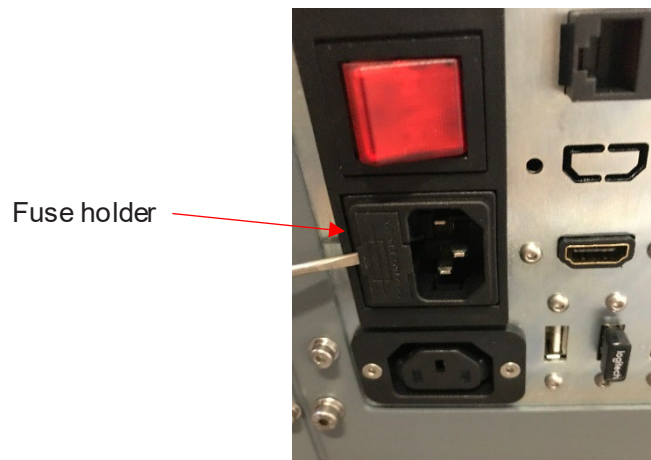

- Take out the blown fuse and replace with the reserve fuse.

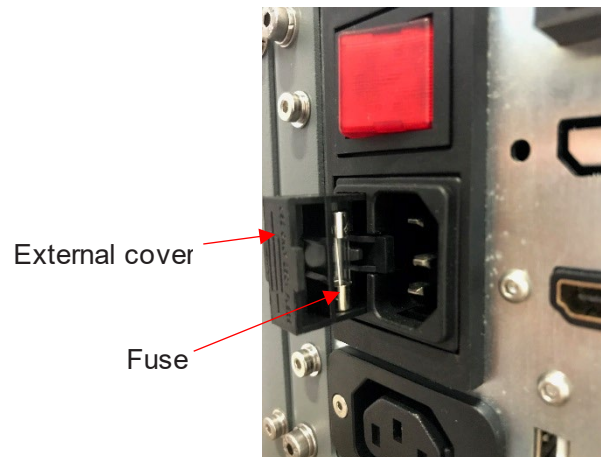

- Re-install the fuse holder.
- Re-connect the electric power cable.



**Tip**

Remember to order a new reserve.

## Calibration

Duramin-4's highly sensitive and accurate load cell and eyepiece are calibrated prior to shipping.

Please contact Struers Service should the load cell or eyepiece require recalibration.

## 6. Struers Knowledge

The need for fast, robust and well proven test methods for materials verification is inevitable. Vickers, Knoop, Rockwell and Brinell methods, with a countless number of loads and indenter geometries, gives an almost countless number of procedures, suitable for simple characterization of a large fraction of existing materials.



### **Information**

Visit the Struers Hardness testing website for a comprehensive introduction to the principles of hardness testing, useful troubleshooting tips and the latest application knowledge in the field.

Click on the link: [Struers - Ensuring Certainty / Knowledge / Hardness testing](#)

OR

Scan the QR code on the Duramin tag on your machine



## 7. Transport

The hardness testing machine must always be transported standing upright!

DO NOT ship or transport the tester without the correct packing materials.



**Store the packing crate, foam packaging and fittings for use whenever Duramin is transported/re-located.**

**Failure to use the original packaging and fittings could cause severe damage to the tester and will void the warranty.**

Turret – Position the foam block between the anvil/ stage and the turret.

DO NOT ship or transport the tester without mounting the lifting bar. This could cause severe damage to the testers load application system.



## 8. Technical Data



Please refer to the [\*Duramin 4 Technical Sheet\*](#) for further details.

		Duramin-4
<b>Hardness methods Duramin-4 M1</b>	Vickers	ISO 6507 ASTM E384, E92 JIS B 7725
	Knopp	ISO 4545 ASTM E92 JIS Z 2251
<b>Hardness methods Duramin-4 M2</b>	Vickers	ISO 6507 ASTM E384, E92 JIS B 7725
	Knopp	ISO 4545 ASTM E92 JIS Z 2251
	Brinell Duramin-40 M2 Only	ISO 6506 ASTM E10 JIS Z 2243
<b>Force range</b>	Duramin-4 M1	0,098 - 19,6N (10gf - 2 kgf)
	Duramin-4 M2	9,8 - 612,9 N (1 kgf - 62.5 kgf)
<b>Test force</b>	Force application	Multi-load cell, closed loop, force feedback system
	Test force tolerance	< 0.5 % for all test forces
	Dwell time settings	Default 10 seconds, user defined up to 999 seconds
<b>Turret</b>		Ultra-fast, 6 position turret, 2 intender position, 4 objective position
<b>Electrical data</b>	Power supply	100 V AC - 240 V AC, 50/60Hz, single phase
	Power consumption load	20 W
	Power consumption idle Power consumption Idle Power consumption idle	14 W
	Power consumption max. load Power consumption Max. load Power consumption max. load	26 W
<b>Dimensions</b>	Width	275 mm (10,8")
	Depth	474 mm (18,7")
	Height Duramin-4 M1	731 mm (28,8")
	Duramin-4 M2	811 mm (31,9")
<b>Weight</b>	Duramin-4 M1	90 kg
	Duramin-4 M2	107 kg
<b>Read method</b>		Analog eyepiece with 15x magnification

		Duramin-4
<b>Overview camera resolution</b>		NA
<b>Overview camera field of view</b>		NA
<b>Measurement camera resolution</b>		NA
<b>Positions in nosepiece</b>		6
<b>Position in nosepiece for overview camera</b>		NA
<b>Max no. of Indenters Max no. of indenters Max no. of Indenters</b>		2
<b>Max no. of Objectives No. of Objectives Max no. of objectives Max No. of Objectives</b>		4
<b>Indenter Shaft</b>	Diameter	3 mm (0,12")
<b>Z-Axis</b>		Manual
<b>Anti-colission protection</b>		Yes
<b>XY Stage / Anvil</b>		Duramin-4 M1: Manual Stage (Manual or Digital Stage Micrometers) Duramin-4 M2: Anvil
<b>Stage Size</b>		Duramin-4 M1: Manual stage: 100 x 100 mm (3.9 x 3.9") Duramin-4 M2: Anvil: 60 mm (2.4")
<b>Stage Stroke (travel range)</b>		25 x 25 mm (0,98 x 0,98")
<b>Auto Illumination</b>		NA
<b>Stage Illumination</b>		NA
<b>Laser/LED Guide</b>		NA
<b>Software</b>	Operating software	Internal firmware
	Integrated PC	Internal controller
	Monitor	NA (6,5" screen)
	Dual view	NA
	Possibility to connect Printer	Optional
	Ethernet Connection	Optional
	Data Export	TXT
<b>System</b>	Data output	1x USB A, LVDS
<b>Software modules</b>		Statistics (included)



**TECHNICAL DATA**

**Duramin-4**

		Duramin-4
<b>Sample height</b>	Duramin-4 M1	150 mm (5.9")
	Duramin-4 M2	
<b>Throat depth</b>		170 mm (6.7") (from Center of indenter to back)
<b>Safety standards</b>		CE labelled according to EU directives
<b>REACH</b>		For information about REACH. contact your local Struers office
<b>Operating environment</b>	Surrounding temperature	10 - 35 °C (50 - 95 °F)
	Humidity	10 % - 90 % RH non-condensing
<b>Safety Circuit Categories/Performance Level</b>	Emergency stop	EN ISO 13849-1 PL c, Category 1
		Stop category 0
<b>Noise level</b>	A-weighted sound emission pressure level at workstations	< 70 dB(A)
<b>Vibration level</b>	During operation	Total vibration exposure to upper parts of the body does not exceed 2.5 m/s <sup>2</sup>

# Declaration of Conformity

Manufacturer	Struers ApS • Pederstrupvej 84 • DK-2750 Ballerup • Denmark
Name	Duramin-4
Model	M1 or M2
Function	Hardness tester
Type	665
Cat. no.	06656101, 06656102
Serial no.	



Module H, according to global approach



We declare that the product mentioned is in conformity with the following legislation, directives and standards:

<b>2006/42/EC</b>	EN ISO 12100:2010, EN ISO 13850:2015, EN ISO 13849-1:2015, EN ISO 13849-2:2012, EN 60204-1:2018
<b>2011/65/EU</b>	EN 63000:2018
<b>2014/30/EU</b>	EN 61000-3-2:2014, EN 61000-3-3:2013, EN 55011:2016/A1:2017/A11:2020, EN 61326-1:2021

Authorized to compile technical file/  
Authorized signatory

Date: [Release date]



Pederstrupvej 84  
DK-2750 Ballerup  
Denmark