

Secotom-6

Instruction Manual



Manual No.: **16857027-06**

Revision **B**

Date of Release **2022.01.18**

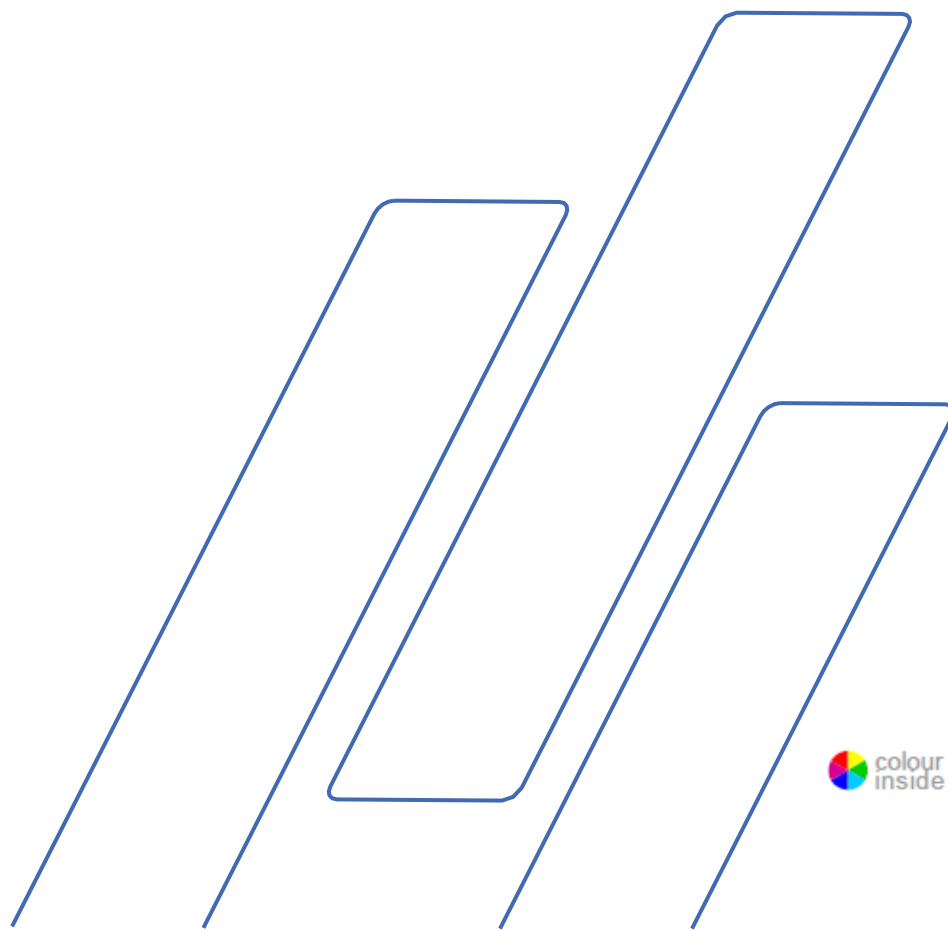

Table of Contents	Page
Intended use.....	4
Safety Precautions.....	6
Icons and Typography	8
User's Guide.....	10
Reference Guide.....	54
Secotom-6, Pre-Installation Checklist	78
Declaration of Conformity	87

Intended use

For professional, automatic materialographic cutting of materials for further materialographic inspection. The machine is only to be operated by skilled/trained personnel. The machine is only designed to be used with Struers consumables specially designed for this purpose and this type of machine.

The machine is for use in a professional working environment (e.g. a materialographic laboratory).

Do not use the machine for:

Cutting of materials other than solid materials, suitable for materialographic studies. In particular, the machine must not be used for any type of explosive and/or flammable material, or materials which are not stable during machining, heating or pressure.

The machine may not be used with cut-off wheels which are not compatible with the machine requirements (e.g. toothed cut-off wheels).

Model:

Secotom-6



NOTE:

READ the instruction manual carefully before use.
Keep a copy of the manual in an easy-to-access place for future reference.

Secotom-6
Instruction Manual

Always state *Serial No* and *Voltage/frequency* if you have technical questions or when ordering spare parts. You will find the *Serial No.* and *Voltage* on the type plate of the machine itself. We may also need the *Date* and *Article No* of the manual. This information is found on the front cover.

The following restrictions should be observed, as violation of the restrictions may cause cancellation of Struers legal obligations:

Instruction Manuals: Struers Instruction Manual may only be used in connection with Struers equipment covered by the Instruction Manual.

Struers assumes no responsibility for errors in the manual text/illustrations. The information in this manual is subject to changes without notice. The manual may mention accessories or parts not included in the present version of the equipment.

The contents of this manual are the property of Struers. Reproduction of any part of this manual without the written permission of Struers is not allowed.

All rights reserved. © Struers 2019.

Struers
Pederstrupvej 84
DK 2750 Ballerup Denmark
Telephone +45 44 600 800
Fax +45 44 600 801

Secotom-6 Safety Precautions¹



Read carefully before use

1. Ignoring this information and mishandling of the equipment can lead to severe bodily injuries and material damage.
2. The machine must be installed in compliance with local safety regulations. All functions on the machine and any connected equipment must be in working order.
3. The operator(s) must read the Safety and User's Guide sections of this manual and the relevant sections of the manual for any connected equipment and accessories. The operator(s) must read the Instructions for Use and, where applicable, Safety Data Sheets for the applied consumables.
4. This machine is to be operated and maintained by skilled/trained personnel only.
5. Use only intact cut-off wheels. Cut-off wheels must be approved for min. 5,000 rpm.
6. The machine must be placed on a safe and stable table with an adequate working height able to carry the machine and supplementary accessories and consumables.
7. Operators should ensure that the actual voltage corresponds to the voltage on the rear of the machine. The machine must be earthed. Follow the local regulations. Always turn the power off and remove the plug or the cable before dismantling the machine or installing additional components.
8. Consumables: only use consumables specifically developed for use with this type of materialographic machine.

10. Mind the protruding safety catch when the guard is raised. The workpiece must be securely clamped in a clamping device. Use of working gloves is recommended as specimens may be both very hot and have sharp edges.

¹

From Safety Precaution sheet, Revision B

*Secotom-6
Instruction Manual*

- 13.** Use of safety goggles is recommended when using the flushing hose. Only use the flushing hose for cleaning inside the cutting chamber.
- 14.** If you observe malfunctions or hear unusual noises - stop the machine and call technical service.
- 15.** The machine must be disconnected from the mains prior to any service. Wait 15 minutes until residual potential on the capacitors is discharged.
- 16.** Do not cycle mains power more than once every three minutes. Damage to the drive will result.
- 17.** In case of fire, cut the power alert bystanders and the fire brigade. Use a powder fire extinguisher. Do not use water.

The equipment should only be used for its intended use and as detailed in the Instruction Manual.

The equipment is designed for use with consumables supplied by Struers. If subjected to misuse, improper installation, alteration, neglect, accident or improper repair, Struers will accept no responsibility for damage(s) to the user or the equipment.

Dismantling of any part of the equipment, during service or repair, should always be performed by a qualified technician (electromechanical, electronic, mechanical, pneumatic, etc.).

Icons and Typography

Struers uses the following icons and typographical conventions. A list of the Safety Messages used in this manual can be found in the chapter on [Cautionary Statements](#)

Always consult the Instruction Manual for information on the potential hazards marked by the icons fixed to the machine.

Icons and Safety Messages



ELECTRICAL HAZARD

indicates an electrical hazard which, if not avoided, will result in death or serious injury.



DANGER

indicates a hazard with a high level of risk which, if not avoided, will result in death or serious injury.



WARNING

indicates a hazard with a medium level of risk which, if not avoided, could result in death or serious injury.



CAUTION

indicates a hazard with a low level of risk which, if not avoided, could result in minor or moderate injury.



CRUSHING HAZARD

indicates a crushing hazard which, if not avoided, could result in minor, moderate or serious injury.



EMERGENCY STOP

General Messages

**NOTE:**

indicates a risk of damage to property, or the need to proceed with special care.

**HINT:**

indicates additional information and tips.

Colour Inside Logo



The 'colour inside' logo on the cover page of this Instruction Manual indicates that it contains colours which are considered to be useful for the correct understanding of its contents.

Users should therefore print this document using a colour printer

Typographic conventions

Bold type	indicates button labels or menu options in software programs
<i>Italic type</i>	indicates product names, items in software programs or figure titles
Blue text	indicates a link to another section or webpage
■ Bullets	indicates a necessary work step

User's Guide

Table of Contents	Page
1. Getting Started	12
Device Description	12
Checking the Contents of the Packing Box	13
Unpacking Secotom.....	13
Placing Secotom.....	14
Recommended workbench dimensions	14
Getting Acquainted with Secotom	15
Front of Secotom.....	16
Rear of Secotom	16
Inside the Chamber	17
Safety Lock.....	18
Supplying Power.....	19
Single-phase Supply	19
2-phase Supply	19
Connection to the machine	19
Filling the Recirculation Tank with Cooling Fluid	20
Optimising Cooling.....	21
Mounting the Cut-off Wheel	21
Cutting Table	23
Positioning the Cutting Table	24
Attaching Clamping Tools.....	24
Quick-clamping and Spring Clamp Devices.....	24
Flushing Hose.....	25
Debris Collection.....	26
Connection to an External Exhaust System	26
Noise	26
Handling noise.....	26
2. Basic Operation.....	27
Front Panel	27
Reading the Display.....	28
Manoeuvring in the Menu Structure.....	29
Acoustic Signals	29
Standby Mode	29
Software Settings.....	29
Zero Position	30
Changing the Language.....	31
Editing Numeric Values	32
Editing Alphanumeric Value.....	33

*Secotom-6
Instruction Manual*

Main menu.....	34
Positioning.....	34
Cutting Method Parameters.....	34
Editing the Cutting method:.....	35
Return position	36
Maintenance Menu	36
Configuration Menu	37
Starting the Cutting Process	38

3. Maintenance39

General Cleaning.....	39
Daily Inspection	39
Checking the Guard	39
Checking the Safety Lock.....	39
Daily Maintenance	40
Weekly.....	41
Cleaning the Cutting Chamber	41
Checking the Cooling Fluid Tank.....	42
Tube for Water-free Cooling Fluid	42
Monthly.....	43
Cleaning the Cooling Fluid Tank.....	43
Yearly	44
Inspection of Guard	44
Replacing the Guard	44
Testing Safety Devices	44
Emergency stop	44
Safety lock.....	45
Hold-to-run Button	45
Spare Parts.....	45
Maintenance of Clamping Devices.....	46
Maintenance of Cutting Tables	46
Turning or Replacing Steel Bands on the Cutting Table	46
Maintenance of Cut-off Wheels.....	46
Storing of Abrasive Cut-off Wheels.....	46
Maintenance of Diamond and CBN Cut-off Wheels	46
Dressing Diamond and CBN Cut - off Wheels	47
Testing Cut-off Wheels.....	47
Changing Cooling Pump Tubes	48

4. Cautionary Statements50

5. Transport and Storage52

6. Disposal.....53

1. Getting Started

Device Description

Secotom-6 is an automatic cut-off machine for cutting the majority of solid and stable (non-explosive) materials. It has a motorized Y-table unit and recirculation cooling tank. The Y- table unit can only be moved when the guard is closed.

The operator starts the process by selecting and mounting the cut-off wheel and then entering the cutting parameters (e.g. cut-off wheel rotation speed and cutting length) into the machine.

The workpiece is secured by using clamping tools – either directly to the cutting table or to a stand which is clamped on the cutting table.

The guard locks when the operator starts the machine. It remains locked until all movement is stopped, and the cutting table is in the selected stop position.

The specimens may be hot after the process and it is therefore recommended to wear gloves when handling the processed specimens.

The recirculated cooling fluid contains additives and debris from the cutting process. It is recommended to wear goggles and gloves when handling the cooling fluid.

It is recommended to connect Secotom-6 to an external exhaust system to remove fumes from the cutting process.

In case of power-loss during the process, the guard remains locked. Use the special key to release the lock and open the guard.

The emergency stop cuts the power to all moving parts. The guard can be opened when the emergency stop is released.

*Secotom-6
Instruction Manual*

**Checking
the Contents
of the Packing Box**

The packing box contains the following parts:

1	Secotom-6
2	Mains cables
1	Triangle key for safety lock release
1	Support pin
1	Socket spanner 17 mm
1	Hose for connection to exhaust, 51 mm dia., 1.5 m
1	Hose clamp, 40-60 mm dia.
1	Instruction Manual Set

Unpacking Secotom



NOTE:

Always lift Secotom from underneath the machine.

A crane and two lifting straps² are required to lift Secotom off the shipment pallet.

Before lifting Secotom into position:

- Remove the screws around the base of the packing crate and lift the entire upper part of the crate.
- Remove the metal brackets securing Secotom to the pallet (a 4 mm Allen key is required to remove the 8 screws that secure the metal brackets).
- Remove the recirculation tank.
- Place the two lifting straps under Secotom.
- Position the straps under Secotom, so that they are on the inside of the feet. See drawing.

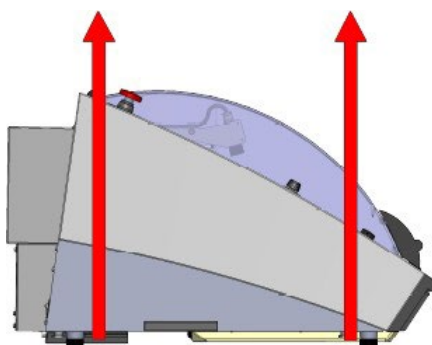

- Use straps which are long enough so that they do not place stress on the guard (use straps of approx. 3-3½ m in length).
- A lifting bar is recommended so that the two straps are kept apart below the lifting point.
- Lift Secotom onto the table.
- Lift the front of Secotom and carefully move into place.

2

Crane and straps must be approved for at least twice the weight of the load.



CRUSHING HAZARD

Take care of your fingers when handling the machine. Wear safety shoes when handling heavy machinery.



HINT:

Store the packing crate, bolts and brackets for use whenever Secotom is transported/re-located.

Failure to use the original packaging and fittings could cause severe damage to the machine and will void the warranty.

Placing Secotom

- The machine must be placed on a safe and stable table with an adequate working height and which is able to carry the machine and supplementary accessories and consumables.
- Ensure that the work station has adequate lighting. Avoid direct glare (dazzling light sources within the operator's line of vision) and reflected glare (reflections of light sources).

Recommended workbench dimensions

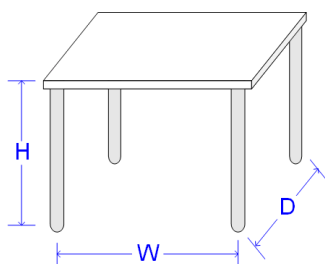

Height: Recommended 80 cm / 31.5"
Width: min. 70 cm / 27.6"
Depth: min. 80 cm / 31.5"

- Check that the Secotom is resting securely with all 4 rubber feet on the table.
- (For greatest accuracy, the machine must be completely level - tolerance ± 1 mm).
- The machine must be close to the power supply.
- The machine must be operated in a well-ventilated room or connected to an exhaust system.

Recommended Space

To facilitate easy access for servicing, allow sufficient space around the machine.

Getting Acquainted with Secotom

Please familiarise yourself with the location and names of all the Secotom components:

MAIN SWITCH

The main switch is located at the rear of Machine.



EMERGENCY STOP

The Emergency Stop is located on the front of the machine.

Push the red button to Activate.

Turn the red button clockwise to Release.



NOTE:

Do not use the Emergency stop for operational stop of the machine during normal operation.

BEFORE releasing (disengaging) the Emergency stop, investigate the reason for activating the Emergency stop and take any necessary corrective action.

*Secotom-6
Instruction Manual*

Front of Secotom

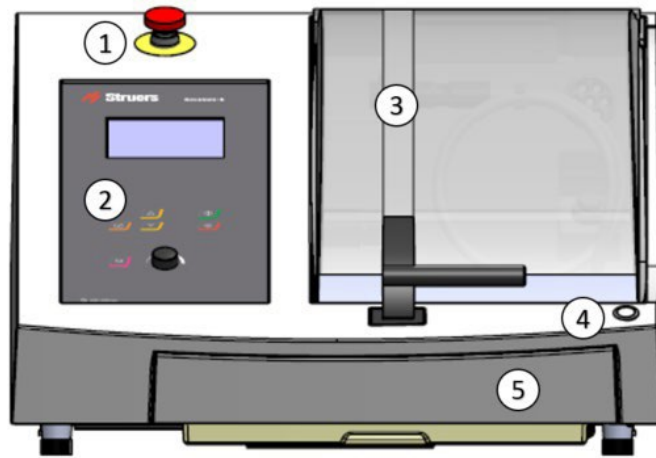

①	Emergency Stop	④	Hold-to-run button
②	Front Panel (details in section 2. Basic Operation)	⑤	Cooling fluid tank
③	Guard		

Rear of Secotom

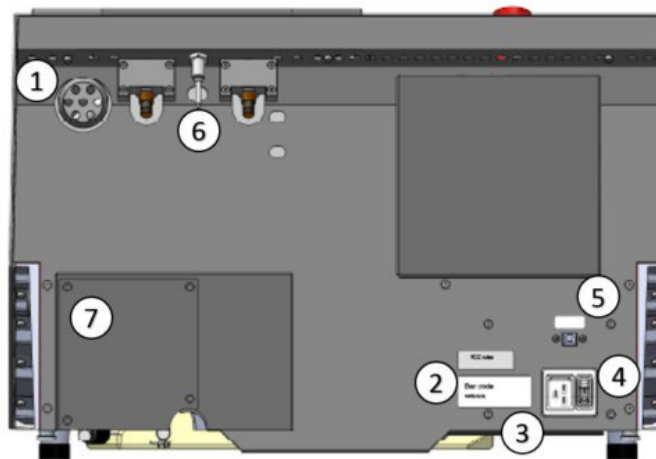

①	Flange for Exhaust	⑤	Service socket
②	Type Plate	⑥	Hinges
③	Mains connection	⑦	Pump cover
④	Main switch		

Secotom-6
Instruction Manual

Inside the Chamber

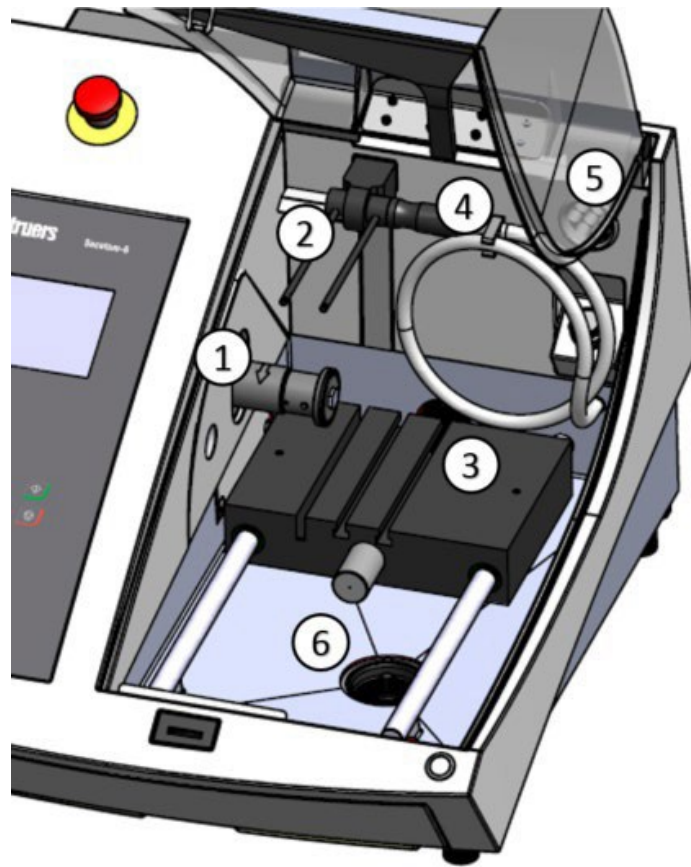

①	Cut-off wheel spindle	④	Flushing Hose
②	Cooling nozzles	⑤	Exhaust
③	Cutting table	⑥	Drain

Safety Lock



NOTE:

The guard on Secotom can only be opened when the machine is connected to a power supply and the main power switch is on.

To open the guard if the power is not connected:

- Remove the Cooling fluid tank.

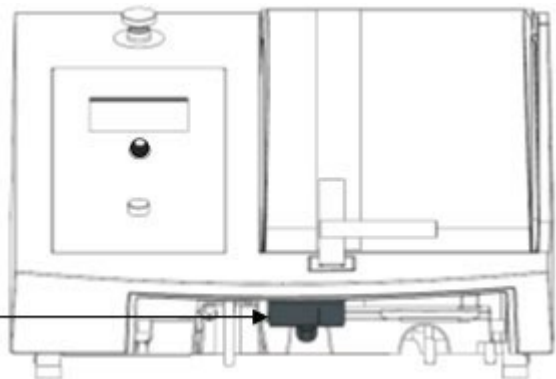

- Use the triangle key (supplied) to de-activate the safety lock. Turn the key 180°.

Do not use force!



HINT:

Remember to re-activate the safety lock release before operating Secotom.

Supplying Power



ELECTRICAL HAZARD

Switch the power off when installing electrical equipment. The machine must be earthed (grounded). Check that the mains voltage corresponds to the voltage stated on the type plate on the side of the machine. Incorrect voltage may result in damage to the electrical circuit.

The Secotom is shipped with 2 types of Mains cables:

Single-phase Supply

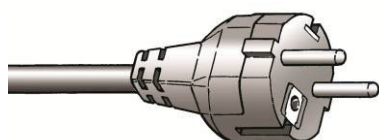

The 2-pin (European Schuko) plug is for use on single-phase, 200-240 V connections.

If the plug supplied on this cable is not approved in your country, then the plug must be replaced with an approved plug. The leads must be connected as follows:

Yellow/green:	earth (ground)
Brown:	line (live)
Blue:	neutral

2-phase Supply



The 3-pin (North American NEMA) plug is for use on 2-phase, 200-240 V power connections.

If the plug supplied on this cable is not approved in your country, then the plug must be replaced with an approved plug. The leads must be connected as follows:

Green:	earth (ground)
Black:	line (live)
White:	line (live)

Connection to the machine

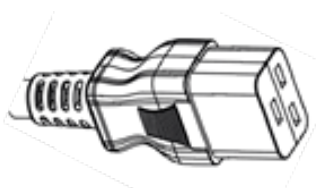

- Connect the power cable to the Secotom. (IEC 320 C19 connector).
- Connect to the mains power supply.

Filling the Recirculation Tank with Cooling Fluid

The Secotom has a built-in recirculation cooling fluid system. The fluid coming from the nozzles passes over the cut-off wheel and collects in the drain in the cutting chamber; where it then returns to the tank, which is located under the cutting chamber.



CAUTION

Read the Safety Data Sheet for the additive for cooling fluid before use.

Avoid skin contact with the additive for cooling fluid. Use of gloves and safety goggles are recommended.

- With the tank in position under the chamber.

Fill the tank by slowly pouring a **4%** solution of Struers additive, Cooli Additive:

190ml Cooli Additive and 4.5 l water

through the hole in the base of the chamber.



NOTE:

Take care not to overfill the tank!



HINT:

It is very important that the **concentration** of the Cooli Additive in the cooling fluid is **between 3 % and 6%**.

Check the concentration of Cooli Additive with a refractometer.

Cooli Additive concentration = 2.4 x °Brix value.

Water Sensitive Materials

Struers Water-free Cutting Fluid is available for cutting water sensitive materials.



NOTE:

The tube in the cooling fluid pump **MUST** be replaced by a special tube when using Water-free Cutting Fluid. The standard tube will only last for a few hours, as it will be affected by the Water-free Cutting Fluid.

Tubes for Water-free Cutting are available as an accessory (Cat.no.: 05996921).

For instructions on exchanging the tube, please see the section on [Changing Cooling Pump Tubes](#) in the **Maintenance** section of the Instruction Manual.

Optimising Cooling

Sufficient cooling is very important for ensuring the best cutting quality and to avoid burning of the workpiece and damaging the cut-off wheel. Optimise the cooling effect using the following tips:

- Always use additive to protect the cutting machine from corrosion and to improve cutting and cooling qualities.
- Ensure that there is sufficient fluid in the tank for optimal cooling.
- Maintain the correct concentration of additive in the cooling fluid (percentage stated on the container of the Struers Additive, Cooli Additive).
- Remember to add Struers Additive each time you refill with water. See hint on page [20](#).
- It is recommended to change the cooling fluid at least once a month to prevent the growth of microorganisms.
- Only use Struers' own additives.
- **Do not** use oil, petrol, or turpentine-based additives, as they can affect the cooling fluid tubes.

Mounting the Cut-off Wheel

- Lift the guard to the "open" position (the position where it will stay up and open when released).



CAUTION

Mind the protruding safety catch when the guard is raised.

- Lift the cooling fluid nozzles to gain access to the cut-off wheel mounting.

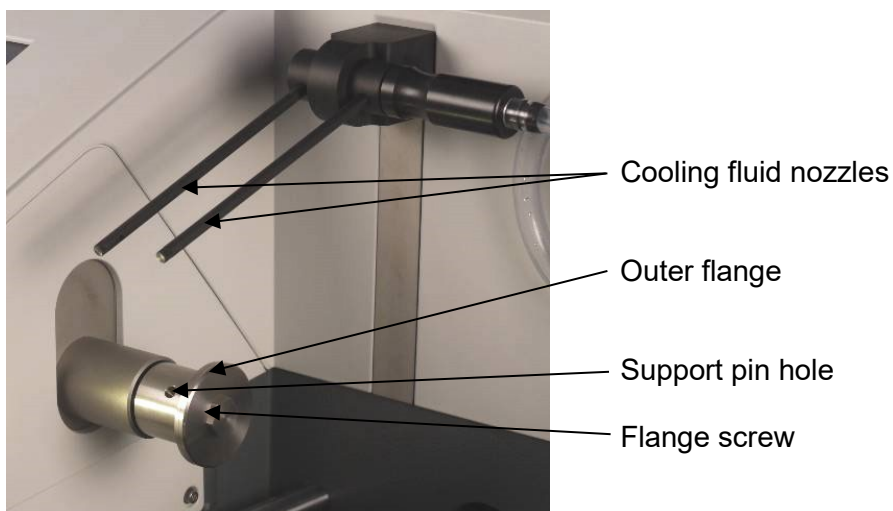

- Insert the support pin into the hole on the cut-off wheel spindle. Use the socket spanner 17 mm to loosen the flange screw.

Secotom-6
Instruction Manual



- Remove the outer flange.



NOTE:

The tolerance between the spindle and inner flange is very small which means that the two surfaces must be absolutely clean.

Never try to squeeze the cut-off wheel on as this may damage the spindle or the cut-off wheel. If there are any small burrs, remove them with grinding paper grit size 1200.

NOTE:

When mounting cut-off wheels with a 12.7 mm centre hole, make sure that the 22 mm arbor insert has been removed. Failure to do this will result in the cut-off wheel being pressed out of shape.

- Before mounting the cut-off wheel, test it for damages. See [Testing Cut-off Wheels](#) on page 47.
- Mount the cut-off wheel (using the 22 mm insert if necessary) and remount the outer flange, with the machined face towards the inner flange.
- Insert the support pin in the hole in the inner flange.

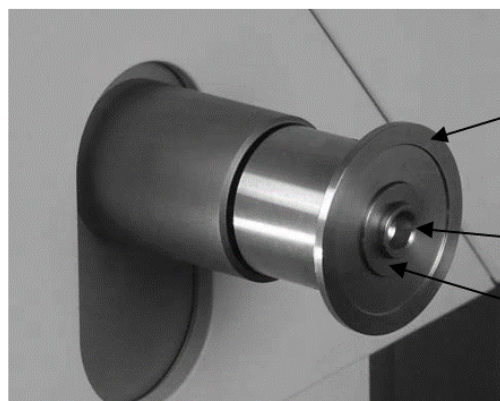

- Gently fasten the flange screw using the socket spanner 17 mm. (The screw should be tightened with a force of maximum 5 Nm / 4 lbf-ft).

- Lower the cooling fluid nozzles to their operating positions.



Cutting Table

The Secotom is fitted with a moving cutting table.

1 mm thick cut-off wheels are positioned in the middle of the Y-table cutting groove.

Thicker cut-off wheels will be positioned slightly to the right. Thinner cut-off wheels will be positioned slightly to the left. Movement of the table is controlled using the keys on the Front Panel and through the software, which is described in [Basic Operation](#).

The table has 8 mm T-slots, which are used to secure clamping tools. Although these clamping tools are available as accessories, details about the table and the clamping tools are described in this and the following sections.

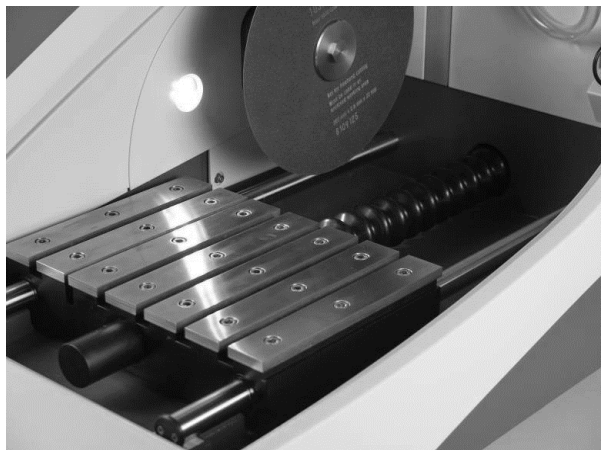

Positioning the Cutting Table

The cutting table must be manually positioned before starting the process.

- Close the guard.
- Use the keys on the Front Panel to move the cutting table.

Attaching Clamping Tools (accessories)

There are several types of clamping tools available as accessories (please refer to the [Secotom brochure](#) for details of the range available).

Some of these are mounted directly on the cutting table while others with more sophisticated features, need to be fixed on a stand using a dovetail holder.



NOTE:

When fitting clamping tools, always ensure that they do not block the cut-off wheel. Failure to do this will result in damage to the clamping tools and/or cut-off wheel.



CAUTION

Mind the protruding safety catch when the guard is raised.

Quick-clamping and Spring Clamp Devices

- Position the back stop and the clamping device as shown in the illustration.



- Tighten the nuts to secure.

Flushing Hose

The Secotom comes complete with a flushing system. This enables the cutting chamber to be rinsed clean of any debris discarded during the cutting process. Flushing is operated through the Front Panel button and hold-to-run button.



CAUTION

Avoid skin contact with the additive for cooling fluid. Always wear gloves and goggles.

Do not start flushing before the flushing hose is pointing into the cutting chamber.

- Remove the hose from the cooling fluid nozzles.
- Press FLUSH  on the Front Panel.
- Point the hose into the cutting chamber
- Hold hold-to-run button to start flushing

To stop flushing, release hold-to-run button

To start flushing again repeat the steps.

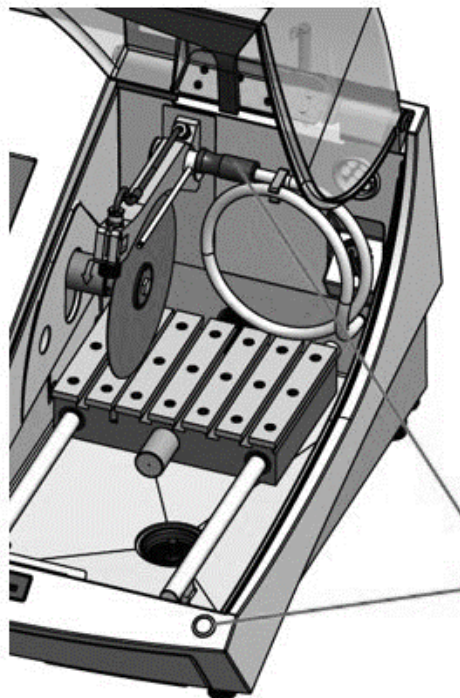

Flushing
hose

Hold-to-run button



NOTE:

Remember to replace the hose in its holder when you have finished flushing the cutting chamber.

Debris Collection

Secotom has two systems to keep the debris from polluting the cutting fluid and blocking the nozzles. The first is a basket in the drain that prevents larger pieces from entering the tank. The second is a magnet in the tank that collects magnetic particles.



NOTE:

Check the basket and the magnet for cutting debris before starting the cutting process; a blocked drain can result in water overflow and insufficient cooling as the level of fluid in the tank is too low.

Connection to an External Exhaust System

Struers recommends the use of an exhaust system as workpieces may emit harmful gases when cut.

The machine is prepared for connection to an exhaust system via a 50 mm ventilation flange at the rear of the cabinet.

- Mount an exhaust hose from your local exhaust system onto the ventilation flange.

Noise

See [Technical Data](#) in the rear of the Instruction Manual for information on the sound pressure level value.

Handling noise (during operation)

Different materials have different noise characteristics. Decreasing the rotational speed and/or the force with which the workpiece is pressed against the cut-off wheel, will lower the noise. Processing time may increase.



CAUTION

Prolonged exposure to loud noises may cause permanent damage of hearing.
Use hearing protection if exposure to noise exceeds levels set by local regulations.

2. Basic Operation

Front Panel

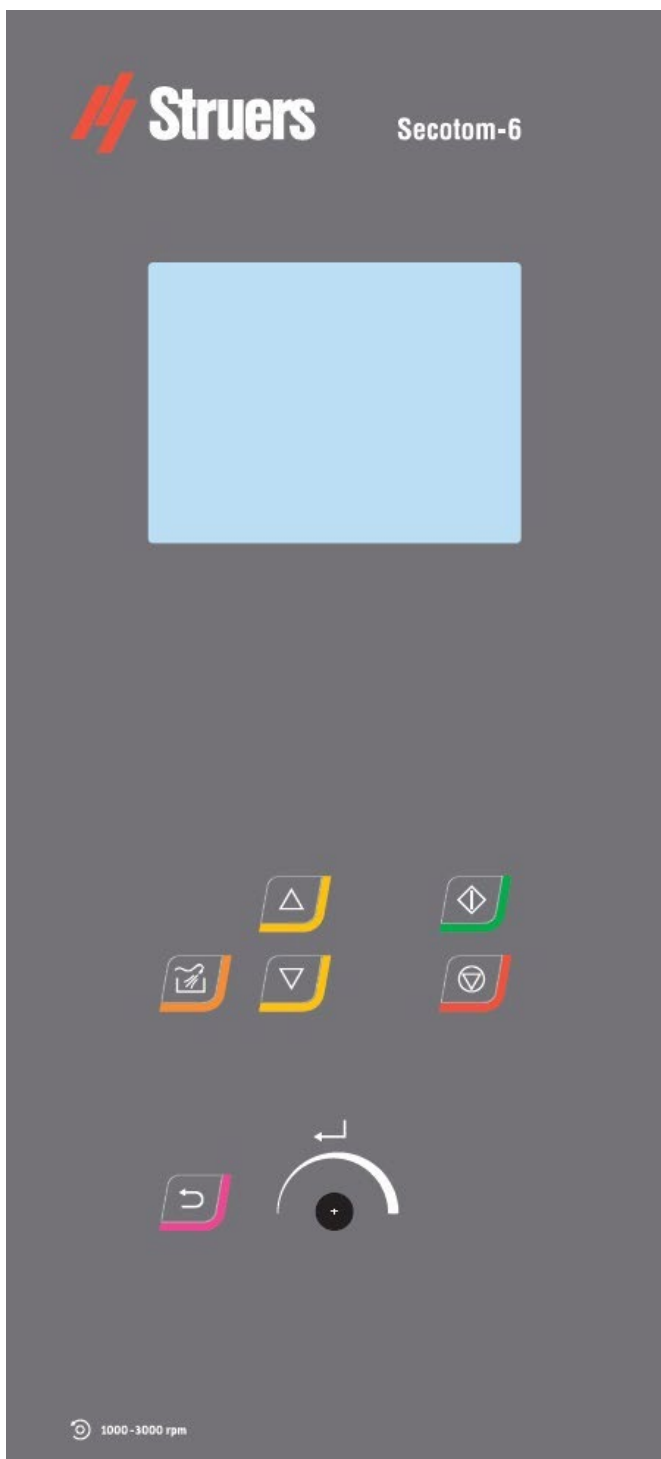

Key

Function

Turn
/
Push
knob



Multifunction knob.
Turn knob to move
the cursor or to
adjust settings.
Push knob to select
(ENTER)

START



Starts the cutting
process.

STOP



Stops the cutting
process.

ESC



Leaves the present
menu or aborts
functions/changes.

FLUSH



Starts the FLUSH
operation.



Moves the Cutting
table forwards
(in the Y-direction)
in steps of 100 μm .



Moves the cutting
table backwards
(in the Y-direction)
In steps of 100 μm .

Reading the Display

The display on the Front Panel provides different levels of status information. For example, when the machine is switched on, the display informs you about the physical configuration of the Secotom and the version of software that is installed:

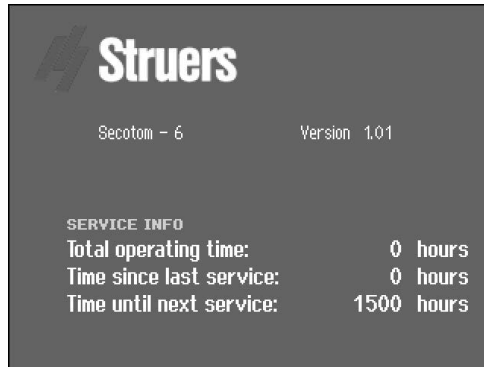

When operating the Secotom, this display is the user-interface to Secotom software.

The display is primarily divided into 2 areas. The position of these areas and the information they contain are explained in the illustration below, which uses the *Cutting method* as an example:

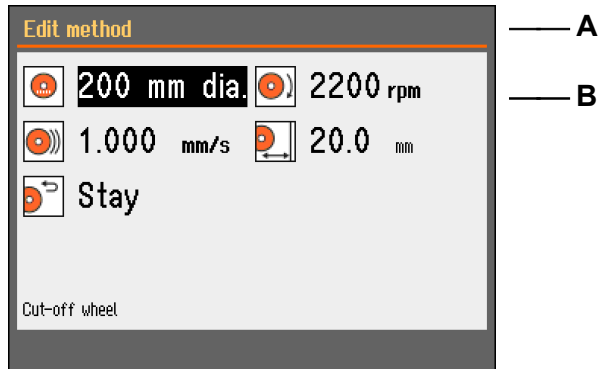



- A** Heading: this is a navigational aid, telling you where you are in the software's hierarchy.
- B** Information fields: these will be either numerical values or text fields, providing information associated with the process shown in the heading. The inverted text shows the cursor position.

Secotom-6 Instruction Manual

Manoeuvring in the Menu Structure

To select items in the menu:

-  Turn knob to select a menu, method group or a parameter.
-  Push knob to open or activate the selection.
- Esc** Press **Esc** to return to the Main menu.

Acoustic Signals

When pressing a key, a short beep indicates that the command has been accepted, whereas a long beep indicates that the key cannot be activated now.

The 'short' beep can be switched on or off in the *Configuration menu*.

Standby Mode



To increase the lifetime of the display, the backlight is dimmed automatically if Secotom has not been used for 10 min.

- Press any key to re-activate the backlight.

Software Settings



When switching Secotom on for the first time, the *Select language* screen will appear (to change the language after this, refer to [Changing the Language](#)).



-  Turn knob to select the language you prefer.
-  Push knob to accept the language.

You will now be prompted to set the date.







-  Turn knob to select and to adjust the settings.
-  Push knob to accept the settings.

Secotom-6 Instruction Manual

You will now be prompted to set the time.



-  Turn knob to select and to adjust the settings.
-  Push knob to accept the settings.
-  When Date and Time have been set, turn knob to select *Save and Exit*.
-  Push knob to save the settings and return to the *Main menu*.

The *Main menu* now appears in the language you have chosen.

During normal operation, immediately after start-up, where the splash screen is displayed, the software goes to the screen that was used before the machine was switched off. Thus, you can continue exactly where you left last time the machine was used.

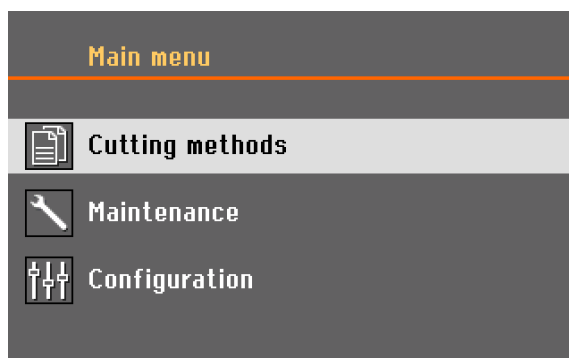

To go to the *Main menu*, use the **Esc** key. The *Main Menu* is the highest level in the menu structure. From this menu, you can enter all the other menus.





Zero Position

Zero position is calibrated after each 10th start-up, **or** if reference positions have been lost.

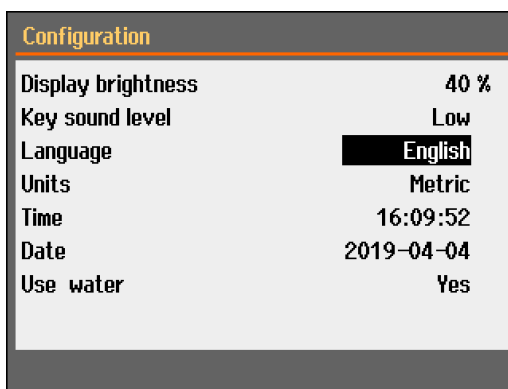

Changing the Language

-  Turn the knob to select *Configuration*.
-  Push knob to activate the *Configuration Menu*.
-  Turn knob to select *Language*.



-  Push knob to activate the *Select language* pop-up menu.



-  Turn knob to select the language you prefer.
-  Push knob to accept the language.

The *Configuration* menu now appears in the language you have chosen.

Check if there are any other settings that need changing in the *Configuration* menu. If not, Push **ESC** to return to the main menu.

Otherwise use the Turn/Push knob to select and change the required parameters.

Secotom-6
Instruction Manual

Editing Numeric Values



Turn knob to select the value to be changed, e.g. *Wheel speed*:



Push knob to edit the value.

A scroll box appears around the value.

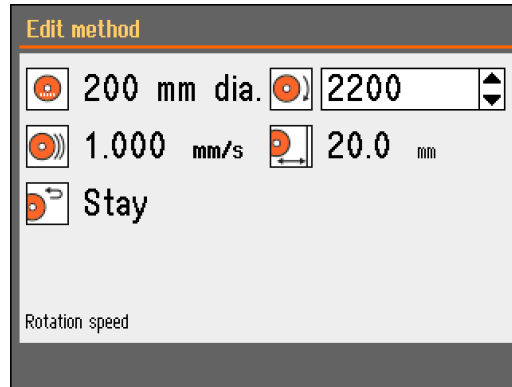

Turn knob to increase or decrease the numeric value.

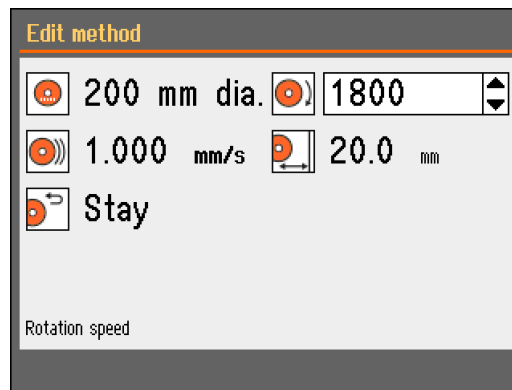

Push knob to accept the new value.
(Pressing **Esc** aborts the changes, preserving the original value.)

Editing Alphanumeric Value



Turn knob to select the alphanumeric value to be changed,

e.g. *Return position*



Push knob to edit the value.

A pop-up menu appears.

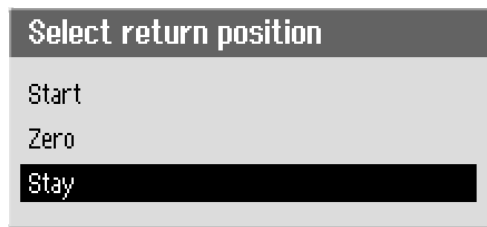

Turn knob to select the correct choice.



Push knob to accept the new selection and to continue or to return to the previous screen.

(Pressing Esc aborts the changes, preserving the original setting.)



NOTE:

If there are only 2 options, the popup box is not displayed. Pushing the knob (Enter) will toggle between the 2 options.

Main menu

The *Main menu* is the highest level in the menu structure. From this menu, you can enter the *Cutting methods*, *Maintenance* and *Configuration* menus.

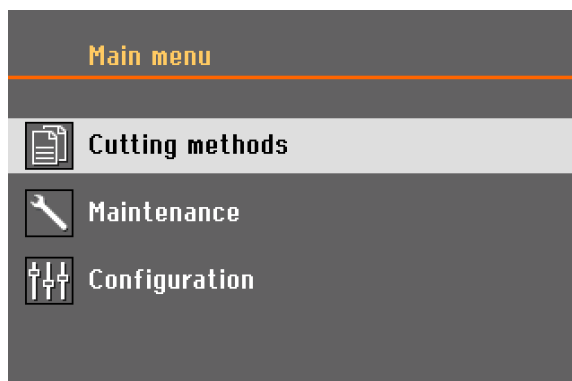

Positioning

Press and hold the "Run" button and the positioning key to display the "Positioning" menu.

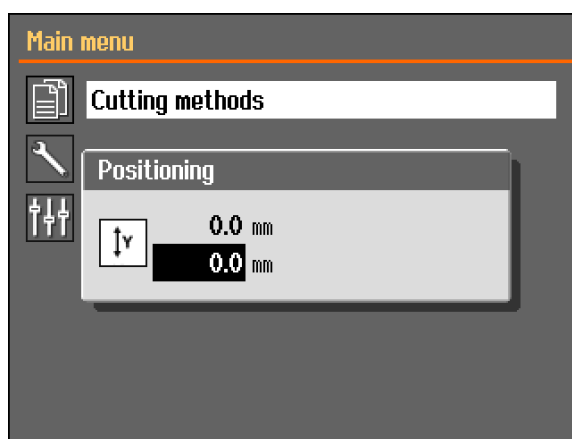

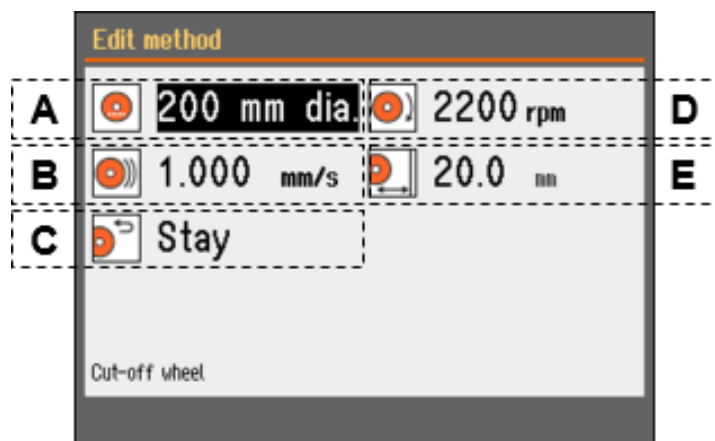

Cutting Method Parameters



A	Cut-off wheel	D	Rotation speed
B	Feed speed	E	Cut Length
C	Return position		

Editing the Cutting method:

 Turn knob to select the cutting method to be edited.

 Push knob to edit the method.



 Turn knob to select the *Cut-off wheel*.

 Push knob to select a cut-off wheel from the menu.

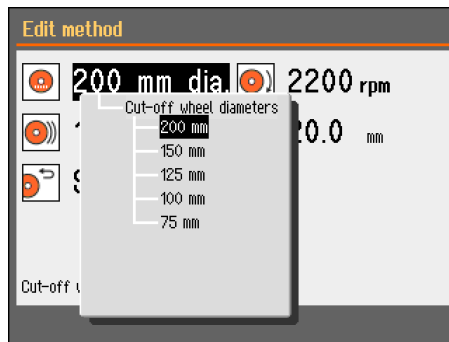

Changes made to the cutting method will automatically be saved. To re-set to default values, see the section on the [Maintenance Menu](#)

Return position

There are 3 options for the position the cut-off wheel will return to after the cutting process is complete:



Start position:	Cutting table returns to the start position.
Zero position:	Cutting table returns to zero position.
Stay:	Cutting table does not move after cutting.

Maintenance Menu

The Maintenance menu has four sub menus.

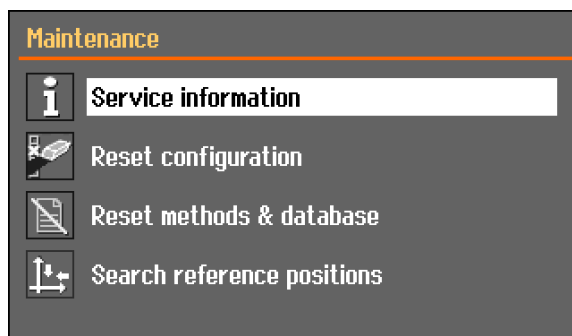

Service information	Information regarding the equipment, mainly to be used in connection with service.
Reset configuration:	Resets all parameters in the <i>Configuration menu</i> to default values.
Reset methods & database	Resets all methods and the database to default values.
Search reference positions	Reference position (Zero position) is calibrated after each 5 th start-up, or if reference positions have been lost. If reference positions have been lost, they can be reset manually.

Configuration Menu

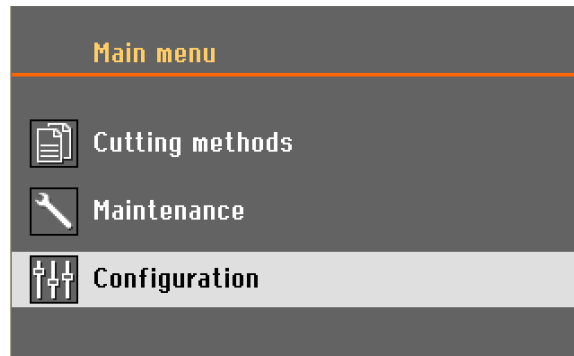

The *Configuration* menu contains the parameters which apply to all methods.

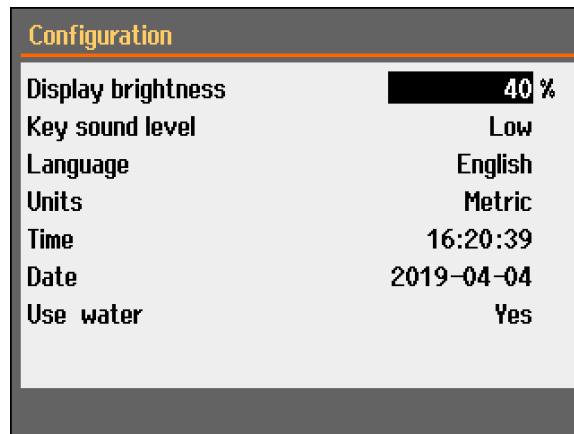

Starting the Cutting Process

- Secure the workpiece on the cutting table.
- Ensure that the cooling fluid nozzles are lowered into position.
- Close the guard
- Position the cutting table in the correct place.



NOTE:

The guard cannot be lifted whilst cutting is in progress.

- Select a Cutting method
 - Set/check the correct values.
 - Start the cutting process by pressing START .
- If required, Feed speed, Rotation speed and Cutting length can be changed during the cutting process.



NOTE:

Check that there is a steady flow of cooling fluid from the nozzles.

Stopping the Cutting Process

When the specified cut length is reached, the cut-off wheel will automatically stop rotating and the cutting table will return to the selected stop position.



HINT:

The cutting process can be stopped at any time by pressing STOP  on the Front Panel.

If the machine has been stopped with STOP , the cutting table will stay in position.

3. Maintenance

Proper maintenance is required to achieve the maximum uptime and operating lifetime of the machine. Maintenance is also important in ensuring your machine's continued safe operation. The maintenance procedures described in this section must be carried out by skilled or instructed persons.

General Cleaning

To ensure a longer lifetime for your Secotom Struers strongly recommends daily cleaning of the cutting chamber. Clean the cutting chamber thoroughly if the Secotom is not to be used for a longer period of time.

Daily Inspection

Secotom must be checked before use. Do not use the machine until any damage is repaired.

Checking the Guard

- Visually inspect the guard for signs of wear or damage (e.g. dents, cracks, damage to edge sealing).

Please refer to the section on [Replacing the Guard](#) if the guard is damaged.



WARNING

The guard should be **replaced immediately** if it has been weakened by collision with projectile objects or if there are visible signs of deterioration or damage.

Checking the Safety Lock

It is very important that the interlock tongue is checked regularly for damage and perfect fitting.

- Check the interlock tongue for correct function. It must slide unobstructed into the locking mechanism.

Daily Maintenance

- Clean all accessible surfaces with a soft, damp cloth.



NOTE:

Do not use a dry cloth as the surfaces are not scratch resistant. Grease and oil can be removed with ethanol or isopropanol.

NOTE:

Never use acetone, benzol or similar solvents.

- Clean the cutting chamber, especially the T-slot cutting table.



CAUTION

Read the Safety Data Sheet for the additive for cooling fluid before use.

Avoid skin contact with the additive for cooling fluid.

Use of gloves and safety goggles are recommended. Cooling fluid may contain swarf (cutting /grinding debris or other particles).

Do not start flushing until the flushing hose is pointing into the cutting chamber.

- If necessary, clean the drain basket and the magnet in the tank.
- Clean the specimen holder and the flanges.



HINT:

Leave the guard open when the machine is not in use to let the cutting chamber dry completely.

*Secotom-6
Instruction Manual*

Weekly

Clean Secotom regularly, to avoid damaging effects to the machine and the specimens from abrasive grains or metal particles.

- Clean painted surfaces, and the Front Panel with a soft damp cloth and common household detergents.
For heavy duty cleaning, use Struers Cleaner (Cat. No. 49900027).
- Clean the guard with a soft damp cloth and a common household anti-static window cleaning agent.
- Do not use harsh or abrasive cleaning agents.



NOTE:

Ensure that no detergent or cleaning agent residue is flushed into the cooling unit tank; excess foaming will occur.

Cleaning the Cutting Chamber

- Remove the clamping device(s).
Store the clamping device(s) in a dry place or replace on the cutting table after cleaning.
- Clean the cutting chamber thoroughly.
- Check the drain basket and the magnet.
A blocked drain can result in overflow and insufficient cooling as the level of fluid in the tank is too low.
This could lead to damage to the workpiece or the cut-off wheel.

*Secotom-6
Instruction Manual*

Checking the Cooling Fluid Tank

- Check the level of the cooling fluid after 8 hours use or at least every week. Refill if necessary.

Replace the cooling fluid if it appears dirty (build up of cutting debris).

Remember to add Struers additive, Cooli Additive.

To check the concentration of additive, use a refractometer.

Please see the instructions for use on the label.

It is recommended to change the cooling fluid at least once a month to prevent the growth of microorganisms.



CAUTION

Read the Safety Data Sheet for the additive for cooling fluid before use.

Avoid skin contact with the additive for cooling fluid.

Use of gloves and safety goggles are recommended. Cooling fluid may contain swarf (cutting /grinding debris or other particles).

Cooling Fluid Nozzles

- Should the cooling fluid nozzles become blocked, clear the blockage with a thin piece of wire (e.g. a paper clip).

The screw can be removed from the tip of the right nozzle to aid cleaning.

Tube for Water-free Cooling Fluid

The tube in the cooling fluid pump **MUST** be replaced by a special tube when using Water-free Cutting Fluid. The standard tube will only last for a few hours, as it will be affected by the Water-free Cutting Fluid. The special tube, which is more resistant to the components of the Water-free Cutting Fluid, is available as a Spare Part. (Cat. No. 05996921)

See [Changing Cooling Pump Tubes](#) details of changing the pump tube.

Once mounted, the Tube for Water-free Cooling Fluid must be checked for wear on a regular basis.

The frequency for changing the tube will vary according to specific conditions. It is recommended to visually check the Tube for Water-free Cooling Fluid for wear after every 5 hours of use.

Monthly
*Cleaning the Cooling
Fluid Tank*

Replace the cooling fluid in the Cooling fluid tank at least once a month.

- Slide the cooling fluid tank out gently.



- Remove the screw cap and pour out the used cooling fluid into a drain approved for waste chemicals.
- Rinse the tank with clean water, periodically shaking the tank to release any debris that has accumulated on the bottom of the tank. Repeat the rinsing process until the tank is clean.
- Replace the screw cap.
- Slide the tank back into position.
- Fill the tank by pouring a **4% solution** of Struers additive, Cooli Additive:
190ml Cooli Additive and 4.5 l water
through the hole in the base of the chamber.
- For water-sensitive materials, use Struers Water-Free Cooling Fluid.

NOTE:
Take care not to overfill the tank!



NOTE:
Flush the Recirculation cooling system with clean water if Secotom is not to be used over longer periods of time. This will prevent any dried residue of cutting material from damaging the inside of the pump.

CAUTION



Read the Safety Data Sheet for the additive for cooling fluid before use.
Avoid skin contact with the additive for cooling fluid.
Use of gloves and safety goggles are recommended. Cooling fluid may contain swarf (cutting /grinding debris or other particles).

Yearly Inspection of Guard

The guard consists of a metal frame and a copolyester material that protects the operator. In the event of damage, the guard will be weakened and offer less protection.

- Visually inspect the guard for signs of wear or damage (e.g. dents, cracks).



NOTE:

Carry out inspection at more regular intervals if Secotom is used for more than one 7 hours shift a day.

Replacing the Guard

The guard should be **replaced immediately** if it has been weakened by collision with projectile objects or if there are visible signs of deterioration or damage.



WARNING

To ensure its intended safety, the guard must be replaced **every 2 years**³. A label on the guard indicates when it is due to be replaced.

Testing Safety Devices

The guard has a safety switch system to prevent the cut-off wheel motor from starting while the guard is open. Furthermore, a locking mechanism prevents the operator from opening the guard until the motor stops spinning.



NOTE:

Testing should always be performed by a qualified technician (electromechanical, electronic, mechanic, pneumatic etc.)

Emergency stop

- Start a cutting process.
- Activate Emergency stop.
If cutting does not stop, press STOP ⏹ and contact Struers Service.
- Activate Emergency stop.
- Press START ⏏.
If cutting starts, press STOP ⏹ and contact Struers Service.

3

Replacement of the guard is required to remain compliant with the safety requirements in the European standard EN 16089.

*Secotom-6
Instruction Manual*

Safety lock



- Open the guard.
- Try to move the cutting table with the positioning keys.
If it the cutting table can be moved, contact Struers Service.

- Start a cutting process.
- Try to open the guard – do NOT use force.
If it opens, press STOP ⏹ and contact Struers Service.

- Open the guard.
- Press START ⏻.
If cutting starts, press STOP ⏹ and contact Struers Service.

- Start a cutting process.
- Press STOP ⏹.
If it is possible to open the guard while the cut-off wheel still rotates, contact Struers Service.

Hold-to-run Button

- Open the guard.
- Press FLUSH .
If cooling fluid starts to run, press FLUSH  or STOP ⏹ and contact Struers Service.



WARNING

Do NOT use the machine with defective Safety Devices.
Contact Struers Service.

Spare Parts

Please see [Spare Parts List](#) in the Reference Guide section of the Instruction Manual.

Maintenance of Clamping Devices



NOTE:

It is recommended to thoroughly clean and lubricate the Quick Clamping Device and Vertical Quick Clamping Device at regular intervals.

Maintenance of Cutting Tables

The stainless-steel bands (available as spare parts) should be replaced if damaged or worn.

Turning or Replacing Steel Bands on the Cutting Table

During normal use, it is not uncommon for the cutting table steel bands located on either side of the cutting area to be damaged. If the bands are only damaged on one side, then they can be turned. If they are very badly damaged or damaged on both sides, replace the bands (available as a Spare Part).

Maintenance of Cut-off Wheels

Storing of Abrasive Cut-off Wheels

Abrasive cut-off wheels are sensitive to humidity. Therefore, do not mix new, dry cut-off wheels with used humid ones. Store the cut-off wheels in a dry place, horizontally on a plane support.

Maintenance of Diamond and CBN Cut-off Wheels

The precision of diamond and CBN cut-off wheels (and thus the cut) depends on how carefully the following instructions are observed:

- Never expose the cut-off wheel to a heavy mechanical load, or heat.
- Store the cut-off wheel in a dry place, horizontally on a plane support, preferably under light pressure.
- A clean and dry cut-off wheel does not corrode. Therefore, clean and dry the cut-off wheel before storing. If possible, use ordinary detergents for the cleaning.
- Regular dressing of the cut-off wheel is also part of the general maintenance.

*Secotom-6
Instruction Manual*

*Dressing Diamond and
CBN Cut - off Wheels*

A newly dressed cut-off wheel will give an optimum cut. A badly maintained and dressed cut-off wheel demands a higher cutting pressure that will result in more frictional heat. The wheel may also bend and cause a skew cut. A combination of both factors may result in damage to the cut-off wheel.

To dress the cut-off wheel, use the aluminium oxide dressing stick supplied with the cut-off wheel.

There are two ways to dress a cut-off wheel:

- Clamp the dressing stick like a workpiece.
- Cut through the dressing stick using a moderate feed speed and plenty of cooling fluid.
- Repeat the treatment if the cut-off wheel does not cut satisfactorily.

Or

- Use a Manual Dresser – see Accessories in the [Secotom brochure](#).



NOTE:

Do not perform more dressing than necessary as this will cause needless wear on the wheel.

NOTE:

A badly dressed cut-off wheel is the most frequent reason for damage to the wheel.

Testing Cut-off Wheels

Cut-off wheels must be inspected before use.

To test an abrasive cut-off wheel for damage:

- Visually inspect the surface for cracks and chips.
- Mount the cut-off wheel, close the guard and let it rotate with full speed.

If there is no visible damage and it did not break during the high-speed test, it passed the test. If the cut-off wheel shows cracks, it is unsafe to use.

To test a Diamond/CBN cut-off wheel, perform a ring test:

- Let the cut-off wheel hang over your index finger.
- With a pencil (not metal), gently tap the cut-off wheel around the edge.

The wheel passes the test if it gives a clear metallic tone when tapped. If the wheel sounds dull or muted, it is cracked and unsafe to use.

Changing Cooling Pump Tubes

To exchange the tube:

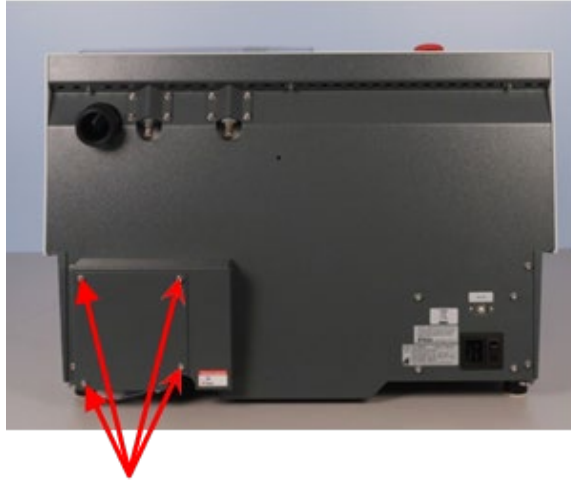

- Remove the four screws on the protection plate on the rear of the machine.

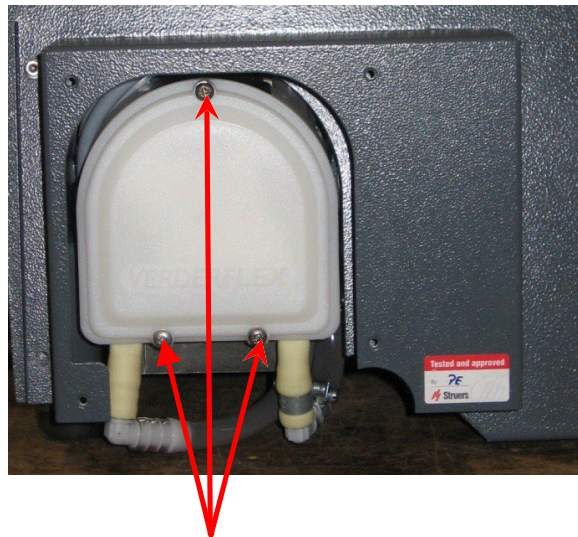

- Remove the three screws on the cover on the cooling pump.

Secotom-6
Instruction Manual

Remove the tube from the pump axle.

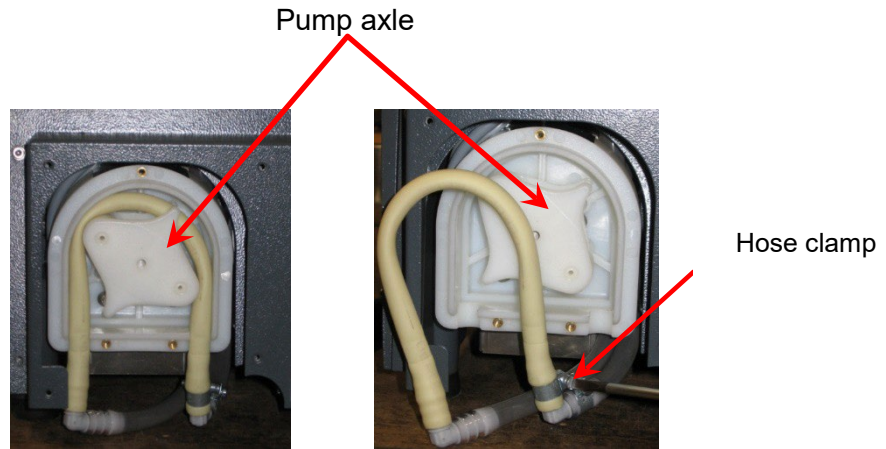

- Loosen the hose clamp and carefully remove the tube ends from the connectors.
- Attach the new tube to the connectors and tighten the hose clamp (the hose clamp should be on the end of the tube that directs water into the cutting chamber, as this will have the greatest pressure – see picture).
- Lubricate the tube along its length with the silicon grease enclosed (this will help the rollers in the pump to turn smoothly).
- Press the tube into position around the pump axle. Mount the tube correctly in the pump:

Correct:

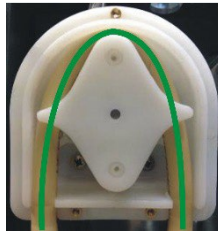

Too loose

Too tight

Incorrect:

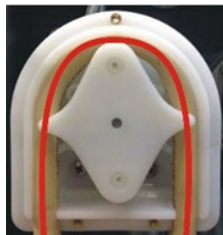

Excess volume between the rollers will press "waves" of fluid which will stretch the tube; lifetime of the tube will be reduced.

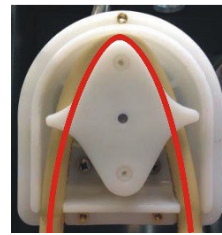

The tube is stretched; lifetime of the tube will be reduced.

- Replace the pump cover and the protection plate.

4. Cautionary Statements



WARNING

The guard should be **replaced immediately** if it has been weakened by collision with projectile objects or if there are visible signs of deterioration or damage.



WARNING

Do NOT use the machine with defective Safety Devices. Contact Struers Service.



WARNING

In case of fire, cut the power alert bystanders and the fire brigade. Use a powder fire extinguisher. Do not use water.



WARNING

To ensure its intended safety, the guard must be replaced after a lifetime of 2 years⁴. A label on the guard indicates when it is due to be replaced.

Other safety critical components are to be replaced after a maximum lifetime of 20 years.

Contact Struers Service for information.

4

Replacement of the guard is required to remain compliant with the safety requirements in the European standard EN 16089.



CRUSHING HAZARD

Take care of your fingers when handling the machine. Wear safety shoes when handling heavy machinery.



ELECTRICAL HAZARD

Switch the power off when installing electrical equipment. The machine must be earthed (grounded).
Check that the mains voltage corresponds to the voltage stated on the type plate on the side of the machine. Incorrect voltage may result in damage to the electrical circuit.



CAUTION

Mind the protruding safety catch when the guard is raised.



CAUTION

Prolonged exposure to loud noises may cause permanent damage to the hearing.
Use hearing protection if exposure to noise exceeds levels set by local regulations.



CAUTION

Read the Safety Data Sheet for the additive for cooling fluid before use.
Avoid skin contact with the additive for cooling fluid.
Use of gloves and safety goggles are recommended. Cooling fluid may contain swarf (cutting /grinding debris or other particles).
Do not start flushing until the flushing hose is pointing into the cutting chamber.

5. Transport and Storage



NOTE:

Store the packing crate, foam packaging, bolts and fittings for future use.

Failure to use the original packaging and fittings could cause severe damage to the tester and will void the warranty.

Follow these steps:

- Clean the machine.
- Disconnect the power supply, and exhaust system.
- Empty the cooling tank.

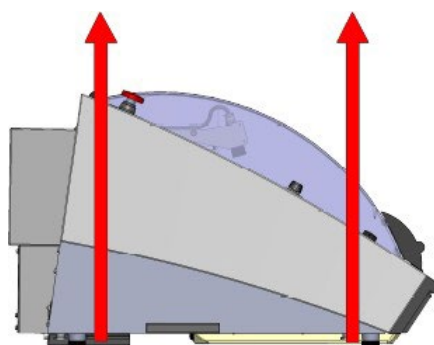

- Position the lifting straps⁵ on Secotom.
- Move it to its new position.
- Replace the cooling tank.

If the machine is bound for long-time storage or shipping, follow these additional steps:

- Place the machine on the blocks on the original pallet.
- Secure the machine using the original transport brackets.
- Build the crate.
- Place the accessories and other loose items in the crate.
- To keep the machine dry, plastic-wrap the machine and place a bag of desiccant (silica gel) with the machine, too.
- At the new location, check that the facilities required are in place.
- Use the [Error! Reference source not found.](#)

5

The crane and the straps must be approved to at least twice the weight of the load.

6. Disposal



Equipment marked with a WEEE symbol  contain electrical and electronic components and must not be disposed of as general waste. Please contact your local authorities for information on the correct method of disposal in accordance with national legislation.

NOTE:

Swarf must be disposed of according to the current safety regulations for handling and disposal of swarf/ additive for cooling fluid.

NOTE:

The cooling fluid will contain additive and cutting swarf and may **NOT** be disposed of into a main drain. Cooling fluid must be disposed of in compliance with local safety regulations.

Please note:

Depending on which metals are being cut, it is possible that the combination of the metallic swarf (cutting debris) from metals with a large difference in electro positivity (a large distance apart in the electrochemical series), could result in exothermic reactions when 'favourable' conditions are present. Therefore, it is always good practice to bear in mind which metals are being cut and the amount of swarf produced.

Examples:

The following are examples of combinations which could result in exothermic reactions if a large amount of swarf is produced during cutting/ grinding on the same machine, and when favourable conditions are present:

Aluminium and Copper Zinc and Copper



WARNING

In case of fire, cut the power alert bystanders and the fire brigade. Use a powder fire extinguisher. Do not use water.

Reference Guide

Table of Contents

Page

1. Struers Knowledge	55
2. Accessories and Consumables	56
Accessories	56
Consumables	56
Cut-off Wheels.....	56
Other consumables	56
3. Trouble-Shooting	57
4. Service	65
Service Check	66
5. Spare Parts and Diagrams	67
Safety Related Parts of the Control System	67
Spare Parts List	68
Circuits and Diagrams	69
6. Legal and Regulatory	75
FCC Notice	75
7. Technical Data.....	76

1. Struers Knowledge

Materialographic cutting is where most microstructure analysis begins. A good understanding of the cutting process can help to select suitable clamping and cutting methods and thereby ensure the high-quality cut. Minimizing cutting artefacts will help the remaining materialographic process and act as a good base for efficient and high-quality preparation.



HINT:

For further information, see the section on [Cutting](#) on the Struers website.

2. Accessories and Consumables

Accessories Please refer to the [Secotom Brochure](#) for details of the range available.

Consumables *The use of Struers consumables is recommended. Other products (e.g. coolants) may contain aggressive solvents, which dissolve e.g. rubber seals. The warranty may not cover damaged machine parts (e.g. seals and tubes), where the damage can be directly related to the use of non-Struers consumables.*

Cut-off Wheels Please refer to the Selection Guide in the [Struers Consumables Catalogue](#).

Other consumables

Specification	Cat. No.
<p>Cooli Additive Additive for recirculation water for cutting and grinding. Additive to improve cutting/grinding and cooling properties and protect the machine from corrosion. Recommended concentration: 4%</p> <p>1 l 4 l</p>	<p>49900074 49900073</p>
<p>Cooli Additive Plus High performance cutting additive for recirculation water. Additive to improve cutting and cooling properties and protect the machine from corrosion. Recommended concentration: 4%</p> <p>1 l 4 l</p>	<p>49900071 49900072</p>
<p>Corrozip-Cu Additive for Cooling Fluid. To protect the machine from corrosion and to improve cutting and cooling qualities. For Recirculation Cooling Unit. For machines which mainly cut copper and copper alloys.</p> <p>1 l 5 l</p>	<p>49900068 49900069</p>
<p>Water-free Cutting Fluid Water free Cutting Fluid for cutting of watersensitive materials</p> <p>5 l</p>	<p>49900070</p>
<p>Tube for Water-free Cutting Pump tube for use with Water-free Cutting Fluid</p> <p>1 pc.</p>	<p>05996921</p>
<p>Dressing stick Aluminium oxide stick.</p> <p>1 pc.</p>	<p>40800044</p>

3. Trouble-Shooting

No.	Message	Explanation	Action Required
#8	<p>Question #8</p> <p>Selected cut length exceeds available cutting capacity.</p> <p>OK: Automatic cut length will be set. Cancel: Go back to Edit method.</p> <p>↩: Cancel ←: OK</p>	Insufficient cutting capacity for set length.	Select <i>OK</i> to set cut length automatically or <i>Cancel</i> to edit method.
#106	<p>Fatal error #106</p> <p>Machine failed during Power-On Self Testing. Please try to restart. If problem persists please contact Struers technical support.</p> <p>Unknown error!</p> <p>←: OK</p>	A critical error is detected during Power-ON Self Testing. The machine will not start.	Re-start. If error remains, contact Struers Service.
#110	<p>Warning #110</p> <p>Machine found a problem during Power On Self Testing. Machine can continue, however it is strongly recommended to contact Struers technical support. Some features may not be available. Unknown warning!</p> <p>←: OK</p>	A critical error is detected during Power-ON Self Testing.	Re-start. If error remains, contact Struers Service.
#113	<p>Information #113</p> <p>Water pump blocked!</p> <p>←: OK</p>		Check the cooling fluid level. If the level is low, refill the cooling tank with cooling fluid. Replace the cooling fluid if it appears dirty (build-up of cutting debris). If this does not help, contact Struers Service.
#114	<p>Information #114</p> <p>Machine is searching for reference positions. Please wait... Don't switch the machine off!</p>	Zero positions are calibrated after each 5th start-up, or if reference position has been lost or if Emergency Stop has been activated under start-up.	Wait until the process is completed.
#117	<p>Information #117</p> <p>Water pump blocked! Process halted! Clean cooling system before continuing.</p> <p>←: OK</p>		Check the cooling fluid level. If the level is low, refill the cooling tank with cooling fluid. Replace the cooling fluid if it appears dirty (build-up of cutting debris). If this does not help, contact Struers Service.

*Secotom-6
Instruction Manual*

No.	Message	Explanation	Action Required
#119	<p>Information #119</p> <p>Main motor overload detected! Process halted! Reduce feed speed before continuing.</p> <p>←: OK</p>	The cut-off wheel may be caught in the workpiece.	Move the cutting table backwards to release the cut-off wheel, reduce the feed speed and continue cutting.
#125	<p>Information #125</p> <p>Main motor overheated! Cutting process halted! Please wait until motor temperature decreases before continuing cutting.</p> <p>←: OK</p>	The temperature of the main motor has been over 150°C for more than 5 sec.	Wait for the motor to cool.
#126	<p>Information #126</p> <p>Main motor cannot start. Process halted! Please try to restart the machine if problem occurs after next start.</p> <p>Error code: 0</p> <p>←: OK</p>		Switch Secotom off and then on. If this does not help, contact Struers Service.
#127	<p>Information #127</p> <p>Main motor rotation lost. Process halted! Try to restart cutting process.</p> <p>Error code: 0</p> <p>←: OK</p>	The cutting process has been aborted.	Make a note of the Alarm register and Error register values then restart the Cutting process. If this does not help, contact Struers Service and quote the Alarm and Error register values.
#129	<p>Warning #129</p> <p>Process cannot start without valid reference positions. Restart the machine to find reference positions.</p> <p>←: OK</p>	Emergency stop has been activated whilst Secotom has been scanning for zero-positions.	Restart the machine and wait until the scan for zero-positions is complete.
#130	<p>Information #130</p> <p>Motor drive overloaded! Wait before continuing. Consider decrease of feed speed.</p> <p>←: OK</p>	The load on the motor has caused an overload.	Decrease the RPM and/or feed speed before continuing cutting.

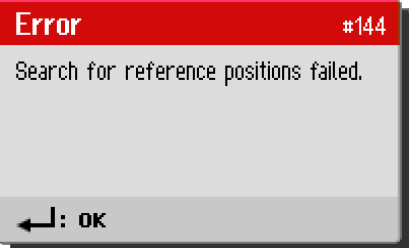
No.	Message	Explanation	Action Required
#144		No power detected on stepper motors during attempt to reference positions.	Confirm the dialog and reboot the machine. Reference searching procedure will be repeated each restart until valid ref positions are found.

*Secotom-6
Instruction Manual*

No.	Message	Explanation	Action Required
Errors			
#001	SMM not present!	Struers Memory Module is not correctly connected to machine.	Re-start. If error remains, contact Struers Service.
#002	Inverter communication failed!	Machine is not able to communicate with frequency inverter.	Re-start. If error remains, contact Struers Service.
#004	Mains voltage too low!	Mains voltage lower than 220V.	Check that the mains voltage corresponds to the voltage stated on the type plate on the rear of the machine. Re-start. If error remains, contact Struers Service.
#005	Problem with 24V supply voltage	DC supply voltage lower than 18V.	Re-start. If error remains, contact Struers Service.
#006	5V supplying out of range	5V power supply on PCB is lower than 4V	Re-start. If error remains, contact Struers Service.
#007	SMM read-write test failed	Communication with Struers Memory Module unsuccessful	Re-start. If error remains, contact Struers Service.
#008	Y-table motor not connected	Communication with the Y-table Stepper Motor Unit failed.	Re-start. If error remains, contact Struers Service.

No.	Message	Explanation	Action Required
Warnings			
#001	Mains voltage too low	Mains voltage is lower than 180V.	Check that the mains voltage corresponds to the voltage stated on the type plate on the rear of the machine. Re-start. If error remains, contact Struers Service.

Error	Explanation	Action
Machine Problems		
No, or insufficient cooling fluid.	Level in the cooling fluid tank too low.	Check that there is sufficient water in the Cooling fluid tank.
	Cooling fluid nozzles blocked.	Clean the nozzles.
Water leaking.	Leak in the Cooling fluid tube.	Check the Cooling Pump Tube. Replace if necessary.
	Water overflow in the cooling fluid tank.	Remove the excess water.
	The basket for cutting debris is blocked.	Clean the basket.
Workpieces rusty.	Insufficient additive in cooling fluid.	Check the concentration of Cooli Additive in the cooling fluid. Follow the instructions in the Maintenance Section.
Cutting chamber rusty.	Insufficient additive in cooling fluid.	Check the concentration of Cooli Additive in the cooling fluid. Follow the instructions in the Maintenance Section.
	The guard is left closed after use.	Leave the guard open to let the cutting chamber dry.
Cutting chamber shows signs of corrosion.	The workpiece is made of Copper/ Copper Alloy.	Use Corrozip-Cu.

*Secotom-6
Instruction Manual*

Error	Explanation	Action
Cutting Problems		
Discoloration or burning of the workpiece.	The hardness of the cut-off wheel is inappropriate for the hardness / dimensions of the workpiece.	Select another wheel. Please refer to the Brochures for details of the range available. Alternatively, reduce rotational speed.
	Inadequate cooling.	Check the positioning of the cooling fluid nozzles. If necessary, clean the nozzles.
		Check that there is sufficient water in the Cooling fluid tank.
		Check the concentration of Cooli Additive in the cooling fluid.
Unwanted burrs.	Cut-off wheel too hard.	Select another wheel. Please refer to the Brochures for details of the range available. Alternatively, reduce rotational speed
	Feed speed too high at the end of the operation.	Reduce the feed speed near the end of the operation.
	Incorrect clamping of the workpiece.	Support the workpiece and clamp it on both sides. e.g. Struers' Specimen Holder CATAL, which is designed for clamping small, long workpieces on both sides.
Cutting quality differs.	Inadequate cooling.	Check the positioning of the cooling fluid nozzles. If necessary, clean the nozzles.
		Check that there is sufficient water in the Cooling fluid tank.
		Check the concentration of Cooli Additive in the cooling fluid.

Error	Explanation	Action
Cut-off wheel breaks.	Incorrect mounting of the cut-off wheel.	Check that the bore/centre hole has the correct diameter. The nut must be tightened properly.
	Incorrect clamping of the workpiece.	Support the workpiece and clamp it on both sides. e.g. Struers' Specimen Holder CATAL, which is designed for clamping small, long workpieces on both sides.
	Cut-off wheel is too hard.	Select another wheel. Please refer to the Brochures for details of the range available. Alternatively, reduce rotational speed.
	Feed speed is set too high.	Reduce the feed speed.
	Force level is set too high.	Reduce the Force level.
	Cut-off wheel bends on contact with the workpiece.	Make an initial cut at a lower feed speed.
The cut-off wheel wears down too quickly.	The feed speed is too high.	Reduce feed speed.
	The rotational speed is too low.	Increase rotational speed.
	Insufficient cooling.	Check that there is enough water in the Cooling fluid tank. Check the positioning of the cooling fluid nozzles. If necessary, clean the nozzles
The cut-off wheel does not cut through the workpiece.	The rotational speed is too low.	Increase rotational speed.
	Incorrect choice of cut-off wheel.	Please refer to the Brochures for details of the range available.
	Cut-off wheel worn.	Replace the cut-off wheel.

*Secotom-6
Instruction Manual*

Error	Explanation	Action
The workpiece breaks when clamped.	The cut-off wheel gets caught in the workpiece during cutting.	Clamp the workpiece on both sides of the cut-off wheel so that the cut stays open. e.g. Struers' Specimen Holder CATAL, which is designed for clamping small, long workpieces on both sides.
	The workpiece is brittle.	Place the workpiece between two plastic/rubber plates. Alternatively, mount the workpiece in resin. <i>Note!</i> Always cut brittle workpieces very carefully.
The specimen is corroded.	The specimen has been left in the cutting chamber for too long.	Remove the specimen directly after cutting. Leave the cutting chamber guard open when you leave the machine.
	Insufficient additive for cooling fluid.	Check the concentration of Cooli Additive in the cooling fluid.

4. Service

Secotom offers extensive information about the conditions of all different components.



HINT:
Service information is only available in English

To reach this function:
Go to the *Maintenance* menu and select: *Service information*.

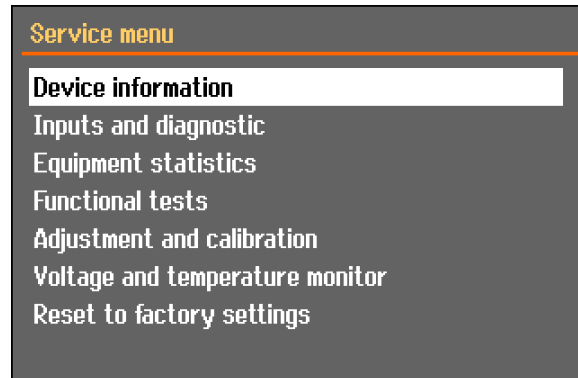

Various topics can be selected for information on the condition of the different components.

Service information can also be used in cooperation with Struers Service for remote diagnostics of the equipment.

Service information is read-only information, machine settings cannot be changed or modified.

Information on total operation time and servicing of the machine is displayed on the screen at start-up:

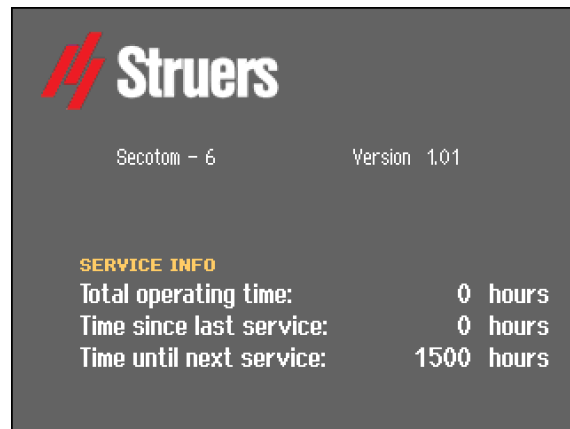

A reminder will appear after 1,400 hours operation time to remind the user that a service check should be scheduled.

*Secotom-6
Instruction Manual*

After the 1,500 hours operation time has been exceeded the Service-Info will change to alert the user that the recommended service interval has been exceeded: "Service period expired!"

- Contact Struers Service to service the machine.

Service Check

Struers recommends that a regular service check be carried out after every 1,500 hours of use.



NOTE:

Servicing may only be performed by a Struers engineer or a qualified technician (electromechanical, electronic, mechanical, pneumatic, etc.). Contact Struers Service for information.

Struers offers a range of comprehensive maintenance plans to suit the requirements of our customers. This range of services is called **ServiceGuard**.

The maintenance plans include equipment inspection, replacement of wear parts, adjustments/calibration for optimal operation, and a final functional test.

5. Spare Parts and Diagrams

For further information, or to check the availability of other replacement parts, please contact your local Struers Service department. Contact information is available on Struers.com.

Safety Related Parts of the Control System (SRP/CS)

Safety Related Part	Manufacturer / Manufacturer Description	Manufacturer Cat. no.
Safety relay	Omron	G9SB
Safety sensor	Schmerzal	BNS 120-02Z
Inverter	ATV	ATV320U11M2C
Relay 24VAC/DC	Finder	38.51.0.024.0060
Emergency Stop button	Schlegel Latching Mushroom Head	ES Ø22 type RV
Emergency Stop contact	Schlegel Modular Contact, momentary	1 NC type MTO
Module holder	Schlege Module holder. 3 elem. MHR-3	MHR-3
Hold-To-Run button	Schurter Metal line swiches	1241.6931.1120000
Guard lock	Schmerzal	AZM170SK-11/02ZRK-2197 24VAC/DC
Guard	Struers	16850044

Struers' Cat. nos. are listed in the Spare Parts list.



WARNING

The guard must be replaced after a **lifetime of 2 years**. **Other** safety critical components are to be replaced after a maximum lifetime of **20 years**.

Contact Struers Service for information.



NOTE:

Replacement of Safety critical components can only be performed by a Struers engineer or a qualified technician (electromechanical, electronic, mechanical, pneumatic, etc.).
Safety critical components may only be replaced by components with at least the same safety level.

Contact Struers Service for information.

Spare Parts List

Spare Part	EI.Ref.	Cat no:
Safety relay	KS1, KS2	2KS10006
Safety sensor	SS1	2SS00130
Inverter	A2	2PU12076
Relay 24VAC/DC	K3, K4	2KL23851
Emergency Stop button	SB1	2SA10400
Emergency Stop contact	SB1	2SB10071
Module holder	SB1	2SA41603
Hold-To-Run button	S2	2SA00023
Guard lock	YS1	2SS00025
Guard	-	16852901

Circuits and Diagrams

<u>Block Diagram, Secotom-6</u>	<u>16853051B</u>
<u>Circuit Diagram, Secotom-6 (3 pages)</u>	<u>16853101C</u>
<u>Water Diagram, Secotom</u>	<u>16851005A</u>

See the following pages.

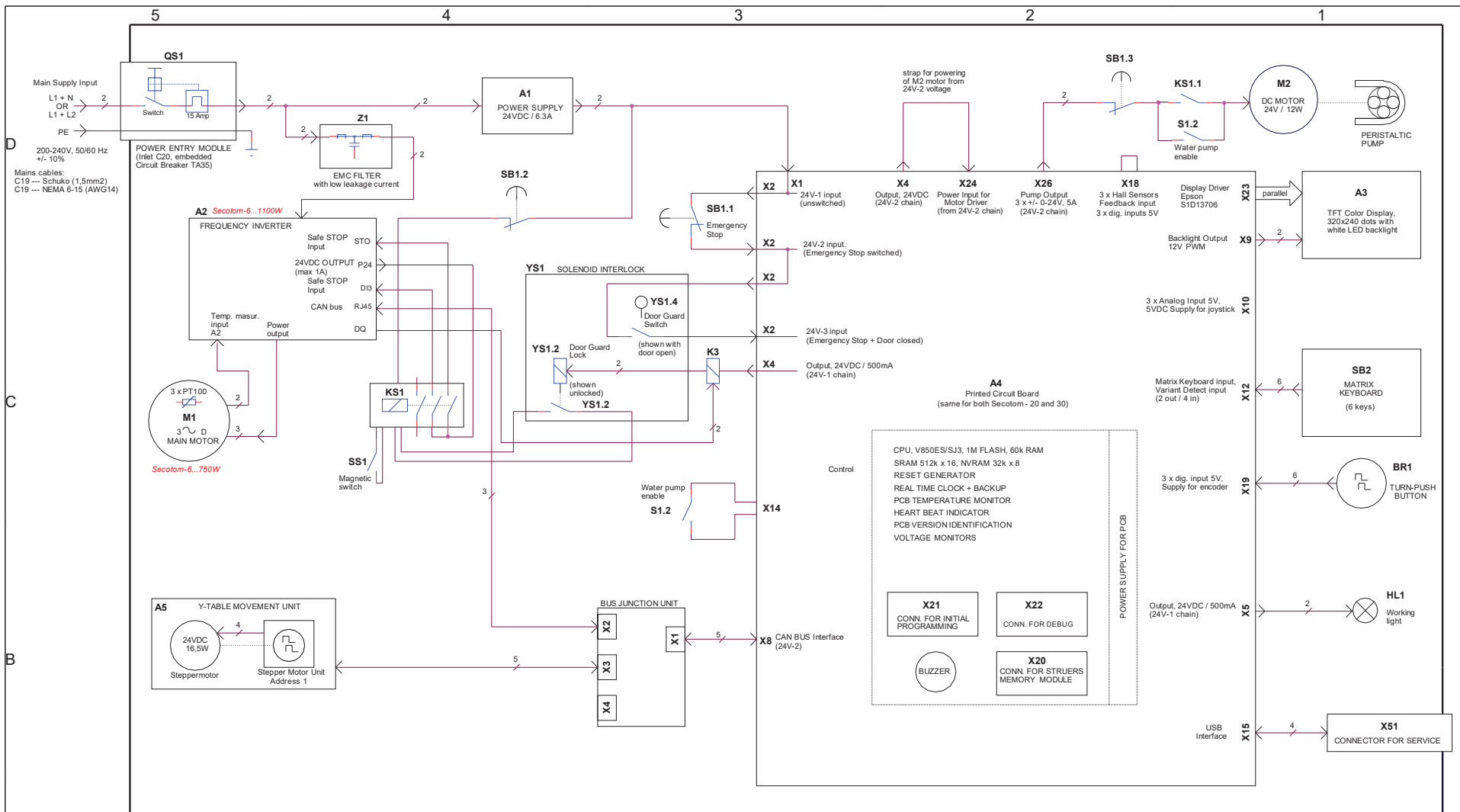

Voltsages related to the safety features:
24V-1: Unprotected voltage from 24VDC power supply
24V-2: Protected by Emergency Stop only
24V-3: Protected by Emergency Stop and Door switch

rev. B (EGA) - corrected Drawing No.	B STRUIERS A/S Petersvej 84 DK-2750 Ballerup Denmark		
Secotom - 6, Block Diagram			
Size A2	CAGE Code	DWG NO 16853051	Rev B
Friday, June 21, 2019	Scale	EGA	Sheet 1 of 1

External short circuit protection according to local regulations.

Main Supply Input
200-240V, 50/60 Hz
+/- 10%

Mains cables:
C19 --- Schuko (1,5mm²)
C19 --- NEMA 6-15 (AWG14)

POWER ENTRY MODULE
(Inlet C20, embedded
Circuit Breaker TA35)

CAUTION - Risk of electric shock.
Disconnect all power and wait 15 min.
before servicing

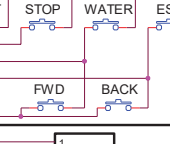
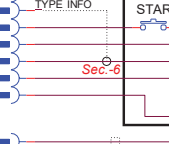
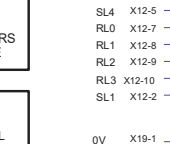
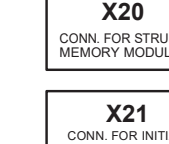
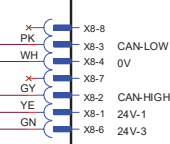
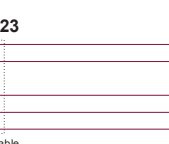
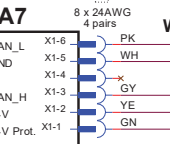
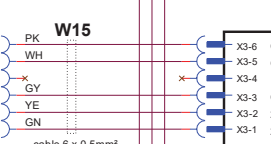
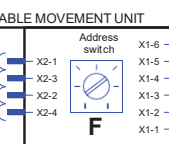
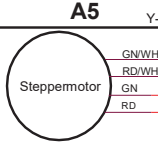
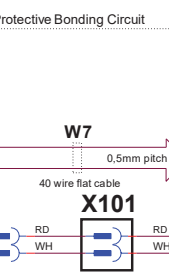
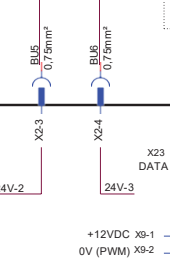
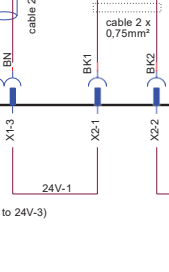
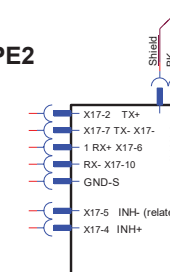
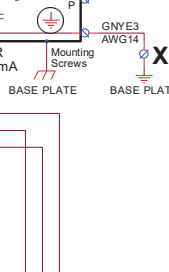
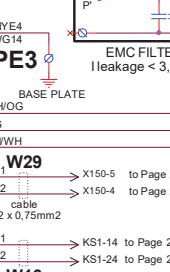
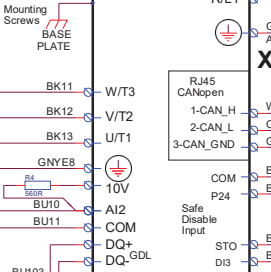
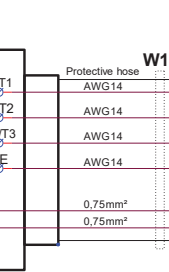
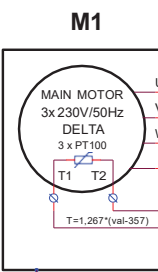

COLOR CODE:
BK = black
BN = brown
RD = red
OG = orange
YE = yellow
GN = green
BU = blue
VT = violet
GY = grey
WH = white
PK = pink
BE = beige
RO = rose
GNYE = yellow-green

rev. B (EGA) Changed W22 cable w. colors		STRUERSS A&S Peterstrømgade 84 DK-2750 Ballerup Denmark +45 44 660 800	
rev. C (EGA) Z1-added L.P. labels, A2 input power labels		Secotom - 6, Circuit Diagram Machine	
Size	CAGE Code	DWG NO	Rev
A2		16853101	C
Scale	EGA	Sheet	1 of 3

Friday, June 21, 2019

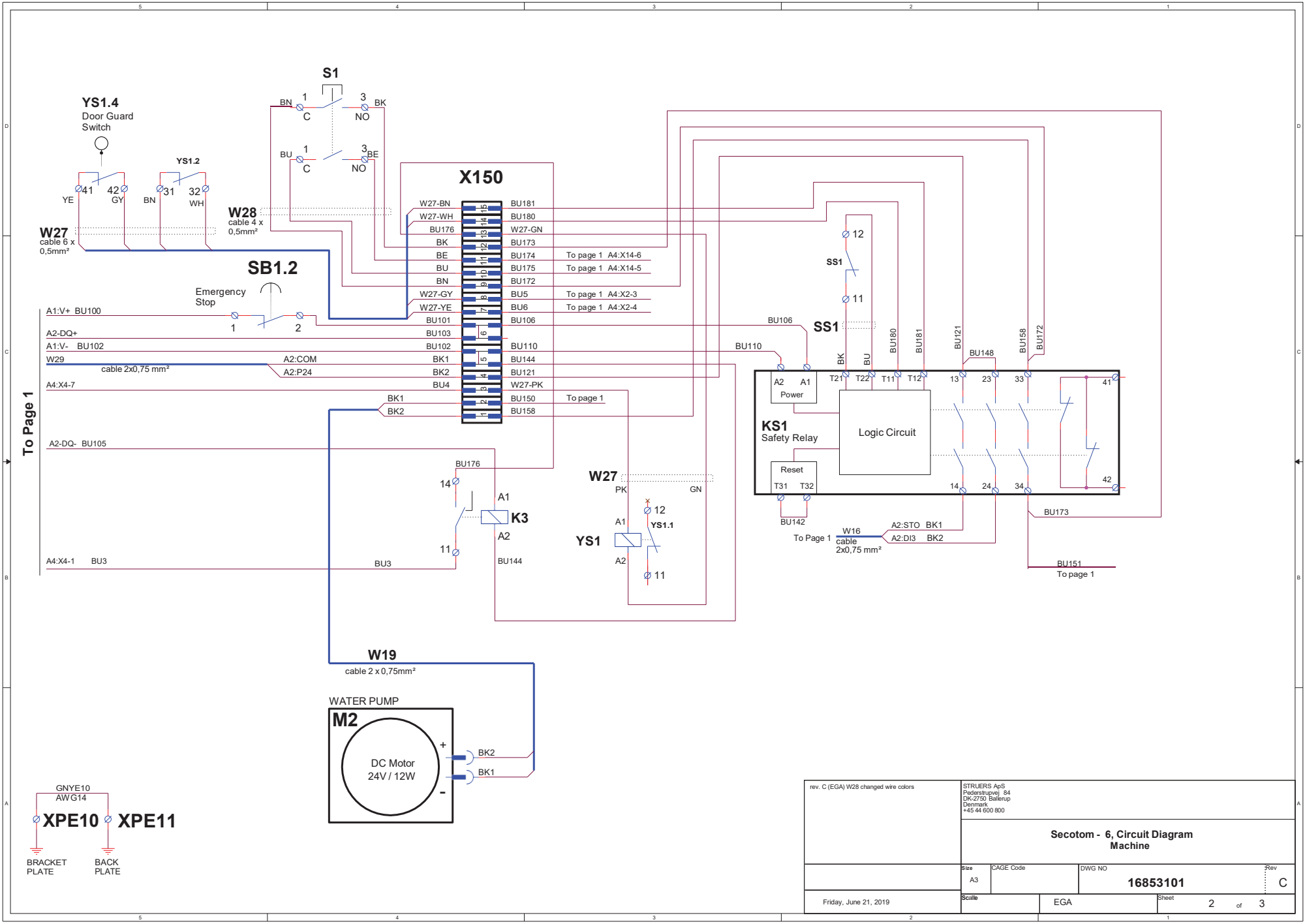

rev. C (EGA) W28 changed wire colors		STRUERS ApS Føderistræde 84 DK-2730 Ballerup Denmark +45 44 600 800	
Secotom - 6, Circuit Diagram Machine			
Size A3	CAGE Code	DWG NO 16853101	Rev C
Friday, June 21, 2019	Scale	EGA	Sheet 2 of 3

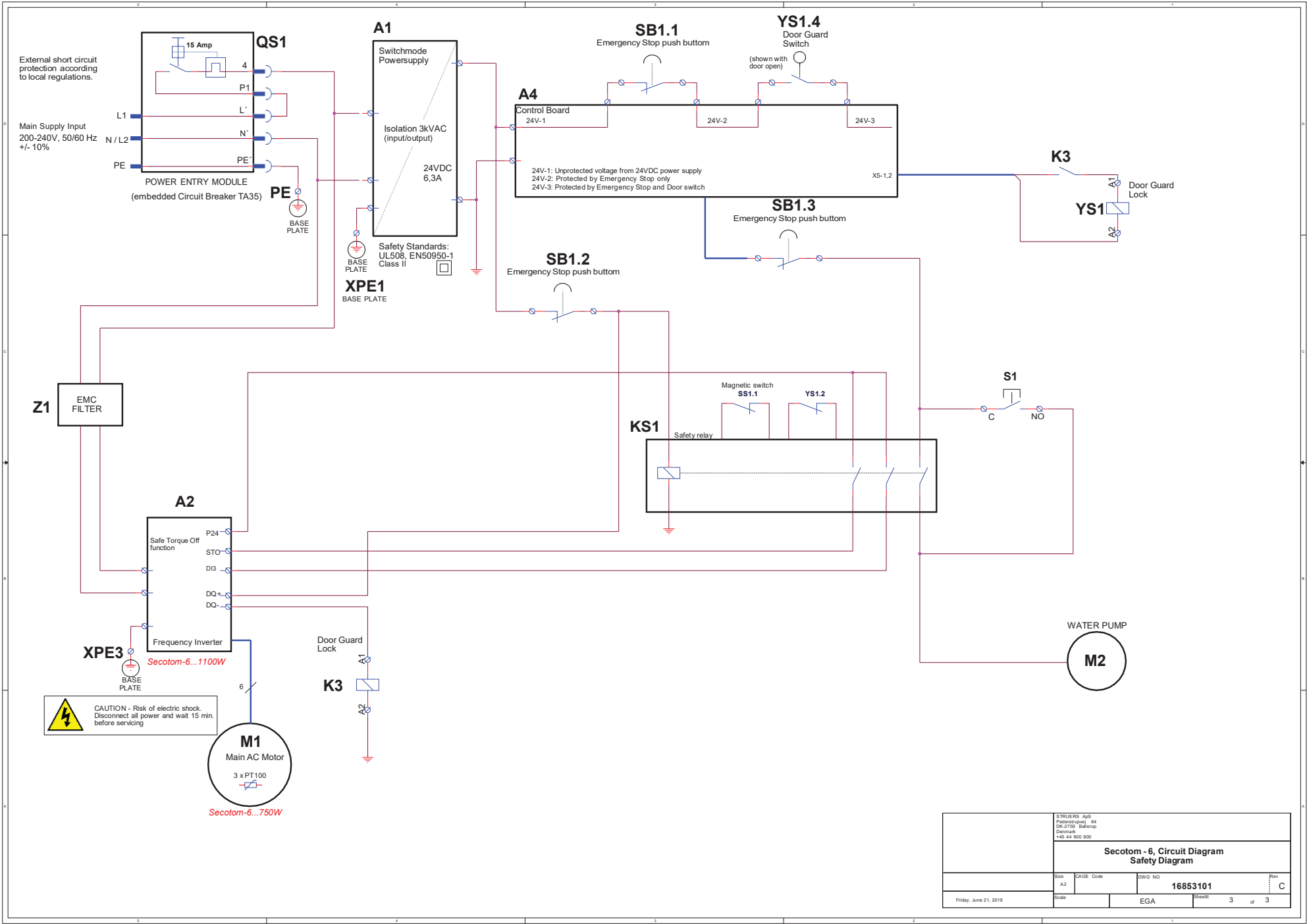

STRUERS A/S Petersstrøje 84 DK-7170 Ballinge Denmark +45 44 950 800	
Secotom - 6, Circuit Diagram Safety Diagram	
Size A2	CAGE Code DWG NO 16853101
Scale Friday, June 21, 2019	EGA Sheet 3 of 3

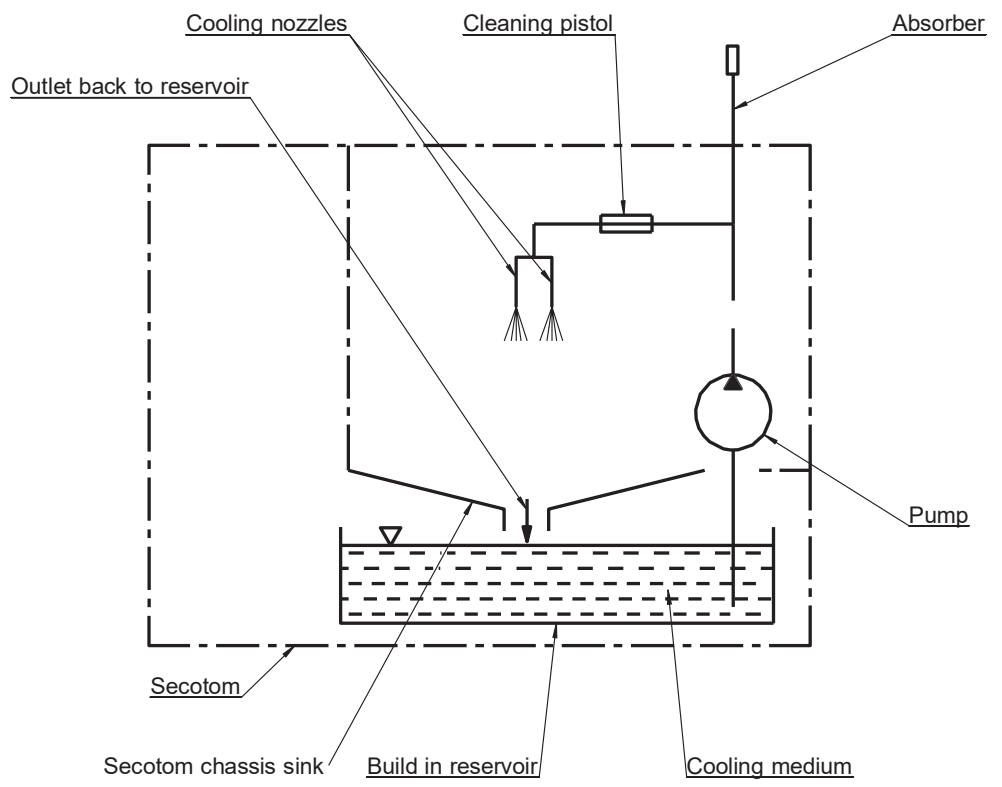

A	2018-11-07	Release	SCA	2018-11-07	ABG
Revision	Crea. date yyyy-mm-dd	Revision description	Draw. Init	Appr. date yyyy-mm-dd	Appr. Init
 Pederstrupvej 84 DK-2750 Ballerup/Copenhagen Denmark Phone: +45 44 600 800 Fax: +45 44 600 804		Material:	Scale: 1:1	Format: A3	Tolerance: DS/ISO 2768- Weight: g
		ID:	Description: 16851005 Water diagram		Rev: A

6. Legal and Regulatory

FCC Notice

This equipment has been tested and found to comply with the limits for a Class A digital device, pursuant to Part 15 of the FCC Rules. These limits are designed to provide reasonable protection against harmful interference when the equipment is operated in a commercial environment. This equipment generates, uses, and can radiate radio frequency energy and, if not installed and used in accordance with the Instruction Manual, may cause harmful interference to radio communications. Operation of this equipment in a residential area is likely to cause harmful interference in which case the user will be required to correct the interference at his own expense.

Pursuant to Part 15.21 of the FCC Rules, any changes or modifications to this product not expressly approved by Struers ApS could cause harmful radio interference and void the user's authority to operate the equipment.

EN ISO 13849-1:2015

All SRP/CS are limited to a lifetime of 20 years. After expiration of this period, all components must be replaced.

7. Technical Data

Subject		Specifications
Cutting	Motor	750 W
	<i>Cutting Power</i>	
	S1	0.75 kW
	S3	1.0 kW
	Cut-off wheels	ø75 mm (3") - 203 mm (8")
	<i>Output axle</i>	
	Rotational speed:	1000 - 3,000 rpm (in steps of 100 rpm)
	Diameter:	12.7 / 22 mm (0.5 / 0.86")
Positioning & Feed	Positioning range (of cutting table)	0 – 200 mm (0 – 7.5") (in steps of 0.1 mm)
	Max. positioning speed of table	10 mm/s / 0.4"/s
	Feed Speed range of table	0.005 – 3 mm/s (0.2 – 120 Mil/s) (in steps of 0.005 mm/s / 0.2 Mil/s)
Cutting Table dimensions	Width	258 mm / 10.2"
	Depth	184 mm / 7.2"
	T-slots	8 mm / 0.3"
Cutting Capacity		42 mm (1.7") dia 42 x 170 mm (1.7" x 6.7")
Recirculation Cooling Tank	Capacity:	4.75 l / 1.25 gallon
	Flow:	1.6 l/min / 0.4 gallon/min
Noise level⁶	A-weighted sound emission pressure level at workstations	L _{PA} = 66 dB(A) (measured value) Uncertainty K = 4 dB(A) Measurements made in accordance with EN ISO 11202.

6

Noise level: The figures quoted are emission levels and are not necessarily safe working levels. While there is a correlation between the emission and exposure levels, this cannot be used reliably to determine whether or not further precautions are required. Factors that influence the actual level of exposure of the workforce include characteristics of the work room, the other sources of noise, etc., i.e. the number of machines and other adjacent processes.

Also, the permissible exposure level can vary from country to country. This information, however, will enable the user of the machine to make a better evaluation of the hazard and risk.



*Secotom-6
Instruction Manual*

Subject		Specifications
Operating environment	Surrounding temperature	5-40 °C / 41-104 °F
	Humidity	35-85 % RH non-condensing
Storage Conditions	Temperature	0 – 55 °C / -13 – 131 °F
Supply	Voltage / frequency	200-240 V / 50-60 Hz
	Power inlet	1-phase (N+L1+PE) or 2-phase (L1+L2+PE) The electrical installation must comply with "Installation Category II".
	Power, nominal load	750 W
	Power, idle	13 W
	Current, nom.	4.6 A
	Current, max.	13 A
	Ampere rating of the largest motor or load	3.1 A
EU Directives	Please refer to the Declaration of Conformity	
Stop Mechanisms	Guard safety switch system	EN60204-1, Stop Category 3 EN ISO 13849-1, Cat. 3, PL e
	Guard lock	EN60204-1, Stop Category 0 EN ISO 13849-1, Cat. 3, PL b
	Hold-to-run function	EN60204-1, Stop Category 3 EN ISO 13849-1, Cat. 3, PL d
	Emergency stop	EN60204-1, Stop Category 3 EN ISO 13849-1, Cat. 1, PL c
	Unintended start of fluid system	EN ISO 13849-1, Cat. 3, PL b
	Axis speed Monitoring - Y- Table movement	EN60204-1, Stop Category 0 EN ISO 13849-1, Cat. 3, PL d
	Cut-off wheel monitoring and speed limitation	EN ISO 13849-1, Cat. 3, PL d
Exhaust	Dimension	50 mm / 2" dia. Minimum capacity: 30 m ³ /h / 1,060 ft ³ /h at 0 mm / 0" water gauge.
Dimensions	Height:	44 cm / 17" (guard closed) 106 cm / 42" (guard open)
	Width	65 cm / 25"
	Depth	78.5 cm / 30.9" (with plug)
	Weight	67 kg / 148 lbs

Secotom-6, Pre-Installation Checklist

**Read the Installation instructions in the Instruction Manual
before
installing the machine.**

Installation Requirements

- Crane and 2 lifting straps⁷
- Screwdriver/ bit: TX30 , PH2  and H4 

Required Accessories and Consumables (ordered separately)
(Please refer to the [Secotom Brochure](#) and the [Struers Consumables Catalogue](#) for details of the range available).

Recommended
Exhaust system: 30 m³/h / 1,060 ft³/h at 0 mm/0" water gauge

Crating Specifications

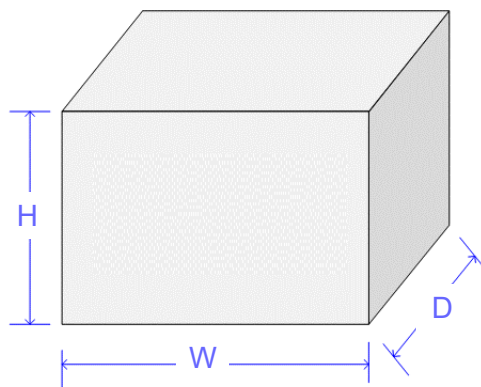

Secotom-6	
H	88 cm / 34.6"
W	92 cm / 36"
D	92 cm / 36"
Weight	110 kg / 243 lbs

⁷

Straps must be approved for at least twice the weight of the load.

Unpacking

- Carefully open and remove the sides and the top of the packing crate.
- Remove the transport brackets securing the machine to the pallet.

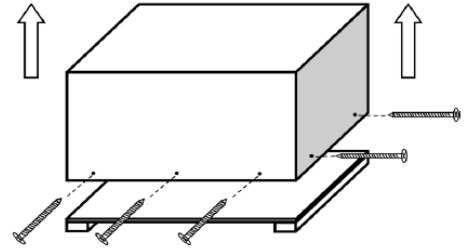

Location

- The machine must be placed close to the power supply.
- The machine is designed to be placed on a rigid, stable workbench with a horizontal surface.

Recommended dimensions:

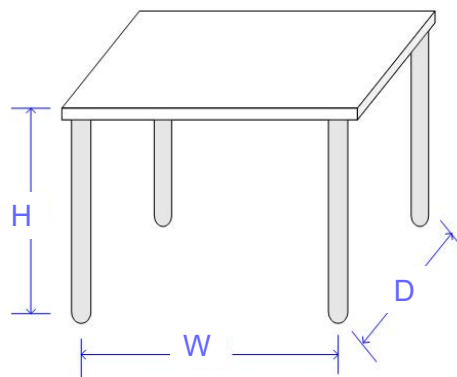

H	80 cm / 31.5"
W	92 cm / 36.2"
D	90 cm / 35.4"

Recommended workbench dimensions.

Height of table (H) follows local preferences.

- To facilitate easy access for service technicians, allow sufficient space around the machine.



HINT:

A table unit designed for Struers' table top machines is available as an accessory Cat. No. 06266101.

Recommended Space

Front:

Recommended space at the front: 100 cm / 40".

Rear:

The machine may be placed against a wall.

- Check there is enough room behind the table for the cover to be opened fully (see illustration).
- Check there is approx. 15 cm / 5.9" behind the machine for the exhaust hose.

Dimensions

Front

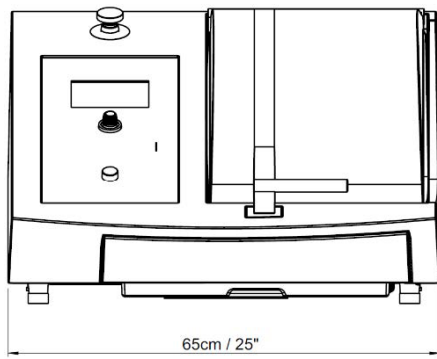

Side

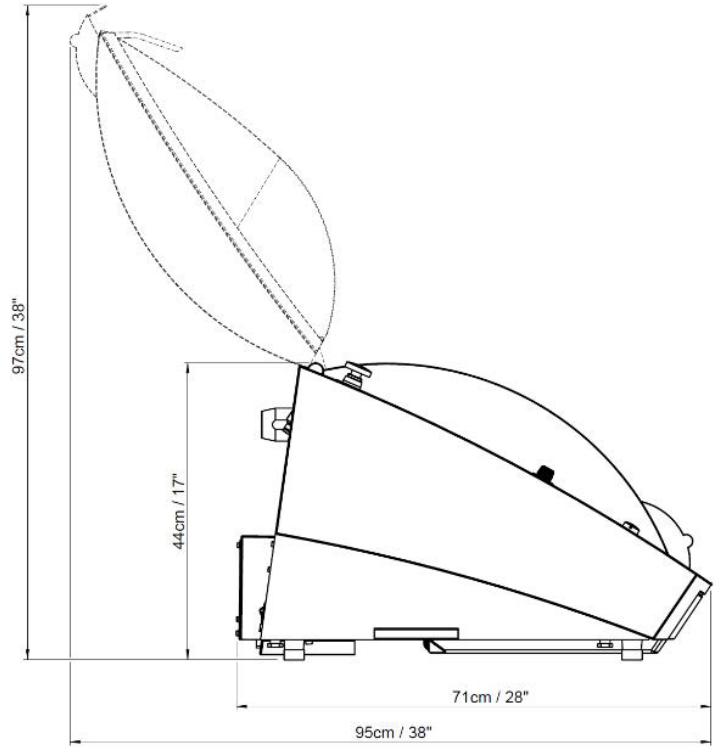

Centre of Gravity

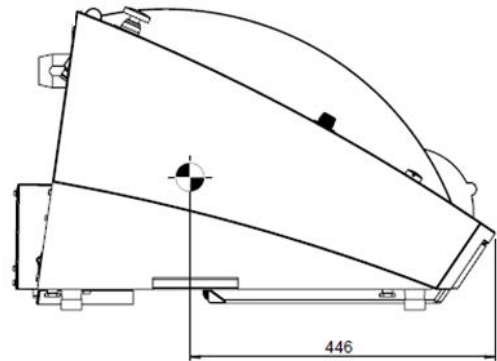
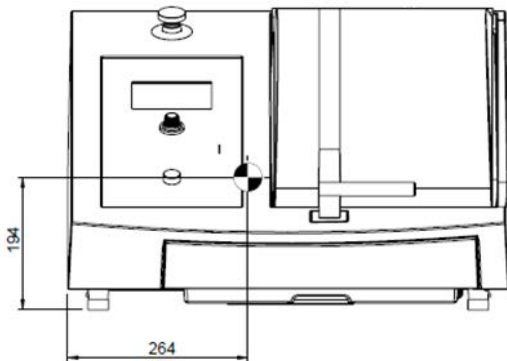

Lifting



NOTE:

Do not lift Secotom using the light grey body.
Remove the recirculation tank before lifting Secotom.
Always lift from underneath the machine.

With a crane

A crane and 2 lifting straps are required to lift the machine off the shipment pallet. A lifting bar is recommended so that the two straps are kept apart below the lifting point.

- Remove the recirculation tank.
- Place the two lifting straps under Secotom.
 - Position the straps under Secotom, so that they are on the inside of the feet. See drawing.

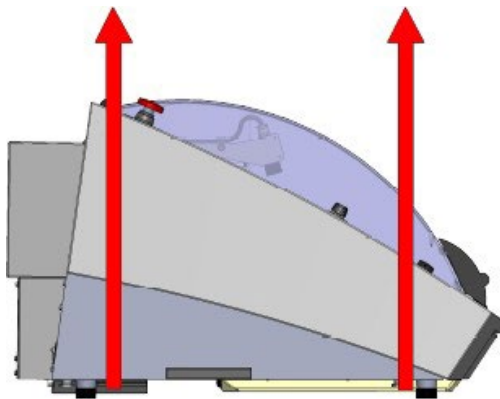

- Lift Secotom onto the table.
- Lift the front of Secotom and carefully move into place.

Power Supply

The machine shipped with 2 types of Mains cables (length 2.5 m/ 8.2').

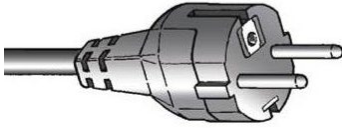

The 2-pin (European Schuko) plug:
- single-phase connections.

If the plug supplied on this cable is not approved in your country, then the plug must be replaced with an approved plug.

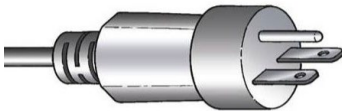

The 3-pin (North American NEMA 6-15P) plug:
- 2-phase connections.

If the plug supplied on this cable is not approved in your country, then the plug must be replaced with an approved plug.

Electrical data

Voltage / frequency	200-240 V / 50-60 Hz
Power inlet	1-phase (N+L1+PE) or 2-phase (L1+L2+PE) The electrical installation must comply with "Installation Category II".
Power, nominal load	750 W
Power, idle	13 W
Current, nom.	4.6 A
Current, max.	13A

Safety Specifications

Safety Circuit Categories

Designed to comply with a minimum of	
Guard safety switch system	EN60204-1, Stop Category 3 EN ISO 13849-1, Cat. 3, PL e
Guard lock	EN60204-1, Stop Category 0 EN ISO 13849-1, Cat. 3, PL b
Hold-to-run function	EN60204-1, Stop Category 3 EN ISO 13849-1, Cat. 3, PL d
Emergency stop	EN60204-1, Stop Category 3 EN ISO 13849-1, Cat. 1, PL c
Unintended start of fluid system	EN ISO 13849-1, Cat. 3, PL b
Axis speed Monitoring - Y-Table movement	EN60204-1, Stop Category 0 EN ISO 13849-1, Cat. 3, PL d
Cut-off wheel monitoring and speed limitation	EN ISO 13849-1, Cat. 3, PL d
Axis speed Monitoring - Vertical axis movement (Secotom-60 only)	EN ISO 13849-1, Cat. 3, PL d

Secotom-6,
Pre-Installation Checklist

Water Supply	<input type="checkbox"/> Required	<input checked="" type="checkbox"/> Option
---------------------	--	---

Cooling fluid is supplied from the integrated recirculation unit (capacity 4.75 l / 1.25 gallon).
A kit for connection to an external recirculation unit is available as an optional accessory.

Water outlet – Drain	<input type="checkbox"/> Required	<input type="checkbox"/> Option
-----------------------------	--	--

The machine is supplied with a small drain hose, which directs the cooling fluid into the recirculation unit.

Compressed air	<input type="checkbox"/> Required	<input type="checkbox"/> Option
-----------------------	--	--

Not required.

Exhaust	<input type="checkbox"/> Required	<input checked="" type="checkbox"/> Option
----------------	--	---

Recommended:
Minimum capacity: 30 m³/h / 1,060 ft³/h at 0mm /0" water gauge.

Exhaust connection:
The machine is supplied with an exhaust hose 1.5 m / 4.9' long with a diameter 50 mm / 2"

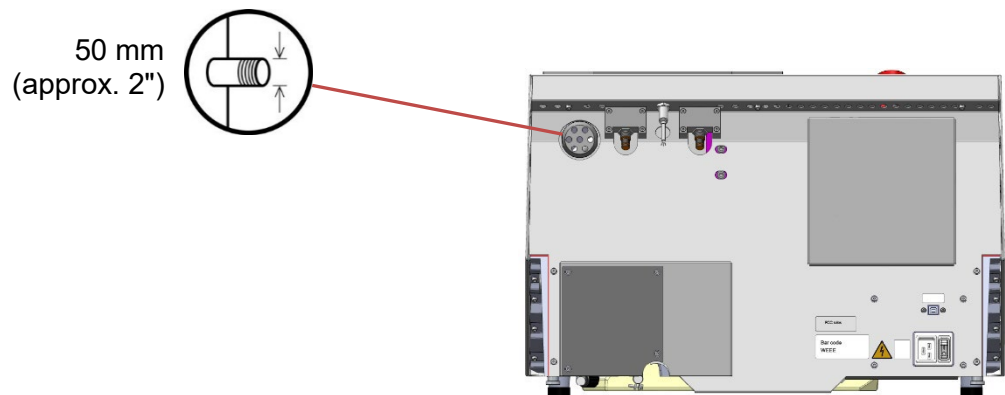

Secotom-6,
Pre-Installation Checklist

Ambient Conditions

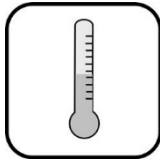

5 - 40 °C
41 - 104 °F



35 - 85 % RH non condensing

Accessories & Consumables

Please refer to the [Secotom Brochure](#) and the [Struers Consumables Catalogue](#) for details of the range available.

Consumables

The use of Struers consumables is recommended.
Other products (e.g. coolants) may contain aggressive solvents, which dissolve e.g. rubber seals. The warranty may not cover damaged machine parts (e.g. seals and tubes), where the damage can be directly related to the use of non-Struers consumables.

Declaration of Conformity

Doc:
16857903 C

Struers ApS
Pederstrupvej 84
DK-2750 Ballerup, Denmark

EU / UE / EL / EC / EE / ES / EÚ / AB

Manufacturer / Производител / Výrobce / Producent / Hersteller / Κατασκευαστής / Fabricante / Tootja / Valmistaja / Fabricant / Proizvodač / Gyártó / Fabricante / Gamintojas / Ražotājs / Fabrikant / Producent / Fabricante / Producătorul / Výrobca / Proizvajalec / Tillverkare / 販売元 / 제조사 / Produzent / Изготовитель / Ímalatçı / 制造商

Декларация за съответствие
Prohlášení o shodě
Overensstemmelseserklæring
Konformitåtserklåring
Δήλωση συμμόρφωσης
Declaración de conformidad
Vastavusdeklaratsioon

Vaatimustenmukaisuusvakuutus
Déclaration de conformité
Izjava o skladnosti
Megfelelőségi nyilatkozat
Dichiarazione di conformità
Atitikties deklaracija
Atbilstības deklarācija

Verklaring van overeenstemming
Deklaracija zgodności
Declaração de conformidade
Declarație de conformitate
Vyhlášení o zhode
Izjava o skladnosti
Intyg om överensstämmelse

適合宣言書
적합성 선언서
Samsvarserklæring
Заявление о соответствии
Uygunluk Beyanı
符合性声明

Name / Име / Název / Navn / Name / Όνομα / Nombre / Nimetus / Nimi / Nom / Naziv / Név / Nome / Pavadinimas / Nosaukums / Naam / Nazwa / Nome / Denumirea / Názov / Ime / Namn / 名前 / 제품명 / Наименование / Adı / 名称 **Secotom-6**

Model / Модел / Model / Model / Modell / Μοντέλο / Modelo / Mudel / Malli / Modèle / Model / Modell / Modello / Modelis / Modelis / Model / Model / Modelo / Modelul / Model / Model / Modell / モデル / 모델 / Modell / Модель / Model / 型号 **Secotom-6**

Function / Функция / Functie / Funktion / Funktion / Λειτουργία / Función / Funktsioon / Toiminto / Fonction / Funkcija / Funkció / Funzione / Funkcija / Funkcija / Functie / Funkcja / Função / Functia / Funkcia / Funkcija / Funktion / 機能 / 기능 / Funksjon / Назначение / Fonksiyon / 功能 **Cut-off machine**

Type / Тип / Typ / Type / Typ / Τύπος / Tipo / Tüüp / Tyyppi / Type / Tip / Tipus / Tipo / Tipos / Tips / Type / Typ / Tipo / Tipul / Typ / Тип / Typ / 種類 / 유형 / Type / Тип / Tür / 类型 **06856127**

Serial no. / Серийн номер / Výrobní číslo / Seriennummer / Seriennummer / Σειριακός αριθμός / N.º de serie / Seerianumber / Sarjainno / No de série / Serijski broj / Sorozatszám / N. seriale / Serijos Nr. / Sērijas Nr. / Serienr. / Numer serijny / N.º de série / Nr. serie / Výrobné č. / Serijska št. / Seriennummer / シリアル番号 / 일련번호 / Serienr. / Серийный номер / Seri no. / 序列号



Module H, according to global approach

en We declare that the product mentioned is in conformity with the following directives and standards:

bg Декларираме, че посоченият продукт е в съответствие със следните директиви и стандарти:

cs Tímto prohlašujeme, že uvedený výrobek je v souladu s následujícími směrnici a normami:

da Vi erklærer herved, at det nævnte produkt er i overensstemmelse med følgende direktiver og standarder:

de Wir erklären, dass das genannte Produkt den folgenden Richtlinien und Normen entspricht:

el Δηλώνουμε ότι το εν λόγω προϊόν είναι σύμφωνο με τις ακόλουθες οδηγίες και πρότυπα:

es Declaramos que el producto mencionado cumple con las siguientes directivas y normativas:

et Kinnitame, et nimetatud toode vastab järgmistele direktiividele ja standarditele:

fi Vakuutamme, että mainuttu tuote on seuraavien direktiivien ja standardien mukainen:

fr Nous déclarons que le produit mentionné est conforme aux directives et normes suivantes :

hr Izjavljujemo da je spomenuti proizvod sukladan sljedećim direktivama i standardima:

hu Kijelentjük, hogy jelen termék megfelel a következő irányelveknek és szabványoknak:

it Dichiariamo che il prodotto citato è conforme ai seguenti standard e direttive:

lt Pareiškiame, kad nurodytas gaminyso atitinka šias direktyvas ir standartus:

lv Mēs apstiprinām, ka minētais produkts atbilst šādām direktīvām un standartiem:

nl Wij verklaren dat het vermelde product in overeenstemming is met de volgende richtlijnen en normen:

pl Oświadczamy, że wymieniony produkt jest zgodny z następującymi dyrektywami i normami:

pt Declaramos que o produto mencionado está em conformidade com as seguintes normas e diretivas:

ro Declărăm cå produsul menționat este în conformitate cu următoarele directive și standarde:

sk Vyhlasujeme, že uvedený výrobok je v súlade s týmito smernicami a normami:

sl Potrjujemo, da je omenjeni izdelek v skladu z naslednjimi direktivami in standardi:

sv Vi intygar att den angivna produkten överensstämmer med följande direktiv och standarder:

ja 弊社はこの指定製品が以下の指令および基準に適合することを宣言します。

ko 해당 선언서 상의 제품은 다음 지침 및 기준에 적합함을 선언합니다.

no Vi erklærer at produktene som er nevnt er i samsvar med følgende direktiver og standarder:

ru Настоящим заявляем, что указанная продукция отвечает требованиям перечисленных далее директив и стандартов:

tr Belirtilen ürünüün aşağıdaki direktiflere ve standartlara uygun olduđunu beyan ederiz:

zh 我们特此声明上述产品符合以下指令和标准:

2006/42/EC EN ISO 12100:2010, EN ISO 13849-1:2015, EN ISO 13849-2:2012, EN ISO 13850:2015, EN ISO 13857:2008, EN ISO 16089:2015, EN 60204-1:2018

2014/30/EU EN 61000-3-2:2014, EN 61000-3-3:2013, EN 61000-6-2:2005/COR:2005, EN 61000-6-3:2007/A1:2011/A1-AC:2012

2011/65/EU
2015/836 EN 63000:2018

1907/2006/EU

Additional standards NFPA 79:2021, FCC 47 CFR part 15 subpart B:2018

Authorized to compile technical file/

Authorized signatory:

Date



Pederstrupvej 84
DK-2750 Ballerup
Denmark