

TenuPol-5

Control unit

Instruction Manual

Original Instructions



CE

Doc. no.: 15397025-01_B_en
Date of release: 2024.02.16

Copyright

The contents of this manual are the property of Struers ApS. Reproduction of any part of this manual without the written permission of Struers ApS is not allowed.

All rights reserved. © Struers ApS.

Table of Contents

1	About this manual	6
1.1	Accessories and consumables	6
2	Safety	6
2.1	Intended use	6
2.2	TenuPol-5 safety precautions	7
2.2.1	Read carefully before use	7
2.3	Safety messages	8
2.4	Safety messages in this manual	9
2.5	Working with electrolytes	12
2.5.1	Perchloric acid	13
3	Get started	16
3.1	Device description	16
3.2	Overview - TenuPol-5	17
3.3	Control panel functions	18
3.4	The display	19
3.4.1	Main menu	21
3.4.2	The process screen	21
3.4.3	The configuration screen	22
4	Transport and storage	23
4.1	Transport	24
4.2	Storage	24
5	Installation	24
5.1	Unpack the machine	24
5.2	Check the packing list	25
5.3	Location	25
5.4	Power supply	26
5.4.1	Power cables	26
5.4.2	Voltage	27
5.5	Preparing the unit for operation	28
5.5.1	Connecting the polishing unit	28
5.5.2	Setting up the polishing unit	28
5.5.3	Filling the container with electrolyte	29
5.5.4	Mounting the jet holders	30
5.6	Noise	30

6 Operate the device	31
6.1 Starting the machine the first time	31
6.2 Methods	31
6.2.1 Struers Methods	32
6.2.2 Selecting a method	38
6.2.3 Creating a method	38
6.2.4 Creating a method not based on Struers methods	39
6.2.5 Renaming a method	43
6.2.6 Changing text	43
6.2.7 Change the settings	44
6.2.8 Resetting a method	46
6.3 Electrolytic preparation	47
6.3.1 Preparing a specimen for pre-thinning	47
6.3.2 Pre-thinning the specimen	48
6.3.3 Blanking/Punching	48
6.3.4 Placing a specimen in the specimen holder	49
6.3.5 Starting the thinning process	49
6.3.6 Post-treatment of the specimen	50
6.3.7 Final thinning	50
6.3.8 Stopping the thinning process	51
6.3.9 Emptying the electrolyte container	51
6.3.10 Cleaning the polishing cell	52
6.4 Optimizing the results	52
6.4.1 Electrolytes	52
6.4.2 Flow rate	53
6.4.3 Temperature	53
6.4.4 Electrical conditions	53
6.4.5 Polishing defects	53
6.4.6 The hole is too big	54
7 Maintenance and service	54
7.1 Manual functions	55
7.1.1 Changing electrolyte	55
7.1.2 Cleaning	57
7.1.3 Operating the pump manually	58
7.2 Daily	58
7.2.1 Control unit	59
7.3 Weekly	59
7.4 Monthly	60
7.4.1 Calibrating the pump	60

7.5	Annually	61
7.5.1	Test the safety devices	62
7.6	Spare parts	62
7.7	Service and repair	62
7.8	Disposal	63
8	Troubleshooting	63
9	Technical data	64
9.1	Technical data - TenuPol-5	64
9.2	Noise and vibration levels	64
9.3	Safety Circuit Categories/Performance Level	64
9.4	Safety Related Parts of the Control System (SRP/CS)	65
9.5	Diagrams	65
9.5.1	Diagrams - TenuPol-5	66
9.6	Legal and regulatory information	69
10	Manufacturer	69
	Declaration of Conformity	71

1 About this manual

**CAUTION**

Struers equipment must only be used in connection with and as described in the Instruction Manual supplied with the equipment.

**Note**

Read the Instruction Manual carefully before use.

**Note**

If you want to view specific information in detail, see the online version of this manual.

1.1 Accessories and consumables

Accessories

For information about the available range, see the TenuPol-5 brochure:

- [The Struers Website](http://www.struers.com) (<http://www.struers.com>)

Consumables

The machine is designed to be used only with Struers consumables specifically designed for this purpose and this type of machine.

Other products may contain aggressive solvents, which dissolve e.g. rubber seals. The warranty may not cover damaged machine parts (e.g. seals and tubes), where the damage can be directly related to the use of consumables not supplied by Struers.

For information about the available range, see: [The Struers Website](http://www.struers.com) (<http://www.struers.com>).

2 Safety

2.1 Intended use

The unit is intended to be used in combination with:

- TenuPol-5 Polishing unit

The machine is for use in a professional working environment (e.g. a materialographic laboratory).

TenuPol-5 is designed to perform automatic electrolytic thinning of specimens.

The equipment is intended for use in quality control applications, where the surface can be prepared for further materialographic inspection with a transmitted electron microscope (TEM).

The equipment is designed for preparation of conductive materials suitable for electrolytic etching.

In order for the equipment to operate correctly and safely, it must be used with Struers accessories and consumables specially designed for this purpose and this type of device.

When in use, the machine equipment must not be touched, moved or tampered with.

The operator must be fully instructed in how to handle and use electrolytes with this machine.

The machine must be operated only by skilled/trained personnel.

The machine must be connected to a cooling unit in order to function as intended.

Do not use the machine for the following	<p>Preparation of materials other than materials suitable for materialographic studies.</p> <p>The machine must not be used for any type of explosive and/or flammable material, or materials which are not stable during machining, heating or pressure.</p> <p>Do not use the machine without sufficient ventilation.</p> <p>The machine must not be used with consumables or a combination of electrolytes and accessories which are not compatible for use with this equipment.</p>
Model	TenuPol-5

Polishing unit

See the Instruction Manual for this unit.

2.2 TenuPol-5 safety precautions

2.2.1 Read carefully before use

1. Ignoring this information and mishandling of the equipment can lead to severe bodily injuries and material damage.
2. The machine must be installed in compliance with local safety regulations. All functions on the machine and any connected equipment must be in working order. The machine must be earthed (grounded).
3. The operator must read the safety precautions and Instruction Manual, as well as relevant sections of the manuals for any connected equipment and accessories.
4. The operator must be fully instructed in how to handle and use electrolytes with this machine.
5. Follow all safety requirements for handling, mixing, emptying and disposing of electrolytes.
6. The machine must be placed in a well-ventilated location. If needed, you can also place it in a fume cabinet.
7. The machine must be placed on a safe and stable table with an adequate working height.
8. The device is designed to be used with Struers consumables specially designed for this purpose and this type of device.

9. The machine is designed to be used with electrolytes recommended by Struers. Electrolytes that are not recommended by Struers can be dangerous to the operator or harm the machine.
10. Danger of chemical burns. Follow all safety requirements for handling, mixing, emptying and disposing of electrolytes.
11. Many electrolytes contain alcohol or other flammable solvents. Always follow all safety precautions when working with these types of electrolyte.
12. Never try to open the polishing unit while it is running.
13. Do not use the pump without having electrolyte or water in the electrolyte container.
14. Struers recommends that the cooling water supply is shut off or disconnected if the machine is to be left unattended.
15. Always use goggles, gloves and other recommended protective clothing.
16. Accessories: Only use accessories specifically developed for use with this type of machine.
17. If you observe malfunctions or hear unusual noises, switch off the machine and call technical service.
18. Always switch off the electrical power supply and remove the plug or power cable before dismantling the machine or installing additional components.
19. Make sure that the actual electrical power supply voltage corresponds to the voltage stated on the type plate of the machine.
20. The machine must be disconnected from the electrical power supply before any service. Wait 5 minutes until residual potential on the capacitors is discharged.
21. Struers equipment must only be used in connection with and as described in the Instruction Manual supplied with the equipment.
22. If the equipment is subjected to misuse, incorrect installation, alteration, neglect, accident or incorrect repair, Struers will accept no responsibility for damage to the user or the equipment.
23. Dismantling of any part of the equipment, during service or repair, should always be performed by a qualified technician (electromechanical, electronic, mechanical, pneumatic, etc.).

2.3 Safety messages

Struers uses the following signs to indicate potential hazards.



ELECTRICAL HAZARD

This sign indicates an electrical hazard which, if not avoided, will result in death or serious injury.



DANGER

This sign indicates a hazard with a high level of risk which, if not avoided, will result in death or serious injury.



WARNING

This sign indicates a hazard with a medium level of risk which, if not avoided, could result in death or serious injury.

**CAUTION**

This sign indicates a hazard with a low level of risk which, if not avoided, could result in minor or moderate injury.

**CRUSHING HAZARD**

This sign indicates a crushing hazard which, if not avoided, could result in minor, moderate or serious injury.

**HEAT HAZARD**

This sign indicates a heat hazard which, if not avoided, can result in minor, moderate or serious injury.

**Emergency stop**

Emergency stop

General messages**Note**

This sign indicates that there is a risk of damage to property, or a need to proceed with special care.

**Hint**

This sign indicates that additional information and hints are available.

2.4 Safety messages in this manual**WARNING**

Struers equipment must only be used in connection with and as described in the Instruction Manual supplied with the equipment.

**WARNING**

Follow all safety requirements for handling, mixing, emptying and disposing of electrolytes.

**WARNING**

Danger of chemical burns.
Follow all safety requirements for handling, mixing, emptying and disposing of electrolytes.

**CAUTION**

Always request and read the Safety Data Sheet for each electrolyte before you start working with it.

**CAUTION**

Many electrolytes contain alcohol or other flammable solvents. Always follow all safety precautions when working with these types of electrolyte.

**CAUTION**

The operator must be fully instructed in how to handle and use electrolytes with this machine.

**CAUTION**

The machine is designed to be used with electrolytes recommended by Struers. Electrolytes that are not recommended by Struers can be dangerous to the operator or harm the machine.

**CAUTION****Fire and explosion hazards**

- 60% perchloric acid is a very corrosive and oxidizing product. Heating it can cause an explosion, and contact with combustible materials can cause fire.
- Fire fighting must be carried out from a protected location. Use extinguishing media as specified in the Safety Data Sheet.

**CAUTION**

All persons involved in mixing, using, storing, transporting, and disposing of electrolytes must be trained in how to handle perchloric acid when carrying out these tasks.

- Do not inhale any vapor from the solution or its components.
- Avoid skin contact.

**WARNING**

Always wear a full-face shield or splash goggles, rubber gloves and a laboratory coat or coveralls when you are working with perchloric acid.

**WARNING**

Make sure that you are mixing the solvent in a chemical-fume hood designed for perchloric acid use.

**WARNING**

Do not use combustible or carbonaceous containers, reaction vessels, spill pans, storage shelves or similar materials when you work with perchloric acid.

**CAUTION**

Do not produce anhydrous perchloric acid, either from its salts or from aqueous solutions, e.g. by heating with high boiling acids or dehydrating agents such as sulfuric acid or phosphorous pentoxide. In addition to spontaneous explosion, the anhydrous acid explodes instantaneously on contact with oxidizable organic materials.

**CAUTION**

Limit the use or storage of perchloric acid to quantities less than 500 g per fume hood.

**CAUTION**

Never turn the polishing unit upside down, particularly if there is electrolyte in the pump.

**CRUSHING HAZARD**

Take care of your fingers when handling the machine.

**ELECTRICAL HAZARD**

The machine must be earthed (grounded).
Switch off the electrical power supply before installing electrical equipment.
Make sure that the actual electrical power supply voltage corresponds to the voltage stated on the type plate of the machine.
Incorrect voltage can damage the electrical circuit.

**ELECTRICAL HAZARD****For electrical installations with Residual Current Circuit Breakers**

For this machine a residual current circuit breaker Type B, 30 mA (or better) is recommended is required (EN 50178/5.2.11.1).

For electrical installations without Residual Current Circuit Breakers

The equipment must be protected by an insulation transformer (double-wound transformer).

Contact a qualified electrician to verify the solution.

Always follow local regulations.

**CAUTION**

Prolonged exposure to loud noises may cause permanent damage to a person's hearing.
Use hearing protection if the exposure to noise exceeds the levels set by local regulations.

**CAUTION**

Do not use the machine with non-compatible accessories or consumables.

**CAUTION**

Always use goggles or a protective shield, and chemical-resistant gloves.

**WARNING**

Do not touch, move or tamper with the unit during use.



WARNING

Do not use the machine with defective safety devices.
Contact Struers Service.



WARNING

Safety critical components must be replaced after a maximum lifetime of 20 years.
Contact Struers Service.



CRUSHING HAZARD

Take care of your fingers when handling the machine.
Wear safety shoes when handling heavy machinery.

2.5 Working with electrolytes



WARNING

Danger of chemical burns.
Follow all safety requirements for handling, mixing, emptying and disposing of electrolytes.



CAUTION

Always request and read the Safety Data Sheet for each electrolyte before you start working with it.



CAUTION

Many electrolytes contain alcohol or other flammable solvents. Always follow all safety precautions when working with these types of electrolyte.



CAUTION

The operator must be fully instructed in how to handle and use electrolytes with this machine.



CAUTION

The machine is designed to be used with electrolytes recommended by Struers. Electrolytes that are not recommended by Struers can be dangerous to the operator or harm the machine.



CAUTION

Many electrolytes contain alcohol or other flammable solvents. Make sure that all safety precautions are followed for these types of electrolytes.

Availability

Struers electrolytes are not marketed in the USA. If needed, the chemical compounds for the electrolyte must be purchased independently.

Contact your Struers representative for further information.

After use

Do not let the electrolyte dry or crystallize inside the machine or on the polished material.

Disposal

See [Disposal](#) ► 63.

2.5.1 Perchloric acid

**CAUTION**

Always request and read the Safety Data Sheet for each electrolyte before you start working with it.

To find the Safety Data Sheet for the components in question, see: www.struers.com.

**CAUTION****Fire and explosion hazards**

- 60% perchloric acid is a very corrosive and oxidizing product. Heating it can cause an explosion, and contact with combustible materials can cause fire.
- Fire fighting must be carried out from a protected location. Use extinguishing media as specified in the Safety Data Sheet.

Training

**CAUTION**

All persons involved in mixing, using, storing, transporting, and disposing of electrolytes must be trained in how to handle perchloric acid when carrying out these tasks.

- Do not inhale any vapor from the solution or its components.
- Avoid skin contact.

Mixing perchloric acid into the electrolyte solution

If you are working with Struers electrolytes marked with the prefix A, you must mix a certain amount of perchloric acid into the electrolyte solution.

**WARNING**

Always wear a full-face shield or splash goggles, rubber gloves and a laboratory coat or coveralls when you are working with perchloric acid.

**WARNING**

Make sure that you are mixing the solvent in a chemical-fume hood designed for perchloric acid use.

**WARNING**

Do not use combustible or carbonaceous containers, reaction vessels, spill pans, storage shelves or similar materials when you work with perchloric acid.

**WARNING**

For information about electrolytes, see the Safety Data Sheet for the specific product.

Procedure**CAUTION**

The components must be used in the correct quantity as specified below.

Electrolyte A2		
<ol style="list-style-type: none"> Mix ethanol, butoxyethanol and water. Immediately before use, add A2 II - perchloric acid to the A2 I mixture. 		
Formula	A2 I	A2 II
	90 ml distilled water 730 ml ethanol 100 ml butoxyethanol	78 ml perchloric acid
Chemicals	All chemicals are chemically pure, preferably analytical grade. Per cent is, where no other is stated, weight per cent.	
	Butoxyethanol	Ethylene glycol monobutyl ether, CH ₃ -(CH ₂) ₂ -CH ₂ -O-CH ₂ -CH ₂ OH
	Ethanol 96% vol	CH ₃ -CH ₂ OH
	Perchloric acid	60%, HClO ₄
	Distilled water	H ₂ O
Health and Safety		
<p>Before mixing, read the MSDS thoroughly for the specific components.</p> <p>The user must follow the instructions for proper work procedure according to the instruction manual supplied with the equipment.</p>		
<div style="border: 1px solid black; padding: 5px;">  <p>Note The product must be disposed of according to local regulations for dangerous goods.</p> </div>		

Electrolyte A3		
<ol style="list-style-type: none"> Mix ethanol and butoxyethanol. Immediately before use, add A3 II - perchloric acid to the A3 I mixture. 		
Formula	A3 I	A3 II
	600 ml methanol	60 ml perchloric acid
	360 ml butoxyethanol	

Electrolyte A3							
Chemicals	All chemicals are chemically pure, preferably analytical grade. Per cent is, where no other is stated, weight per cent.						
	<table border="1"> <tr> <td>Butoxyethanol</td> <td>Ethylene glycol monobutyl ether, $\text{CH}_3\text{-(CH}_2\text{)}_2\text{-CH}_2\text{-O-CH}_2\text{-CH}_2\text{OH}$</td> </tr> <tr> <td>Methanol</td> <td>100% vol., CH_3OH</td> </tr> <tr> <td>Perchloric acid</td> <td>60%, HClO_4</td> </tr> </table>	Butoxyethanol	Ethylene glycol monobutyl ether, $\text{CH}_3\text{-(CH}_2\text{)}_2\text{-CH}_2\text{-O-CH}_2\text{-CH}_2\text{OH}$	Methanol	100% vol., CH_3OH	Perchloric acid	60%, HClO_4
	Butoxyethanol	Ethylene glycol monobutyl ether, $\text{CH}_3\text{-(CH}_2\text{)}_2\text{-CH}_2\text{-O-CH}_2\text{-CH}_2\text{OH}$					
	Methanol	100% vol., CH_3OH					
Perchloric acid	60%, HClO_4						
Health and Safety							
Before mixing, read the MSDS thoroughly for the specific components.							
The user must follow the instructions for proper work procedure according to the instruction manual supplied with the equipment.							
<div style="border: 1px solid blue; border-radius: 10px; padding: 10px;">  <p>Note The product must be disposed of according to local regulations for dangerous goods.</p> </div>							

Electrolyte D2		
1. Mix the phosphoric acid in the distilled water		
2. Add ethanol, propanol and urea.		
Formula	D2	
	500 ml distilled water	
	250 ml phosphoric acid	
	250 ml ethanol	
	50 ml propanol	
	5 g urea	
Chemicals	All chemicals are chemically pure, preferably analytical grade. Per cent is, where no other is stated, weight per cent.	
	Ethanol	96% vol., $\text{CH}_3\text{-CH}_2\text{OH}$
	Phosphoric acid	Ortho phosphoric acid 85%, $(\text{HO})_3\text{PO}$
	Propanol	2-propanol 100%, $\text{CH}_3\text{-CH}_2\text{-CH}_2\text{OH}$
	Urea	$\text{CO}(\text{NH}_2)_2$
	Distilled water	H_2O

Electrolyte D2**Health and Safety**

Before mixing, read the MSDS thoroughly for the specific components.

The user must follow the instructions for proper work procedure according to the instruction manual supplied with the equipment.

**Note**

The product must be disposed of according to local regulations for dangerous goods.

Storing perchloric acid or solution**CAUTION**

Do not produce anhydrous perchloric acid, either from its salts or from aqueous solutions, e.g. by heating with high boiling acids or dehydrating agents such as sulfuric acid or phosphorous pentoxide. In addition to spontaneous explosion, the anhydrous acid explodes instantaneously on contact with oxidizable organic materials.

**CAUTION**

Limit the use or storage of perchloric acid to quantities less than 500 g per fume hood.

3. Never let perchloric acid crystallize on bottle necks, caps or anywhere else.
4. Store the chemical in a secure, cool, and well-ventilated area with a metal, glass or ceramic spill catch pan.
5. Store the chemical away from other chemicals or combustible or organic materials.
6. Never let solutions dry out.

For more information, see the Safety Data Sheet for the product.

3 Get started

3.1 Device description

The equipment is used for materialographic preparation which enables further examination of materials for quality control purposes. It is designed for fast preparation of specimens suitable for transmission electron microscopy (TEM).

Electrolytical thinning can be performed on most metallic material surfaces. The electrochemical process is possible on electrically conductive materials by the action of electrolyte and electricity. During the process, a high, local current, which is applied to the area of the specimen covered with electrolytes, will have an etching effect on the surface. This process makes the surface suitable for further materialographic analysis.

The equipment consists of a control unit and a polishing unit.

The polishing unit must be placed in a well ventilated area, preferably a fume cabinet, to prevent inhalation of hazardous vapors.

The operator fills and empties the electrolyte container in the polishing unit.

Before starting the process, the operator places a specimen/sample/workpiece in the specimen holder/sample holder. The operator selects a suitable method, accessory, and electrolyte. There are 200 predefined polishing/thinning methods for pre-thinning and final thinning.

The operator makes sure that a suitable combination of electrolytes and polishing parameters is selected for the material. The operator makes sure that the correct electrolyte is in the polishing unit.

The operator starts the process. A scanning function automatically determines the correct polishing voltage for the thinning process. Small layers of material are removed from both sides of the specimen in the electrolytic etching/thinning process. During the process, current and electrolyte temperature are shown on the screen.

The voltage and current are monitored and adjusted automatically. In case of excess heat and/or excess power consumption the unit switches off automatically.

The polishing/thinning process stops automatically when a hole appears in the specimen.

After use, the electrolyte container must be emptied and cleaned with water. The electrolyte must be stored in a safe location in a closed container suitable for the purpose. Cleaning is carried out by using the electrolyte container filled with water.

**Note**

Proper maintenance is required to achieve the maximum up-time and operating lifetime of the machine.

**Note**

The device is designed to be used with Struers consumables specially designed for this purpose and this type of device.

3.2 Overview - TenuPol-5

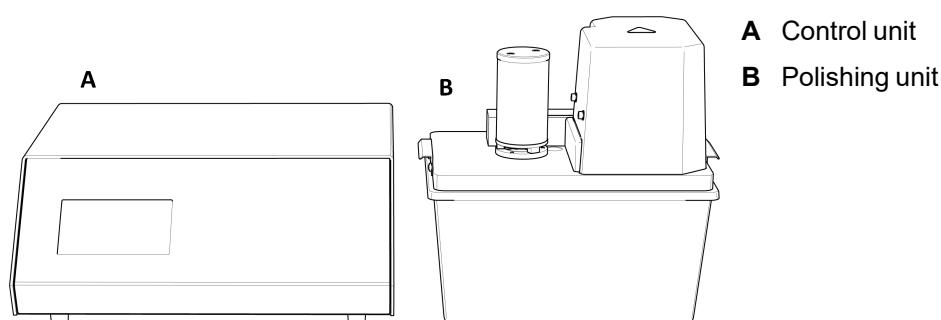

Control unit

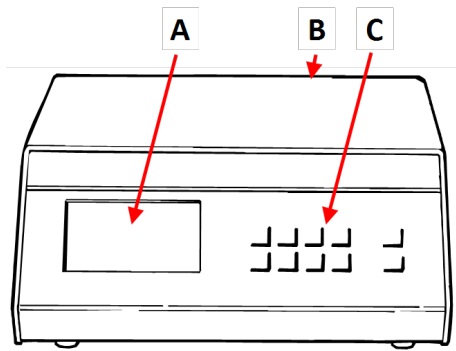

Front view - Control unit

- A Display
- B Main switch (on the rear side)
- C Control panel

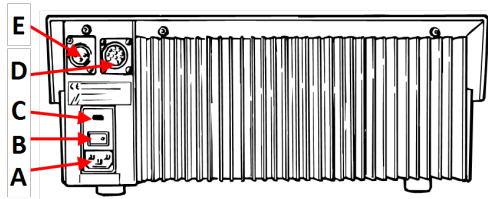

Rear view - Control unit

- A Socket - Power supply
- B Main switch
- C Fuse compartment
- D Socket - Polishing unit
- E Socket - Electronic thermo sensor







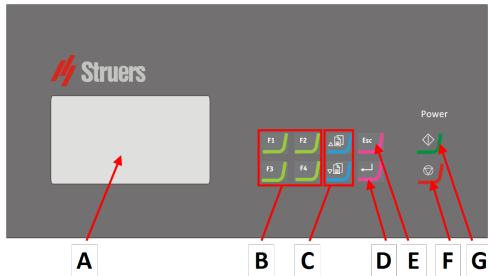

Polishing unit

See the manual supplied with the specific equipment.

3.3 Control panel functions



- A Display
- B Function keys - F1 to F4
- C Scroll up/Scroll down
- D Select/Enter
- E Escape
- F Stop
- G Start

Button	Function
 to 	Function key <ul style="list-style-type: none"> Press this button to activate controls for various purposes. See the bottom line of the individual screens.
	Scroll up <ul style="list-style-type: none"> Press this button to scroll up in a screen and to increase the value of a setting.
	Scroll down <ul style="list-style-type: none"> Press this button to scroll down in a screen and to decrease the value of a setting.
	Escape Use this button on the control panel to return to previous functions or values. <ul style="list-style-type: none"> Press the button to return to the main menu. Press the button to return to the last function or value. Press the button to cancel changes.
	Select/Enter <ul style="list-style-type: none"> Press this button to enter a field, for instance a setting, to select a value, and to confirm a selection.
	Start <ul style="list-style-type: none"> Starts the thinning process.
	Stop <ul style="list-style-type: none"> Stops the thinning process.

3.4 The display



Note

The screens shown in this manual may differ from the actual screens in the software.

When you switch on the machine, the display shows the configuration and the version of the installed software.

After start-up, the display changes to the screen last shown when the machine was switched off.

The display is divided into some main areas. See this example.

A Title bar

The title bar shows the function you have selected.

B Information fields

These fields show information about the selected function. In some fields you can select and change the value.

C Function key options

The functions shown depend on the screen that is displayed.

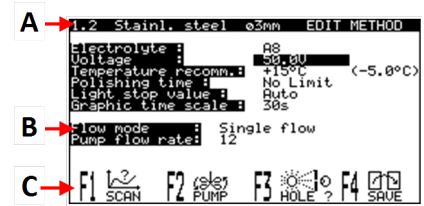

The display shows information such as menus, preparation settings, or the preparation process as it progresses.

Navigating in the display

Use the buttons on the control panel to navigate in the display.

See [Control panel functions](#) ► 18.

Sound	Description
Short beep	A short beep, when you press a key, indicates that the selection is confirmed. You can enable or disable the beep: select Configuration .
Long beep	A long beep, when you press a button, indicates that the key cannot be activated at the moment. You cannot disable this beep.

Standby mode



To increase the lifetime of the display, the backlight is dimmed automatically if the machine has not been used for a while. (30 min)

- Press any key to reactivate the display.

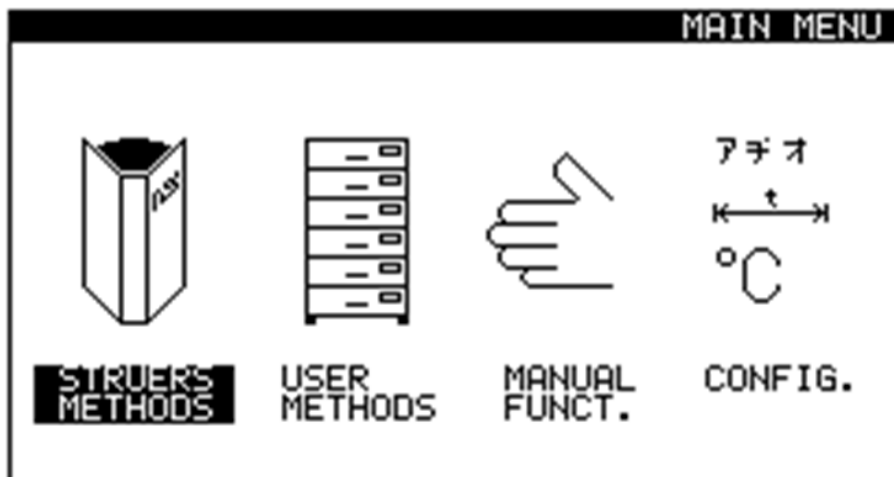
3.4.1 Main menu

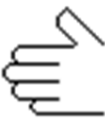
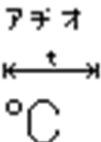

From the **Main menu** screen you can choose between the following options:

- 
 - **Struers Methods**
- 
 - **User Methods**
- 
 - **Manual funct.**
- 
 - **Config.**

See

- [Methods ▶ 31](#)
- [Manual functions ▶ 55](#)
- [The configuration screen ▶ 22](#)

3.4.2 The process screen

This is an example showing the process screen.

- A Current-time graph
- B Process status. Example: **Process running**
- C Electrolyte temperature

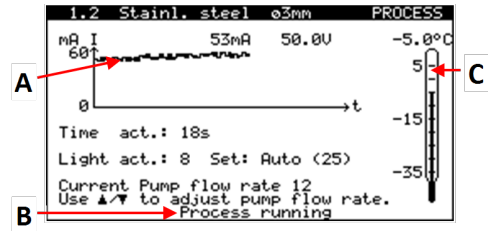

3.4.3 The configuration screen

You can change general settings in the **Configuration** menu.

1. From the **Main menu** screen, select **Config..**
2. From the **Configuration** screen, select:
 - **Display contrast**
 - **Language**
 - **Temperature unit**
 - **Temp. warning**
 - **Max. Temperature**
 - **Pump pre-time**

Menu item	Description
Display contrast	<ul style="list-style-type: none"> • If needed, adjust the contrast settings of the display.
Language	<ul style="list-style-type: none"> • Select the language you wish to use. If needed, you can change the language at a later date.
Temperature unit	<ul style="list-style-type: none"> • Set the temperature unit to be used: Celsius or Fahrenheit.
Temp. warning	<ul style="list-style-type: none"> • Set the temperature level for each method, if needed. When the pre-set temperature is reached, cooling of the electrolyte starts. A temperature warning indicates that the electrolyte temperature has exceeded the temperature set in the method. - 0 - 10°C (32 - 50°F) or - No Warning
Max. Temperature	<ul style="list-style-type: none"> • Set the maximum temperature of the electrolyte, if needed. If this value is reached during the process, the machine stops automatically. 30 - 50°C (86 - 122°F)

Menu item	Description
Pump pre-time	<ul style="list-style-type: none"> Set the time when the pump must start running before the current is applied. This is used to achieve an even flow of electrolyte from the very start of the process. <ul style="list-style-type: none"> 4 - 15 s
F1 - Def. value	<ul style="list-style-type: none"> If needed, reset values to the default factory setting: <ul style="list-style-type: none"> Select the relevant value. Press F1.
F2 - Elect. Formula	View formulas and mixing conditions for all Struers electrolytes.
F3 - Edit Elect. Name	<p>If you are using your own electrolytes, you can change the names to names of your own choice.</p> <div style="border: 1px solid blue; border-radius: 10px; padding: 10px; margin: 10px 0;"> <p>Note  When you change the name of a user defined electrolyte, the name changes automatically in all the methods where this electrolyte is used.</p> </div> <ol style="list-style-type: none"> Select the electrolyte. Press F3 to start the editing function. Select the name. Enter the new name. <p>See Renaming a method ▶ 43.</p>
F4 - Adj. Pump	<ul style="list-style-type: none"> The pump must be adjusted before it is used for the first time. Use this function to check the pump regularly. <p>See Calibrating the pump ▶ 60.</p>

4 Transport and storage

If, at any time after the installation, you have to move the unit or place it in storage, there is a number of guidelines we recommend that you follow.

- Package the unit securely before transportation. Insufficient packaging could cause damage to the unit and will void the warranty. Contact Struers Service.
- We recommend that you use the original packaging and fittings.

4.1 Transport

1. Clean the control unit with a soft, damp cloth.
2. Clean the polishing unit thoroughly. See the Instruction Manual for this unit.
3. Disconnect the electrical power supply.
4. Disconnect the polishing unit from the water supply or the cooling unit (option).
5. Move the units to their new positions.

4.2 Storage



Note

We recommend that you keep all original packaging and fittings for future use.

- Disconnect the unit from the electrical power supply.
- Remove any accessories.
- Clean and dry the unit before storage. See [Daily ▶ 58](#).
- Place the machine and accessories in their original packaging.
- Place a bag of desiccant (silica gel) in the box.
- For details on storage temperature and humidity, see [Technical data - TenuPol-5 ▶ 64](#).

Polishing unit

See the Instruction Manual for this unit.

5 Installation

5.1 Unpack the machine



Note

We recommend that you keep all original packaging and fittings for future use.

The equipment is delivered in two boxes.

- Control unit
- Polishing unit

Control unit

1. Cut the packing tape on the top of the box.
2. Remove the loose parts.

- Remove the unit from the box.

Polishing unit

See the Instruction Manual for this unit.

Moving the machine

See [Transport ▶ 24](#).

5.2 Check the packing list

The equipment is delivered in two boxes.

- Control unit
- Polishing unit

Optional accessories may be included in the packing box.

Control unit

The packing box contains the following items:

Pcs.	Description
1	Control unit
2	Electrical power supply cables
1	Connection adapter
1	Electronic thermo sensor, +35 to -50°C (95 to -58°F)
1	Instruction Manual set

Polishing unit

See the Instruction Manual for this unit.

5.3 Location



CRUSHING HAZARD

Take care of your fingers when handling the machine.
Wear safety shoes when handling heavy machinery.

Control unit

- Place the unit on a rigid, stable workbench with a horizontal surface and an adequate height.
- Place the unit close to the fume cabinet where the polishing unit is placed.



Note

Do not place the control unit in a fume cabinet as the sensitive electronics can be damaged by chemical fumes from the electrolytes.

Polishing unit

See the Instruction Manual for this unit.

5.4 Power supply



CAUTION

The machine must be earthed (grounded).
 Switch off the electrical power supply before installing electrical equipment.
 Make sure that the actual electrical power supply voltage corresponds to the voltage stated on the type plate of the machine.
 Incorrect voltage can damage the electrical circuit.

Power socket

The electrical power supply socket must be easy to access.

The electrical power supply socket must be located at a height ranging from 0.6 m to 1.9 m (2½' to 6') above floor level. Not higher than 1.7 m (5' 6") is recommended.

5.4.1 Power cables



ELECTRICAL HAZARD

The machine must be earthed (grounded).
 Switch off the electrical power supply before installing electrical equipment.
 Make sure that the actual electrical power supply voltage corresponds to the voltage stated on the type plate of the machine.
 Incorrect voltage can damage the electrical circuit.



Note

The equipment is shipped with 2 types of electrical power cables. If the plug supplied on these cables is not approved in your country, the plug must be replaced with an approved plug.

Single-phase supply

The 2-pin plug (European Schuko) is for use on single-phase electrical power connections.



The leads must be connected as follows:

Yellow/Green	Earth (ground)
Brown	Line (live)
Blue	Neutral

2-phase supply

The 3-pin plug (North American NEMA) is for use on 2-phase electrical power connections.

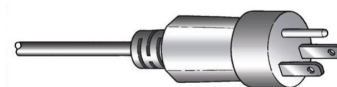

The leads must be connected as follows:

Green	Earth (ground)
Black	Neutral
White	Line (live)

Connection to the machine

- Connect the electrical power cable to the socket at the back of the control unit.
- Connect the cable to the electrical power supply.



5.4.2 Voltage



CAUTION

The machine must be earthed (grounded).
Switch off the electrical power supply before installing electrical equipment.
Make sure that the actual electrical power supply voltage corresponds to the voltage stated on the type plate of the machine.
Incorrect voltage can damage the electrical circuit.



Note

In countries with a 100 - 120 V electrical power supply, you must change the setting of the equipment.

- 115 V: 100-120 V/50/60 Hz
- 230 V: 200-240 V/50/60 Hz Factory setting

How to change the voltage

1. Use a small, flat-tip screwdriver to open the cover of the fuse compartment at the back of the control unit.
2. Take the fuse holder out of the fuse compartment.
3. Turn the fuse holder into the required position.
4. Push it back into the fuse compartment.
5. Close the cover of the fuse compartment. The "window" should now show the correct voltage.

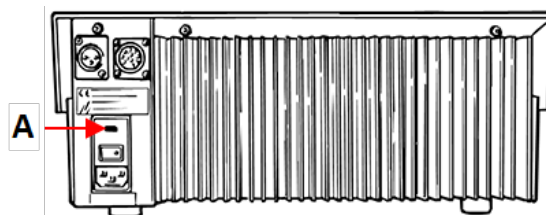

A Fuse compartment

5.5 Preparing the unit for operation



WARNING

The polishing unit must be placed in a well ventilated area, preferably a fume cabinet. Do not touch, move or tamper with the unit during use.

5.5.1 Connecting the polishing unit



WARNING

The polishing unit must be placed in a well ventilated area, preferably a fume cabinet. Do not touch, move or tamper with the unit during use.

1. Connect the cable from the polishing unit to the adapter supplied with the control unit.
2. Connect the adapter cable to the back of the control unit.
3. Tighten the retaining ring to secure the plug.

Calibrating the pump

The first time the machine is switched on, it is recommended that you adjust the pump. See [Calibrating the pump ▶ 60](#).

5.5.2 Setting up the polishing unit

1. Place the base plate with pump and cooling coil on the insulated container.
2. Insert the thermo sensor, **A**, in the hole between the polishing cell and the pump motor.



CAUTION

Always use the thermo sensor during preparation.

3. Connect one of the tubes supplied with the polishing unit to the cooling coil and to the cooling water supply.

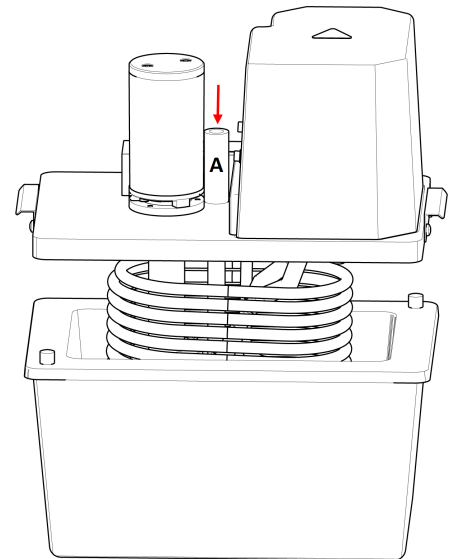

4. Connect the other tube to the other side of the cooling coil and lead it to the drain.
5. If the unit is connected to an external cooling unit (option), use suitable, insulated tubes to connect the cooling unit and the cooling coil.



Note

See the Instruction Manual for this unit.

**Hint**

If it is not possible to cool the electrolyte with cooling water or an external cooling unit, place the uninsulated container in an ice bath for cooling.

5.5.3 Filling the container with electrolyte**CAUTION**

Always observe the current safety regulations regarding handling and disposal of electrolytes.

The operator must be fully instructed in how to handle and use electrolytes with this machine.

**WARNING**

Always handle electrolytes in well ventilated areas.

Always use safety gloves, goggles and a funnel when you handle electrolytes.

For instructions on handling electrolytes, see [Working with electrolytes](#) ► 12.

1. Remove the base plate with the pump and cooling coil from the electrolyte container.
2. Fill the electrolyte container to the mark with electrolyte (approximately 1 l).
3. Place the base plate on the electrolyte container.

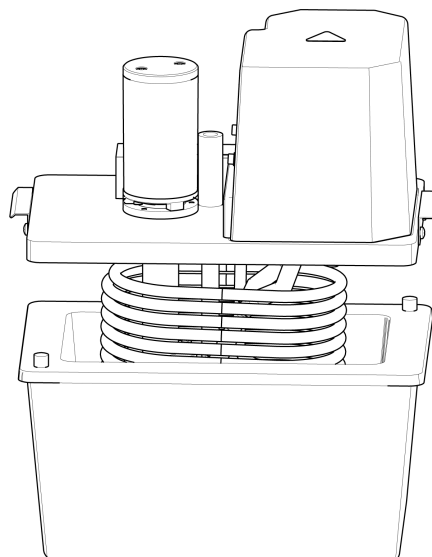

5.5.4 Mounting the jet holders

1. Place one jet holder in the polishing chamber and slide the sleeve into the groove until the holder fits tightly against the back wall of the chamber.
2. Mount the other jet in the same way at the other side of the chamber.

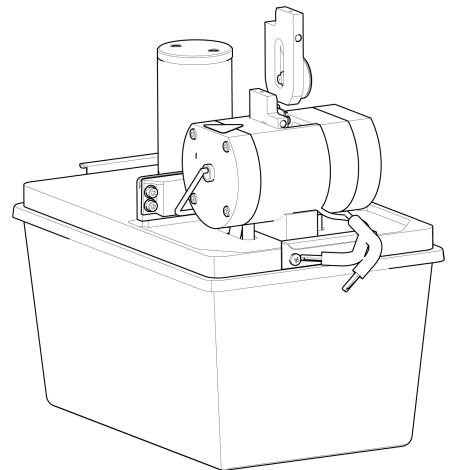

3. Connect the two mini jack plugs in the corresponding sockets in the jet holders.

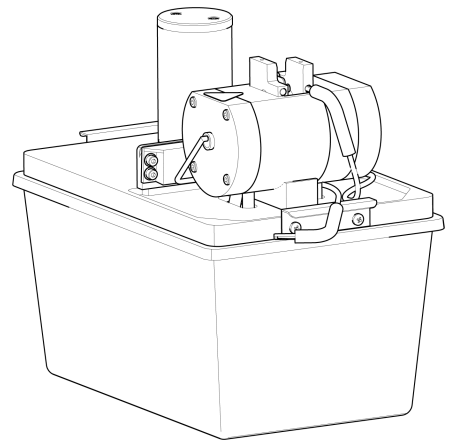

4. Place the protective cover over the polishing chamber.

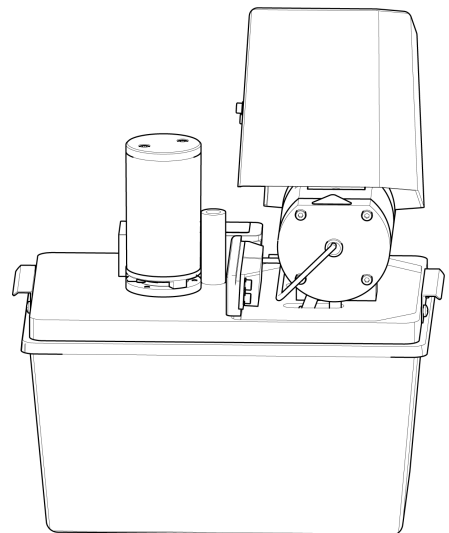

5.6 Noise

For information on the sound pressure level value, see this section: [Technical data ▶ 64](#)

**CAUTION**

Prolonged exposure to loud noises may cause permanent damage to a person's hearing.
Use hearing protection if the exposure to noise exceeds the levels set by local regulations.

6 Operate the device

6.1 Starting the machine the first time

- Switch on the machine on the main switch at the back of the control unit.

Start-up - the first time

The first time the machine is switched on, the **Main menu** screen is shown.

For instructions on how to navigate in the display, see:

- [Control panel functions ▶ 18](#)
- [The display ▶ 19](#)

Language

Select the language you wish to use. If needed, you can change the language at a later date.

1. From the **Main menu** screen, select **Config. > Language**.
2. Scroll up or down in the list to select the language of your choice.

Calibrating the pump

The pump must be adjusted before it is used for the first time.

This function calibrates the pump of the polishing unit and ensures that the flow rate settings in the Struers methods are correct.

See [Calibrating the pump ▶ 60](#).

Start-up - daily operation

When you switch on the machine, the screen that was shown when the machine was switched off is shown just after the start-up screen.

6.2 Methods

You can work with the following types of methods:

- **Struers Methods**

These methods are predefined. You cannot change the settings. If needed, copy them into the **User Methods** folder, and change the settings.

- **User Methods**

These methods you can copy and change as needed.

Preparing the specimens for electrolytic polishing and etching

The specimens must be ground before you can carry out electrolytic polishing and etching. The finer the surface finish is, the shorter the polishing time is, and this usually gives a better final result.

Details on mechanical specimen preparation can be found here:

- [The Struers Website](http://www.struers.com) (http://www.struers.com)

6.2.1 Struers Methods

Pre-thinning and blanking

There are 8 preset methods for pre-thinning and blanking. They are shown with a 10 mm diameter and a small clock symbol next to the electrolyte name.

Select the method you wish to use.

Methods

0.1 Stainless steel Ø10 mm		
Electrolyte	A8	
Voltage	90 V	
Temperature recomm.	+15°C (+19.8°C)	
Polishing time	3 m 0 s	
Light stop value	Ignore	
Graphic time scale	Auto	
Flow mode	Single flow	
Pump flow rate	19	

0.3 Low C steel Ø10 mm		
Electrolyte	A2	
Voltage	40 V	
Temperature recomm.	+5°C (+19.8 °C)	
Polishing time	3 m 0 s	
Light stop value	Ignore	
Graphic time scale	Auto	
Flow mode	Single flow	
Pump flow rate	23	

0.6 Impax 45HRC Ø10 mm		
Electrolyte	A2	
Voltage	46 V	
Temperature recomm.	+20°C (+19.8 °C)	
Polishing time	3 m 0 s	
Light stop value	Ignore	
Graphic time scale	Auto	
Flow mode	Single flow	
Pump flow rate	20	

0.9 Titanium Ø10 mm		
Electrolyte	A3	
Voltage	35 V	
Temperature recomm.	+5°C (+19.8 °C)	
Polishing time	3 m 0 s	
Light stop value	Ignore	
Graphic time scale	Auto	
Flow mode	Single flow	
Pump flow rate	30	

0.11 Copper Ø10 mm		
Electrolyte	D2	
Voltage	10.5 V	
Temperature recomm.	+17°C (+19.8 °C)	
Polishing time	3 m 0 s	
Light stop value	Ignore	
Graphic time scale	Auto	
Flow mode	Single flow	
Pump flow rate	35	

0.13 Brass Ø10 mm		
Electrolyte	D2	
Voltage	13 V	

0.13 Brass Ø10 mm		
Temperature recomm.	+5°C (+19.8 °C)	
Polishing time	3 m 0 s	
Light stop value	Ignore	
Graphic time scale	Auto	
Flow mode	Single flow	
Pump flow rate	25	

0.15 Bronze Ø10 mm		
Electrolyte	D2	
Voltage	17 V	
Temperature recomm.	+5°C (+19.8 °C)	
Polishing time	3 m 0 s	
Light stop value	Ignore	
Graphic time scale	Auto	
Flow mode	Single flow	
Pump flow rate	30	

0.17 Aluminum Ø10 mm		
Electrolyte	A2	
Voltage	40 V	
Temperature recomm.	+5°C (+19.8 °C)	
Polishing time	3 m 0 s	
Light stop value	Ignore	
Graphic time scale	Auto	
Flow mode	Single flow	
Pump flow rate	19	

Final thinning

There are 10 preset methods for final thinning. They are shown with a 3 mm diameter and a small light source symbol next to the electrolyte name.

Select the method you wish to use.

Methods

0.2 Stainless steel Ø3 mm		*
Electrolyte	A8	
Voltage	50 V	
Temperature recomm.	+15°C (+19.8 °C)	
Polishing time	No limit	
Light stop value	Auto	
Graphic time scale	Auto	
Flow mode	Single flow	
Pump flow rate	12	

0.4 Low C steel Ø3 mm		*
Electrolyte	A2	
Voltage	43 V	
Temperature recomm.	+5°C (+19.8 °C)	
Polishing time	No limit	
Light stop value	Auto	
Graphic time scale	Auto	
Flow mode	Single flow	
Pump flow rate	20	

0.5 Low C steel Ø3 mm		*
Electrolyte	A8	
Voltage	50 V	
Temperature recomm.	+15°C (+19.8 °C)	
Polishing time	No limit	
Light stop value	Auto	
Graphic time scale	Auto	
Flow mode	Single flow	
Pump flow rate	16	

0.7 Impax 45HRC Ø3 mm		*
Electrolyte	A2	
Voltage	30 V	

0.7 Impax 45HRC Ø3 mm		*
Temperature recomm.	+20°C (+19.8 °C)	
Polishing time	No limit	
Light stop value	Auto	
Graphic time scale	Auto	
Flow mode	Single flow	
Pump flow rate	12	

0.8 Impax 45HRC Ø3 mm		*
Electrolyte	A8	
Voltage	60 V	
Temperature recomm.	+15 °C (+19.8 °C)	
Polishing time	No limit	
Light stop value	Auto	
Graphic time scale	Auto	
Flow mode	Single flow	
Pump flow rate	16	

0.10 Titanium Ø3 mm		*
Electrolyte	A3	
Voltage	35 V	
Temperature recomm.	+5°C (+19.8 °C)	
Polishing time	No limit	
Light stop value	Auto	
Graphic time scale	Auto	
Flow mode	Single flow	
Pump flow rate	10	

0.12 Copper Ø3 mm		*
Electrolyte	D2	
Voltage	5 V	
Temperature recomm.	+5°C (+19.8 °C)	
Polishing time	No limit	
Light stop value	Auto	

0.12 Copper Ø3 mm		*
Graphic time scale	Auto	
Flow mode	Single flow	
Pump flow rate	10	

0.14 Brass Ø3 mm		*
Electrolyte	D2	
Voltage	6 V	
Temperature recomm.	+5°C (+19.8 °C)	
Polishing time	No limit	
Light stop value	Auto	
Graphic time scale	Auto	
Flow mode	Single flow	
Pump flow rate	10	

0.16 Bronze Ø3 mm		*
Electrolyte	D2	
Voltage	7.4 V	
Temperature recomm.	+5°C (+19.8 °C)	
Polishing time	No limit	
Light stop value	Auto	
Graphic time scale	Auto	
Flow mode	Single flow	
Pump flow rate	10	

0.18 Aluminum Ø3 mm		*
Electrolyte	A2	
Voltage	40 V	
Temperature recomm.	+5°C (+19.8 °C)	
Polishing time	No limit	
Light stop value	Auto	
Graphic time scale	Auto	
Flow mode	Single flow	
Pump flow rate	13	

6.2.2 Selecting a method

1. From the **Main menu** screen, select the **Struers Methods** screen.

Two different types of methods are shown for each material. The methods contain all the settings needed for the process.

- Pre-thinning and blanking

There are 8 preset methods for pre-thinning and blanking. They are shown with a 10 mm diameter and a small clock symbol next to the electrolyte name.

- Final thinning

There are 10 preset methods for final thinning. They are shown with a 3 mm diameter and a small light source symbol next to the electrolyte name.

2. Select the method you wish to use.



6.2.3 Creating a method

To create a method:

- Copy a Struers method from the **Struers Methods** folder, and save it in the **User Methods** folder.

or

- Select an empty method or copy an existing method in the **User Methods** folder.
- Rename the method. See [Renaming a method ▶ 43](#).
- Edit the method and save the changes. See [Change the settings ▶ 44](#).

Copying a method

1. From the **Main menu** screen, select one of the following screens:

- **Struers Methods**

or

- **User Methods**



2. Select the method you wish to use.
3. Copy the method: Press **F1 - Copy**.



4. Press **Enter** to confirm your selection.



5. If you are copying a method from the **Struers Methods** screen:

- Press Back to return to the **Main menu** screen.
 - Select the **User Methods** screen.
6. In the **User Methods** screen, select the field where you want to insert the new method.
 7. Insert the method. Press **F2 - Insert**.
 8. If you are using an empty method, the name automatically changes from **Empty method** to **Unnamed method**.
 9. Press **Enter** to confirm your selection.



6.2.4 Creating a method not based on Struers methods

If you are working with materials which are not covered by the methods in the **Struers Methods** database, you can create a new method. To do so, you must perform a scan.

Procedure

1. From the **Main menu** screen, select the **User Methods** screen.
2. Select a method you wish to use for the new material, for instance an empty method or copy a method from the Struers screen.
3. Press **Enter** to view the settings in the selected method.
4. If needed, change the **Electrolyte** setting to the correct electrolyte for your new material.
5. Press **F1** to select the **Scan** function.
6. Select the **Set max. volt.** setting, and set maximum voltage that will be applied during the scan:
 - 10 - 100 V
7. Select and set the **Set flow rate** setting.
8. Start the scan: Press Start.



The scanning result

1. When the scan is completed, view the current density curve: Press **Enter**.



Example - the scanning result

In this example the graph shows the current density curve. You can use this result to define an approximate value for the polishing voltage. The tangent, **T** cuts the curve in the middle. You can use this value to optimise the polishing voltage setting.

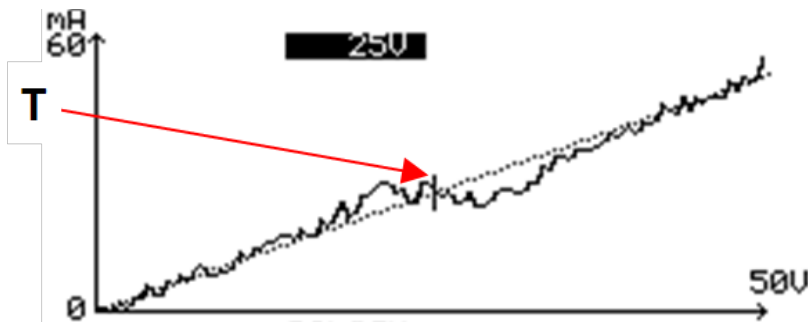

Filtering the scan

If there is a lot of "noise" on the scanning curve, it can be difficult to define the correct polishing voltage.

1. Press **F3 Filter scan** to clean the scanning curve.



Example - filtered scanning curve

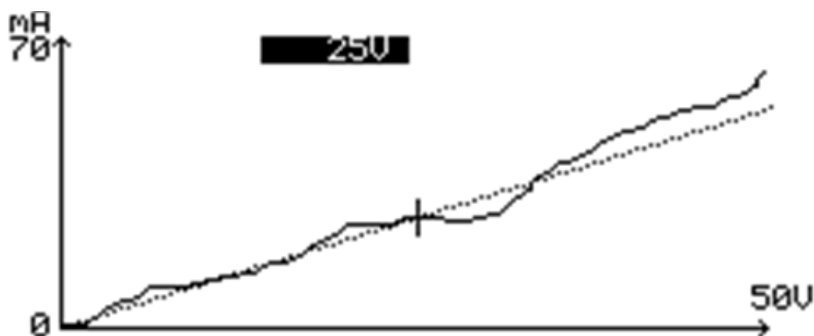

Enhancing the scan

You can optimize the scanning curve even further, if it still is difficult to determine the correct polishing voltage.

1. Press **F4 Enhance scan** to amplify the scanning curve.



Example - enhanced scanning curve

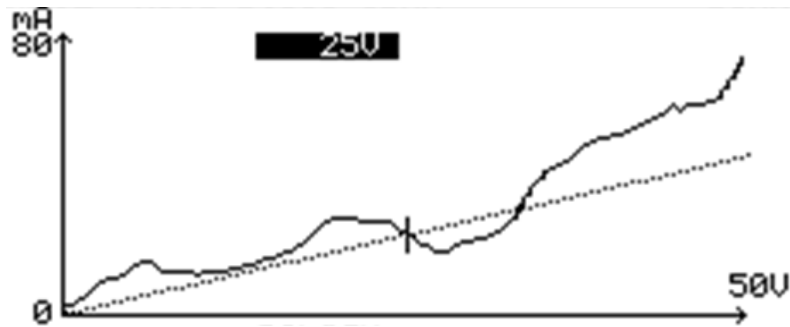

Example - the ideal current density curve

In this example the different areas for polishing and etching are shown.

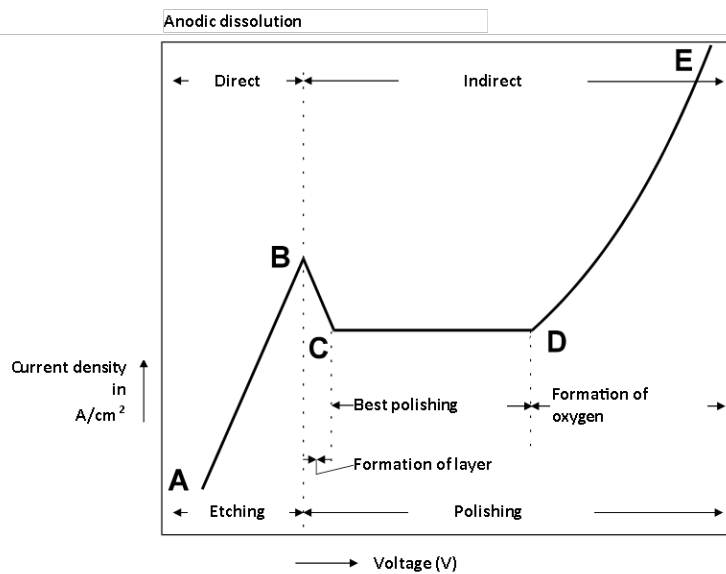

Defining the polishing voltage

The formation of a viscous layer is necessary to achieve the best electrolytic polishing results.

- The formation starts in the area **B – C**.
- The area **C – D** is best for polishing.
- The thickest viscous layer is found in the area **C – D** where the highest voltage/current ratio is found.

Struers tests show that the thickest possible viscous layer give the most uniform polishing results.

- In the area **D – E** the formation of oxygen occurs. This will produce pittings and is not suited for polishing or etching.

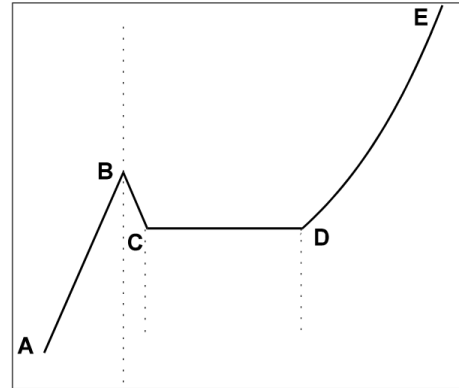

You can use the tangent to define the point with the thickest viscous area.

1. Move the tangent along the current density curve in the area **C – D** until the tangent shows the smallest angle relative to the X-axis (point **T₁**).

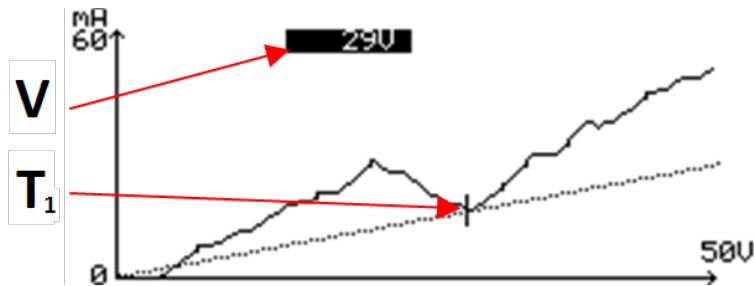

2. Press **F2** to enter the polishing voltage in the method.

The voltage where the tangent is touching the current density curve is shown on the screen, **V**.



3. Press **Back** to return to the method.

The voltage values for polishing has been inserted in the method.



4. Save the new settings for the voltage: Press **F4 - Save**.



Repeating the scan

1. If you wish to repeat the scan, while the screen shows the current density curve press **F1 - Scan**.



Checking the size of the hole

To check the size of the hole made, you can measure the hole again after the thinning process.

1. Press **F3 Hole**. The polishing chamber will be filled with electrolyte and the light value will be measured again.



6.2.5 Renaming a method

You can rename a method to a name of your choice.



Note

You cannot edit or change the names of the methods in the **Struers Methods** database.

1. From the **Main menu** screen, select the **User Methods** screen.
2. Select the method you wish to rename.
3. Press **F4 - Rename**.
4. You will be prompted to accept the text shown or to press Down to select the editing function.



See [Changing text ▶43](#).

6.2.6 Changing text

To change a text value, select the field for entering the text.

1. Place the cursor on the character you wish to change.
 - F1:** Move the cursor to the left.
 - F3:** Move the cursor to the right.
2. Go to the character set.
3. Move the cursor and select the characters you wish to enter.
 - **F1:** Move the cursor to the left.
 - **F2:** Delete one character in the text.
 - **F3:** Move the cursor to the right.
 - **F4:** Insert a space in the text.
4. Place the new character in the text and move the cursor.
5. Repeat the procedure for each character.
6. Save the changes.
7. Exit the text editor.

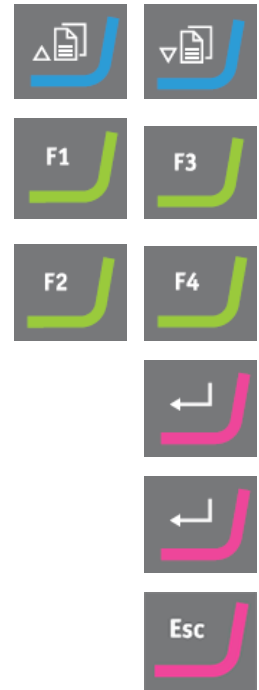

6.2.7 Change the settings



Note
You cannot change the names of the methods in the **Struers Methods** database.

You can change settings in a method to suit your requirements.

- When you change a setting in a method, **F4 Save** is shown on the bottom line of the screen.
- If you are making changes in an existing method, the original method will be overwritten when you save changes.
- If you want to keep both the original method and the new version, make a copy of the method with a new name, and make the changes in the copy.

Procedure

To change a setting, select the field for changing the setting.

1. Select the setting you wish to change.
 - If it is a numeric value, two square brackets [] appear around the value.
 - If it is an alphanumeric value, a pop-up menu appears.
2. Select the desired value.
 - If there are two values, toggle between the values.
3. Save the changes.
4. Confirm your changes.



Settings

Electrolyte			
The standard Struers electrolytes are included. 10 user-defined electrolytes can be added.			
Voltage			
0.1 – 100.0 V in steps of 0.1 V.			
Temperature recomm.			
Recommended temperature: –50°C to +45°C (–58°F to +113°F).			
The actual temperature of the electrolyte is shown in parentheses next to the recommended temperature.			
For instructions on how to set Temp. warning , see Max. Temperature , The configuration screen ▶ 22			
Polishing time			
If the setting Light stop value is set to Auto (automatic mode), where the hole is detected automatically, the setting No Limit must be used.			
Settings for Polishing time			
	1 s steps	5 s steps	10 s steps
No Limit	0-30 s	30-60 s	60 s-30 min

Light stop value						
<ul style="list-style-type: none"> Auto The polishing unit is equipped with an infrared sensor, which constantly measures light emitted from an infrared light source placed on the opposite side of the specimen. When the specimen is thin enough to allow light to pass through, i.e. a hole has been made, the polishing process stops automatically and the reached value is shown on the screen. As the holes sometimes develop very fast a relatively high value can be seen. Time If the polishing process is stopped immediately, the hole may be too small. In this case, you can set the Light stop value setting manually. The value should be higher than the value reached with the Auto setting which is usually is the lowest value that can be achieved with for the processed material. 						
Settings for Light stop value						
	1 s steps	2 s steps	5 s steps	10 s steps	25 s steps	50 s steps
Auto	0-50	50-100	100-500	500-1000	1000-2000	2000-4096

Graphic time scale
10 s to 30 min.
While the process is running the current-time graph is updated continuously. When the Graphic time scale setting is set to Auto , the last three minutes of the process are displayed. If shorter or longer time graphs are shown, you can change the setting.

Flow mode
There are three different flow modes:
<ul style="list-style-type: none"> Single flow The same flow rate is used throughout the polishing process. If the total polishing time is known, use dual flow to reduce the flow towards the end of the process. This can minimize damage to the very thin edges due to too high a flow of electrolyte. There are two options: Dual flow, step mode The flow is reduced from the initial flow to the final flow in one step. Dual flow, ramp mode The flow is reduced gradually from the initial flow to the final flow.

Pump flow rate
0 - 50

6.2.8 Resetting a method

You can reset a method to its default values.

**Note**

You cannot edit or change the names of the methods in the **Struers Methods** database.

1. From the **Main menu** screen, select the **User Methods** screen.
2. Select the method you wish to reset.
3. Reset the method: Press **F3 - Reset**.
4. Press **Enter** to confirm your selection.



6.3 Electrolytic preparation

Specimens for electrolytic thinning should have a diameter of 3 mm and of a thickness of 0.1 - 0.5 mm.

They can be prepared by spark-machining, mechanical turning or cutting. Alternatively, use TenuPol-5 to pre-thin the specimens to produce discs of the required size.

Thinning options

You can use TenuPol-5 to carry out three different types of electrolytic thinning:

- Pre-thinning. See [Pre-thinning the specimen ▶ 48](#).
- Blanking. See [Blanking/Punching ▶ 48](#).
- Final thinning. See [Final thinning ▶ 50](#).

Oxidation

**Note**

It is important to prevent oxidation of the specimens as this will interfere with the electrolytic polishing process.

Specimens which have been punched out of a foil must be fine-ground on both sides to remove any oxidation before preparation.

6.3.1 Preparing a specimen for pre-thinning

1. Cut a specimen with a diameter of max. 21 mm on a precision cut-off machine (e.g. Accutom).
2. Use double-adhesive tape to mount the disc on a plane block of metal.
3. Use a grinding/polishing machine (e.g. Tegramin) with SiC Paper to grind the disc.
4. Grind the disc on the opposite side until the specimen has reached a thickness of max. 1 mm.
5. If needed, use AccuStop for plane-parallel grinding of specimens.

6. Finish the preparation with # 1000 SiC Paper.

6.3.2 Pre-thinning the specimen



WARNING

Do not touch, move or tamper with the unit during use.



CAUTION

Always use goggles or a protective shield, and chemical-resistant gloves.



Hint

Both the specimen holder and jets are available as accessories.

Specimens to be pre-thinned must be max. 1 mm thick with a max. diameter of 21 mm.

The specimens are thinned to a thickness of max. 0.1 - 0.5 mm.

Polishing time will vary depending on the original thickness of the specimen and must be determined for the particular material.

Use the 10 mm specimen holder and the 2.5 mm jets (option).

Procedure

1. Place the specimen in a 100 mm specimen holder. See [Placing a specimen in the specimen holder ▶ 49](#)
2. Use the 2.5 mm jets for a preset time to polish the specimen.
3. The polishing time must be determined for the selected material and varies depending on the original thickness of the specimen.

After pre-thinning, the thickness should be 0.1 - 0.5 mm.

6.3.3 Blanking/Punching

You can electrolytically extract specimens of 3 mm (or 2.3 mm) using the 10 mm specimen holder and 2.5 mm jets (option).

Areas of the specimen are blanked by using acid -resistant tape (option).

1. Prepare a small bath of e.g. ethanol or distilled water and place it close to the polishing unit.
2. Degrease the specimen with alcohol.
3. Cover one side of the specimen with acid-resistant tape (option).
4. On the other side of the specimen, place 1 - 4 discs of acid -resistant tape with a diameter of 3 mm or 2.3 mm within a circle with a diameter of 10 mm.
5. Press the tape firmly against the metal.
6. Place the specimen in the 10 mm specimen holder.
7. Place the specimen holder in the polishing cell.

- Disconnect the cathode on the side where the specimen is completely covered by pulling out the mini-jack plug.

**WARNING**

Do not touch, move or tamper with the unit during use.

- Polish the specimen until the exposed area has disappeared leaving specimens of 3 mm or 2.3 mm under the acid-resistant tape discs.
The polishing time must be determined for the selected material and varies depending on the original thickness of the specimen.
- Stop the process.
- Take the specimen holder out of the polishing cell and open it in the bath of e.g. ethanol or distilled water to stop chemical etching.
- Use a pair of tweezers to move the specimen to a bath of ethanol.
- Place the specimen on a piece of filter paper and leave it to dry for a moment.
- The specimen is ready for final thinning or storage.

6.3.4 Placing a specimen in the specimen holder

The specimen to be placed in the specimen holder must be 3 mm in diameter with a thickness of 0.1 - 0.5 mm. See [Preparing a specimen for pre-thinning ▶ 47](#).

- Take the two parts of the specimen holder apart by turning them in opposite directions.
A
- Remove the diaphragm. **B**
- Join the two parts of the specimen holder (you can hear a click). Do not insert the diaphragm.
- Place the specimen holder with the cut-out part facing upwards.
- Place the specimen holder over the hole of the platinum strip.
- Carefully press the diaphragm down into the cut-out until it fits tightly against the specimen.

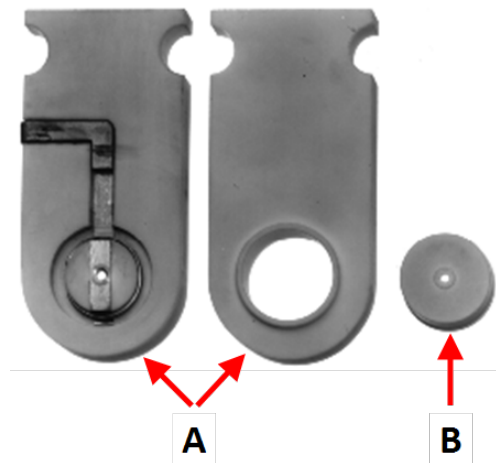

A Specimen holder

B Diaphragm

6.3.5 Starting the thinning process

**CAUTION**

Always use goggles or a protective shield, and chemical-resistant gloves.

**WARNING**

Do not touch, move or tamper with the unit during use.

1. Prepare a small bath of e.g. ethanol or distilled water and place it close to the polishing unit.
2. Make sure that you have filled the electrolyte container with the correct type and amount of electrolyte.
3. Place the specimen holder in the polishing cell so that the contact piece of the specimen holder faces towards the contact piece of the polishing cell.
4. Select the correct method. See [Selecting a method ▶ 38](#).
5. Make sure that the temperature of the electrolyte is set correctly.
6. Press Start on the control panel of the control unit.

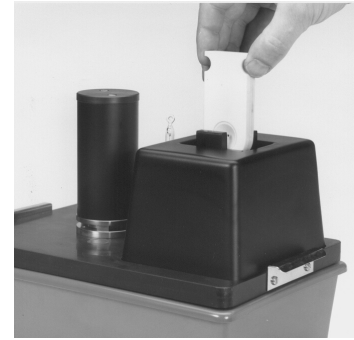

6.3.6 Post-treatment of the specimen



CAUTION

Always use goggles or a protective shield, and chemical-resistant gloves.



WARNING

Do not touch, move or tamper with the unit during use.



Note

Prepare a small bath of e.g. ethanol or distilled water and place it close to the polishing unit.

When the thinning process is finished, the current is interrupted and you will hear the sound of a beep.

1. Take the specimen holder out of the polishing cell and open it in the bath of e.g. ethanol or distilled water to stop chemical etching.
2. Use a pair of tweezers to move the specimen to a bath of ethanol.
3. Place the specimen on a piece of filter paper and leave it to dry for a moment.

Protecting specimens from oxidation

- Store thinned specimens under vacuum in a desiccator with silica gel.
- Usually, you can store specimens in glycerol.

6.3.7 Final thinning

- To polish specimens with a diameter of 3 mm (or 2.3 mm), use the 1 mm jets.

Polishing is carried out until a small hole appears. The process is usually stopped by using the setting for **Light stop value** (light passing through the specimen detects when a hole is formed).

- To change the size of the hole, change the setting of **Light stop value**.

**Hint**

Thinned specimens can be kept under vacuum in a desiccator with silica gel. In most cases, you can also keep thinned specimens in glycerol to protect them from oxidation.

6.3.8 Stopping the thinning process

**CAUTION**

Always use goggles or a protective shield, and chemical-resistant gloves.

**WARNING**

Do not touch, move or tamper with the unit during use.

- If you have set the **Light stop value** setting, the process will stop automatically when a hole is made in the specimen. This is normally used for the final thinning.
- If you have set the **Polishing time** setting, the process will stop automatically when the pre-set time has run out, whether a hole has been made or not. The timer is normally used for pre-thinning and blanking.

- You can stop the process at any time by pressing Stop.



See [Post-treatment of the specimen](#) ► 50.

6.3.9 Emptying the electrolyte container

**CAUTION**

Always use safety gloves, goggles and a funnel when you handle electrolytes.

- Remove the base plate with the pump and cooling coil from the insulated electrolyte container.
- If you are going to reuse the electrolyte, use the funnel to pour it carefully back into the electrolyte container.
- If you are disposing of the electrolyte, fill it into a container suitable for disposal.

**Note**

Always observe the current safety regulations regarding handling and disposal of electrolytes.

6.3.10 Cleaning the polishing cell



CAUTION

Always use goggles or a protective shield, and chemical-resistant gloves.

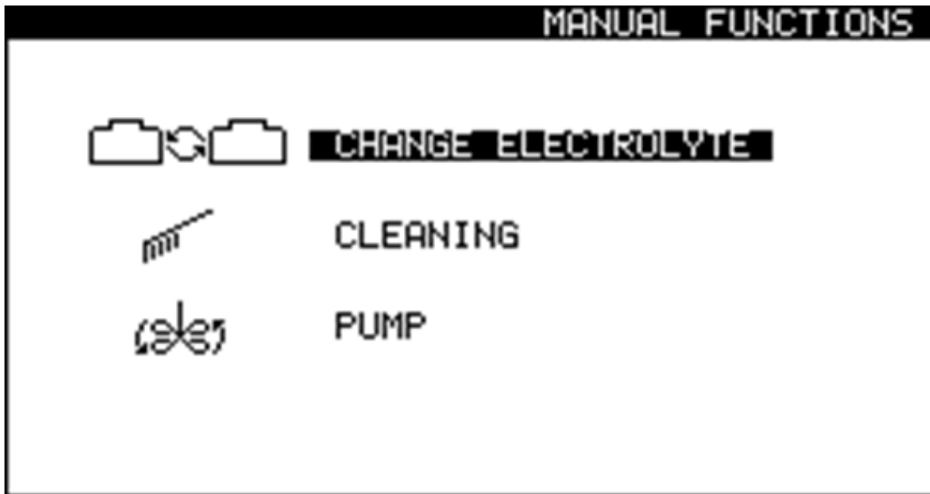

When you have emptied the reservoir of electrolyte, you must clean the polishing unit with water by pumping water through the polishing cell.

1. Fill the reservoir with water.
2. From the **Main menu** screen, select **Manual funct. > Cleaning**.
3. See [Cleaning ▶ 57](#).

6.4 Optimizing the results

If the quality of the electrolytic polishing is not satisfactory, you can change the polishing conditions.

These aspects can influence on the quality:

- The type of electrolyte
- The flow rate of the electrolyte
- The temperature
- The electrical conditions

If the results do not improve, the electrolyte probably is not suitable for thinning the material being processed, even though it will electropolish the material. Try another type of electrolyte.

6.4.1 Electrolytes

The chemical composition of the electrolyte is very important for the polishing quality.

An unsuitable electrolyte will result in lower quality polishing, oxidized or etched surface, pittings, or one-sided polishing where only one side of the specimen is polished and the other is black and oxidized.

An electrolyte that results in good polishing of a specific material when other equipment is used may not show as good results with this machine.

Electrolytes

- Check the age of the mixed electrolyte. The mixture should not be more than 3 months old.
- Check the number of polishings made with the electrolyte. The electrolyte can be worn out by too many polishings.
- Make sure that the correct combination of material and electrolyte is used.
- Make sure that the electrolyte is cooled sufficiently during operation.

6.4.2 Flow rate

The flow rate determines whether a viscous, anodic layer can be maintained during polishing.

A correct flow rate must be based on the material to be polished and by the electrolyte.

The best flow rate varies from case to case, and must be determined on an individual basis.

Jet polishing tends to remove the layer.

6.4.3 Temperature

In some cases a lower temperature setting gives better results. A lower temperature setting slows down the polishing process and results in less etching and oxidation.

6.4.4 Electrical conditions

The electrical conditions determine whether polishing is obtained at all. The right conditions will only be present within a certain range of current densities.

6.4.5 Polishing defects

The polishing defects are divided into the following classes for this machine:

- Defective polishing, where the polishing conditions prevent the result from being mirror-like on one or both sides of the specimen. Pitting can occur.
- Polishing is performed, but there is no thin area at the edge of the hole.

Defective polishing

Changing the electrical conditions can improve the process.

- The voltage may have been too low to reach the polishing range.
- Pittings can occur if the current is too high.
- Lowering the temperature can make the polishing process less sensitive to voltage changes.
- The flow rate can be changed. A too high flow rate can break up the polishing layer, which may prevent one side of the specimen from being polished. A slower flow rate can cause a polishing layer to build up.

If the results do not improve, the material being processed probably cannot be polished by the electrolyte. Try another type of electrolyte.

The polishing circuit**CAUTION**

Always use goggles or a protective shield, and chemical-resistant gloves.

**WARNING**

Do not touch, move or tamper with the unit during use.

- Make sure that all plugs are properly connected.
- Make sure that the stainless specimen holder contact part is intact and connected to the platinum strip.
- Make sure that the specimen holder is connected to the polishing chamber spring contact it is when mounted in the chamber.
- Check the voltage over the spring contact.
- Check the jet holder mini-jack plugs.
- Check the platinum wire in the jets.

6.4.6 The hole is too big

The hole may have grown too big, so that the thin foil that was formed first has disappeared. Electrolytic polishing attacks the tops of the asperities of the surface, and also attacks the edge of the hole as if it is an asperity. When the jet effect is strong it is very important to stop the process while the hole is small.

- If needed, adjust the flow rate. A strong jet can attack an area that is too small.
- If needed, change the density of the electrical current.
- Set the **Light stop value** setting to **Auto**.
- A lower temperature setting will give a better profile around the hole because of a change in the viscosity.

7 Maintenance and service

Proper maintenance is required to achieve the maximum up-time and operating lifetime of the machine. Maintenance is important in ensuring continued safe operation of your machine.

The maintenance procedures described in this section must be carried out by skilled or trained personnel.

Safety Related Parts of the Control System (SRP/CS)

For specific safety related parts, see the section "Safety Related Parts of the Control System (SRP/CS)" in the section "Technical data" in this manual.

Technical questions and spare parts

If you have technical questions or when you order spare parts, state serial number and voltage/frequency. The serial number and the voltage are stated on the type plate of the machine.

7.1 Manual functions

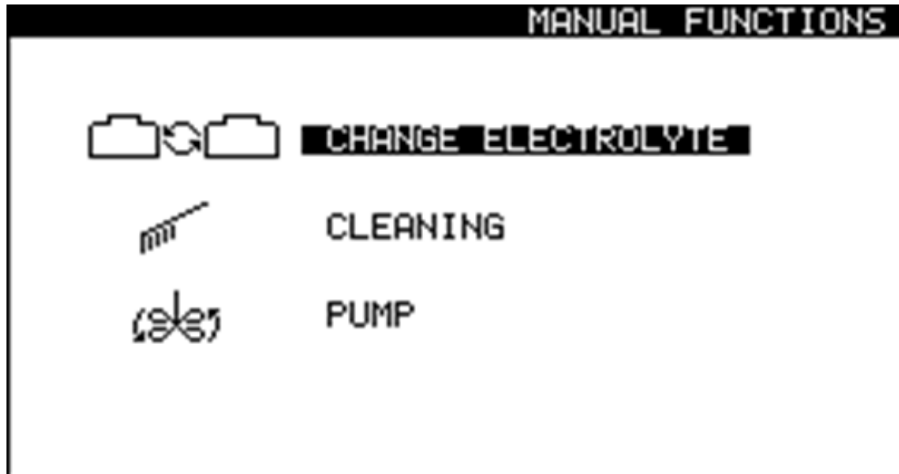

A number of manual functions are available in the software.



1. From the **Main menu** screen, select the **Manual funct.** screen.



From the **Manual Functions** screen you can choose between the following options:

-  • **Change electrolyte.** See [Changing electrolyte](#) ► 55.
-  • **Cleaning.** See [Cleaning](#) ► 57.
-  • **Pump.** See [Operating the pump manually](#) ► 58.

7.1.1 Changing electrolyte

When you change from a method that uses one type of electrolyte to a method that uses a different type of electrolyte, you must change the electrolyte. You will be prompted to change the electrolyte and clean the system. If needed, you can start this function manually.



CAUTION

Always use goggles or a protective shield, and chemical-resistant gloves.



WARNING

Do not touch, move or tamper with the unit during use.

1. From the **Main menu** screen, select the **Manual funct.** screen.



2. From the **Manual Functions** screen, select the **Change electrolyte** screen.



3. Press **Enter** to continue.



4. Follow the on-screen instructions. The on-screen instructions are listed below.



5. Press **Enter** to continue through the sequence of steps.

You can cancel the process at any time. To do so, press **Escape**.



6. The following messages appear.

[Remove Electrolyte:]

1. **Lift the polishing unit.**
2. **Place it in the container with water**
3. **Remove the present elec.**

[Cleaning...]

**The system is being cleaned now.
Please wait 54s**

[Cleaning done]

1. **Lift the polishing table.**
2. **Use alcohol to remove water.**
3. **Clean off the remaining alcohol.**

[Remove water]

Remove the water.

[Select new Electrolyte]

A2

A3

A8

...

10% oxalic

USER 1

7.1.2 Cleaning

When you have finished using the machine, you must clean the system.



CAUTION

Always use goggles or a protective shield, and chemical-resistant gloves.



WARNING

Do not touch, move or tamper with the unit during use.

1. From the **Main menu** screen, select the **Manual funct.** screen.
2. From the **Manual Functions** screen, select the **Cleaning** screen.
3. Press **Enter** to continue.
4. Follow the on-screen instructions. The on-screen instructions are listed below.
5. Press **Enter** to continue through the sequence of steps.



You can cancel the process at any time. To do so, press **Escape**.



6. The following messages appear.
 - [**Remove Electrolyte:**]
 - 1. **Lift the polishing unit.**
 - 2. **Place it in the container with water**
 - 3. **Remove the present elec.**

[**Cleaning...**]

The system is being cleaned now.

Please wait 54s

[Cleaning done]

1. Lift the polishing table.
2. Use alcohol to remove water.
3. Clean off the remaining alcohol.

[Remove water]

Remove the water.

7.1.3 Operating the pump manually

You can activate the pump and adjust the flow rate manually.

1. From the **Main menu** screen, select the **Manual funct.** screen.
2. From the **Manual Functions** screen, select the **Pump** screen.
3. Press **Enter**.
4. Adjust the flow rate.
5. Press **Enter** or **Escape** to stop the pump.



7.2 Daily

Clean the machine every day after you finish working, as any electrolyte residue in the polishing cell can affect subsequent preparations.

Polishing unit

Rinse the polishing cell and pump thoroughly with water before you fill any new electrolyte and at the end of each working day.



WARNING

Never use acetone or similar solvents.

**CAUTION**

Never turn the polishing unit upside down, particularly if there is electrolyte in the pump.

**Note**



Never leave the machine filled with electrolyte for longer periods of time, as this can cause the submerged parts to corrode.

**Note**

Make sure that the motor housing never comes in contact with the electrolyte.

**Note**

If you have been working with copper or copper alloys, some copper can have deposited on the cathodes. Remove it using a few drops of nitric acid before rinsing.

1. From the **Main menu** screen, select the **Manual funct.** screen. 
2. From the **Manual funct.** screen, select the **Pump** screen. See [Operating the pump manually ▶58](#). 
3. Start the pump and set the flow rate to 50.
 - Make sure that the flow from the jets is equal and that there are no blockages.
 - If you detect any blockage or leak, stop the pump and clean the jets thoroughly before restarting the pump.
 - Repeat until the flow from the jets is satisfactory.
 - Stop the pump.
4. Place a specimen holder in the polishing chamber.
5. Follow the instructions for cleaning: See [Cleaning ▶57](#).
6. When the cleaning program is finished, clean all accessible surfaces with a damp cloth, including the inside of the electrolyte container.
7. Wash all the used specimen holders thoroughly.

7.2.1 Control unit

- Avoid spilling electrolyte on the cabinet or on the front plate of the control unit.
- Clean the front plate with a damp cloth after use.

7.3 Weekly

Clean the control unit with a damp cloth.

7.4 Monthly

Recirculation unit

See the Instruction Manual for this unit.

**Note**

Replace the cooling fluid immediately if you notice that it is infected by algae or bacteria.

7.4.1 Calibrating the pump

The first time the machine is switched on

The pump must be adjusted before it is used for the first time.

To start the pump adjustment procedure, carry out the following:

1. The first time you switch on the machine, the following message is shown:

The pump must be adjusted.

1. Insert the calibration holder in the polishing cell.
2. Place the black tube in the thermo sensor hole.
3. Connect the calibration holder.
4. Select **Adjust with tube**.
5. To continue with the pump adjustment procedure, see [Carrying out the adjustment ▶ 61](#) in this section.

Subsequent use

If the results are not correct, or if you cannot reproduce the results, adjust the pump.

This function calibrates the pump of the polishing unit and ensures that the flow rate settings in the Struers methods are correct.

1. Insert the calibration holder in the polishing cell.
2. Place the black tube in the thermo sensor hole.
3. Connect the calibration holder.
4. From the **Main menu** screen, select the **Configuration** screen.
5. Press **F4 - Adj. Pump**.
6. To continue with the pump adjustment procedure, see [Carrying out the adjustment ▶ 61](#) in this section.

Carrying out the adjustment

The following message is shown:

Insert container

Please insert a container filled with 1.5 litre water.

Add a drop of detergent.

7. Fill the container with 1.5 liters of water.
8. Add one drop of detergent to release the surface tension of the water.
9. Press **Enter** to continue.

The following message is shown:

Insert tubes

Insert jet holder with ascending tube, return tube and specimen holder with specimen.

10. Do as instructed.
11. Press **Enter** to continue.
12. Select **Maximum pump flow**.
13. Press **Enter** to start the pump.
14. Adjust the water level to the upper mark. The maximum setting should be approx. 120.
15. Press **Enter** to save the value.
16. Select **Minimum pump flow**.
17. Adjust the water level to the lower mark. The minimum setting should be approx. 75.
18. Press **Enter** to save the value.
19. When you have completed the adjustment, press **Escape**.



7.5 Annually

The safety devices must be tested at least once a year.

7.5.1 Test the safety devices



WARNING

Do not use the machine with defective safety devices. Contact Struers Service.

Protective cover

The safety devices must be tested at least once a year.



WARNING

Do not use the machine with defective safety devices.
Contact Struers Service.

Procedure

1. To inspect the protective cover and the work zone interlock, remove the protective cover including the work zone interlock.
2. Press Start.
3. Make sure that polishing does not start.



7.6 Spare parts

Technical questions and spare parts

If you have technical questions or when you order spare parts, state the year of production. The year of production is engraved on the cylinder frame.

For further information, or to check the availability of spare parts, contact Struers Service. Contact information is available on Struers.com.

7.7 Service and repair

We recommend that a regular service check be carried out yearly or after every 1500 hours of use.

When the machine is started up, the display shows information about total operation time and the machines service information.

After 1500 hours of operation time, the display will show a message reminding the user that a service check should be scheduled.



Note

Service must only be performed by a qualified technician (electromechanical, electronic, mechanical, pneumatic, etc.).
Contact Struers Service.

7.8 Disposal



Equipment marked with a WEEE symbol contains electrical and electronic components and must not be disposed of as general waste.

Contact your local authorities for information on the correct method of disposal in accordance with national legislation.

For disposal of consumables and recirculation fluid, follow local regulations.

Electrolytes

Contact your local authorities for information on the correct method of disposal in accordance with national legislation.

8 Troubleshooting

Control unit

Error	Cause	Action
The supply voltage is too low.	The power supply voltage is too low compared to the voltage stated on the back of the control unit.	If needed, change the voltage setting. See Voltage ▶ 27 .
No electrical connection.	There is no connection to the polishing unit.	Make sure that the polishing unit is connected to the back of the control unit.
	Too little electrolyte in the electrolyte container.	Increase the amount of electrolyte in the container up to a maximum of 1.5 l.
	The protective cover switch is not activated.	Ensure the protective cover is placed correctly in the groove, and you can hear a relay click in the control unit.
Temperature is above max. limit.	The electrolyte temperature is above the preset limit.	Connect the device to tap water or an external cooling unit and wait until the temperature is below the specified limit.
The device is switched on but the display is blank.	The backlight of the display has been turned off.	Press any button to reactivate the backlight.

See also [Optimizing the results ▶ 52](#).

9 Technical data

9.1 Technical data - TenuPol-5

Subject	Specifications	
Software and electronics	Display	128 x 240 dots (16 x 40 characters)
	Controls	Touch pad
	Database	18 Struers methods + 200 user definable methods (non-volatile)
Power supply	50/60 Hz - Max. load: 4 A	1 x 100-120 V
	50/60 Hz - Max. load: 2 A	1 x 220-240 V
Output: Voltage/Current	Polishing	0-100 V (0.1 V steps)/2.5 A
Safety standards	See the Declaration of Conformity	
Dimensions and weight	Width	385 mm (15.2")
	Depth	350 mm (13.8")
	Height	160 mm (6.3")
	Weight	14.7 kg (32.4 lbs)
Operating environment	Surrounding temperature	5-40°C (41-104°F)
	Humidity	0-95 % RH non-condensing
Storage and transport conditions	Surrounding temperature	-25-55°C (13-113°F)
	Humidity	0-95 % RH non-condensing

9.2 Noise and vibration levels

Noise level	A-weighted sound emission pressure level at workstations	$L_{pA} = 55.4 \text{ dB(A)}$ (measured value) Uncertainty $K = 4 \text{ dB}$ Measurements made in accordance with EN ISO 11202
--------------------	--	---

Vibration level	N/A
------------------------	-----

9.3 Safety Circuit Categories/Performance Level

See the instruction manual for TenuPol-5Polishing unit

9.4 Safety Related Parts of the Control System (SRP/CS)



WARNING

Safety critical components must be replaced after a maximum lifetime of 20 years. Contact Struers Service.



Note

SRP/CS (safety-related parts of a control system) are parts that have an influence on safe operation of the machine.



Note

Replacement of safety critical components must only be performed by a Struers engineer or a qualified technician (electromechanical, electronic, mechanical, pneumatic, etc.). Safety critical components must only be replaced by components with at least the same safety level. Contact Struers Service.

Safety related part	Manufacturer/Manufacturer description	Manufacturer catalog no.	Electrical ref.	Struers catalog no.
Interlock switch circuit - Polishing unit	Schmersal Coded-magnet sensor	BNS33-11Z-2M	SS1	2SS00140
Interlock switch circuit - Polishing unit	Schmersal Coded-magnet (actuator) for sensor	BPS33	SS1	2SS00141
Interlock switch circuit - Polishing unit	Finder Power relay	62.32.9.024.4800	K1	2KL46680

9.5 Diagrams



Note

If you want to view specific information in detail, see the online version of this manual.

9.5.1 Diagrams - TenuPol-5

Control unit

Title	No.
TenuPol-5, Block diagram	15393051 A
TenuPol-5, Connection adapter	15393508 B

Polishing unit

See the Instruction Manual for this unit.

15393051 A

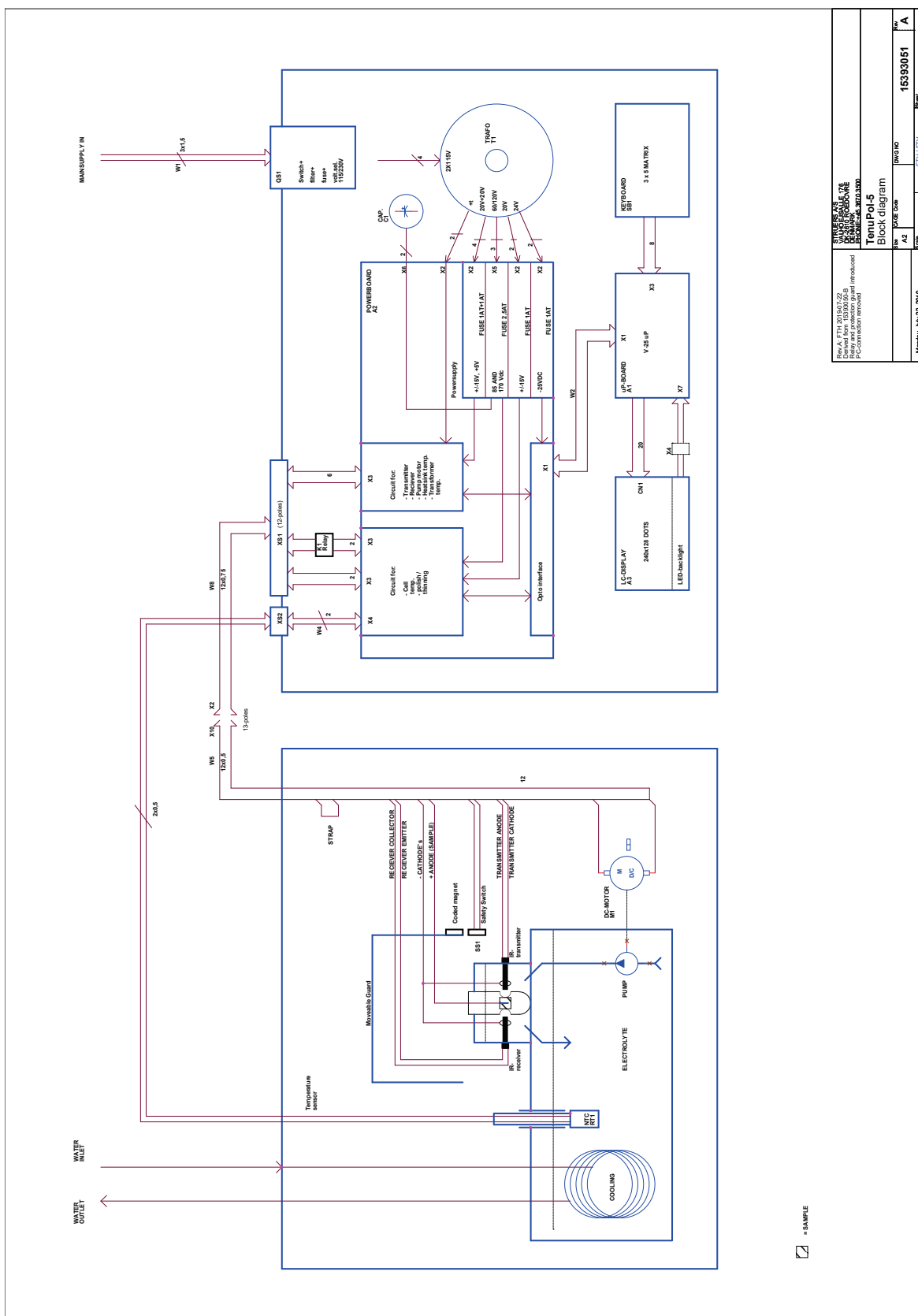

SPPS/STAS WATER POLYMERIZATION LABORATORY Laboratory of Applied Chemistry, University of Groningen, The Netherlands			
Derived from 15393051 B TenuPol-5 (PC-connection removed)			
TenuPol-5 Block diagram			
REV	DATE CHG	DRAWING	PRINT
AZ			
Morey, July 22, 2019			15393051 A
			1 of 1

☑ = SAMPLE

15393508 B

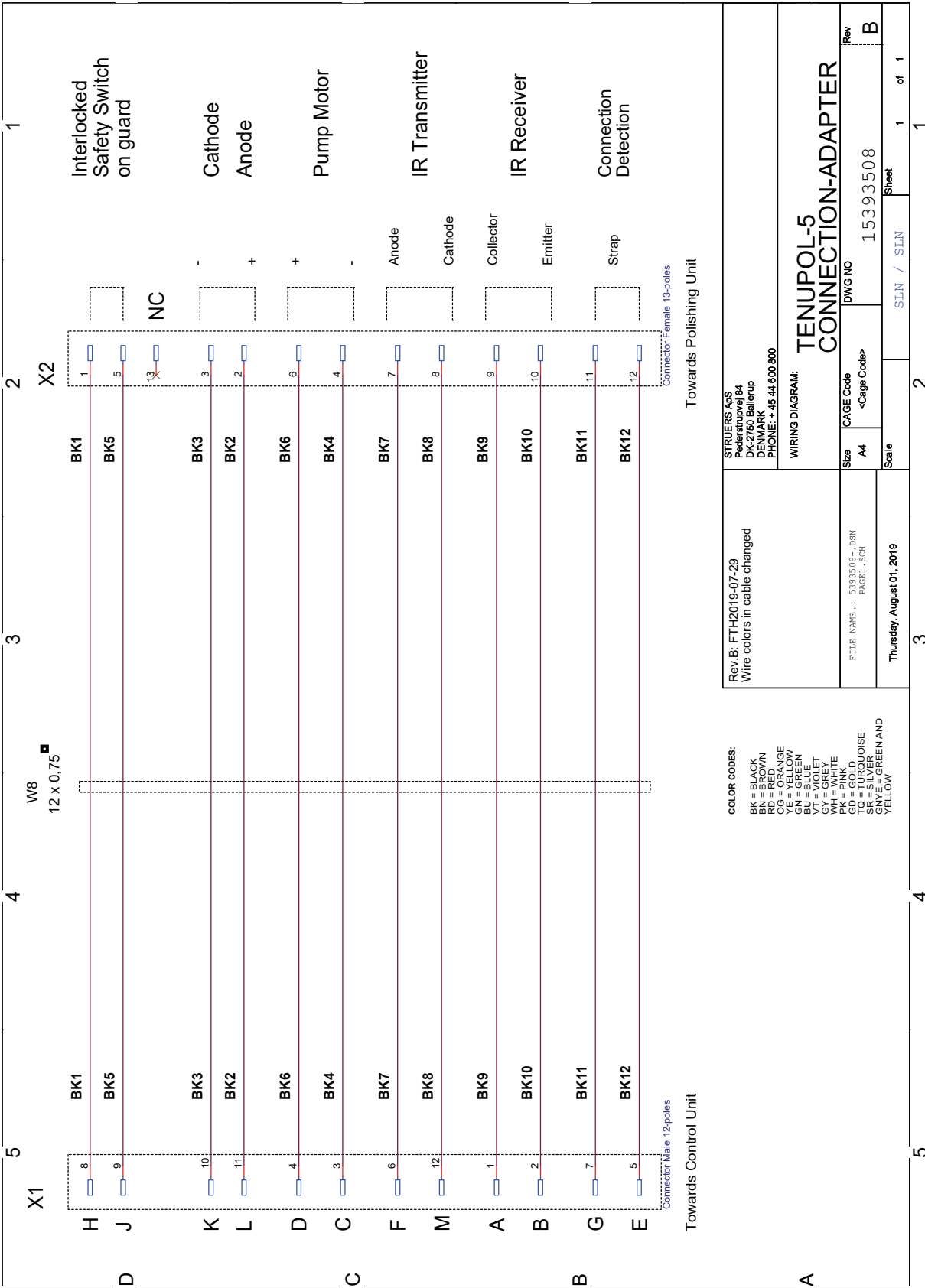

STRUERS Aps Pøstboksvej 64 2600 Ballerup DENMARK PHONE: + 45 44 600 800		Rev.B: FTH2019-07-29 Wire colors in cable changed	
WIRING DIAGRAM: Size: A4 CAGE Code: <Cage Code>		FILE NAME: 5393508-.DSN PAGE1.SCH	
TENUPOL-5 CONNECTION-ADAPTER		Thursday, August 01, 2019	
DWG NO	15393508	Scale	1 of 1
Rev	B	SLN / SLN	1

- COLOR CODES:**
- BK = BLACK
 - RD = RED
 - GR = GREEN
 - OG = ORANGE
 - VE = YELLOW
 - BU = BLUE
 - VT = VIOLET
 - WH = WHITE
 - GRY = GREY
 - PK = PINK
 - GD = GOLD
 - BR = BROWN
 - SR = SILVER
 - GNYE = GREEN AND YELLOW

9.6 Legal and regulatory information

FCC notice

This equipment has been tested and found to comply with the limits for a Class B digital device, pursuant to part 15 of the FCC Rules. These limits are designed to provide reasonable protection against harmful interference in a residential installation. This equipment generates, uses and can radiate radio frequency energy and, if not installed and used in accordance with the instructions, may cause harmful interference to radio communications. However, there is no guarantee that interference will not occur in a particular installation. If this equipment does cause harmful interference to radio or television reception, which can be determined by turning the equipment off and on, the user is encouraged to try to correct the interference by one or more of the following measures:

- Reorient or relocate the receiving antenna.
- Increase the separation between the equipment and receiver.
- Connect the equipment into an outlet on a circuit different from that to which the receiver is connected.

10 Manufacturer

Struers ApS
Pederstrupvej 84
DK-2750 Ballerup, Denmark
Telephone: +45 44 600 800
Fax: +45 44 600 801
www.struers.com

Responsibility of the manufacturer

The following restrictions should be observed, as violation of the restrictions may cause cancellation of Struers legal obligations.

The manufacturer assumes no responsibility for errors in the text and/or illustrations in this manual. The information in this manual is subject to change without notice. The manual may mention accessories or parts not included in the supplied version of the equipment.

The manufacturer is to be considered responsible for effects on safety, reliability, and performance of the equipment only if the equipment is used, serviced, and maintained in accordance with the instructions for use.

Declaration of Conformity

Manufacturer	Struers ApS • Pederstrupvej 84 • DK-2750 Ballerup • Denmark
Name	TenuPol-5 Control unit
Model	N/A
Function	Electrochemical thinning
Type	539
Cat. no.	05396233 Control unit in combination with 04086002 Polishing unit
Serial no.	



Module H, according to global approach



We declare that the product mentioned is in conformity with the following legislation, directives and standards:

2006/42/EC	EN ISO 12100:2010, EN ISO 13849-1:2015, EN ISO 13849-2:2012
2011/65/EU	EN IEC 63000:2018
2014/30/EU	EN 61000-3-2:2014, EN 61000-3-3:2013, EN 61000-6-1:2007, EN 61000-6-3:2007, EN 61000-6-3-A1:2011, EN 61000-6-3-A1-AC:2012
Additional standards	NFPA 70, NFPA 79, FCC 47 CFR Part 15 Subpart B

Authorized to compile technical file/
Authorized signatory

Date: [Release date]

en For translations see
bg За преводи вижте
cs Překlady viz
da Se oversættelser på
de Übersetzungen finden Sie unter
el Για μεταφράσεις, ανατρέξτε στη διεύθυνση
es Para ver las traducciones consulte
et Tõlked leiate aadressilt
fi Katso käännökset osoitteesta
fr Pour les traductions, voir
hr Za prijevode idite na
hu A fordítások itt érhetők el
it Per le traduzioni consultare
ja 翻訳については、
lt Vertimai patalpinti
lv Tulkojumus skatīt
nl Voor vertalingen zie
no For oversettelser se
pl Aby znaleźć tłumaczenia, sprawdź
pt Consulte as traduções disponíveis em
ro Pentru traduceri, consultați
se För översättningar besök
sk Preklady sú dostupné na stránke
sl Za prevode si oglejte
tr Çeviriler için bkz
zh 翻译见

www.struers.com/Library