

# AbraPol-30

## Instruction Manual

**Original Instructions**



CE

Doc. no.: 16307025-01\_A\_en-us  
Date of release: 2023.03.29

---

**Copyright**

The contents of this manual are the property of Struers ApS. Reproduction of any part of this manual without the written permission of Struers ApS is not allowed.

All rights reserved. © Struers ApS 2023.03.29.

---

# Table of Contents

<b>1 About this manual</b> .....	<b>6</b>
1.1 Accessories and consumables .....	6
<b>2 Safety</b> .....	<b>6</b>
2.1 Intended use .....	6
2.2 AbraPol-30 safety precautions .....	7
2.2.1 Read carefully before use .....	7
2.3 Safety messages .....	8
2.4 Safety messages in this manual .....	9
<b>3 Getting started</b> .....	<b>10</b>
3.1 Device description .....	10
3.2 AbraPol-30 - overview .....	11
<b>4 Transport and storage</b> .....	<b>13</b>
4.1 Storage .....	13
<b>5 Installation</b> .....	<b>13</b>
5.1 Unpack the machine .....	13
5.2 Check the packing list .....	14
5.3 Power supply .....	14
5.4 Noise .....	15
5.5 Vibration .....	15
5.6 Compressed air supply .....	16
5.7 Connect to an exhaust system .....	16
5.8 Connecting to the water supply .....	16
5.9 Connecting to the waste water outlet .....	17
5.10 Connect the recirculation unit (option) .....	17
5.11 Connecting an external recirculation unit (option) .....	19
5.12 Adjusting disc cooling and OP-flushing .....	20
5.13 The dosing pump units .....	20
5.13.1 Placing bottles in the dosing unit .....	21
<b>6 Operate the device</b> .....	<b>21</b>
6.1 Control panel functions .....	22
6.2 The display .....	23
6.2.1 Navigating in the display .....	24
6.2.2 Main menu .....	25
6.2.3 Changing settings and text .....	25

---

6.2.4 Software settings .....	26
6.3 Configuration .....	26
6.3.1 Operation mode .....	27
6.3.2 New pass code .....	28
6.3.3 Bottle configuration .....	28
6.3.4 User defined consumables .....	29
6.3.5 Options .....	31
6.4 Preparation methods .....	33
6.4.1 Creating a preparation method .....	33
6.4.2 Settings .....	34
6.4.3 Changing a preparation method .....	35
6.4.4 Locking a preparation method .....	36
6.4.5 Copying a preparation step .....	36
6.4.6 Deleting a preparation step .....	36
6.4.7 Setting dosing levels .....	37
6.5 The specimen holder .....	37
6.5.1 Clamp and level the specimens .....	37
6.5.2 Inserting or removing the specimen holder .....	38
6.5.3 Adjusting the specimen holder position .....	38
6.6 The preparation process .....	39
6.6.1 The splash guard .....	39
6.6.2 Start the preparation process .....	40
6.6.3 Stopping the preparation process .....	40
6.6.4 The spin function .....	41
<b>7 Maintenance and service .....</b>	<b>42</b>
7.1 General cleaning .....	42
7.2 Daily .....	42
7.2.1 Checking the recirculation tank .....	42
7.3 Weekly .....	43
7.3.1 Cleaning the bowl .....	43
7.3.2 Cleaning the tubes .....	44
7.4 Monthly .....	44
7.4.1 Cleaning the recirculation unit .....	44
7.4.2 Changing the cooling fluid .....	45
7.5 Annually .....	45
7.5.1 Test the safety devices .....	46
7.5.2 Emergency stop .....	47
7.5.3 Safety cover .....	47
7.6 Change the tubes .....	48

---

7.7	Calibrating the pumps .....	50
7.8	Spare parts .....	50
7.9	Service and repair .....	51
7.10	Disposal .....	51
<b>8</b>	<b>Troubleshooting - AbraPol-30 .....</b>	<b>51</b>
8.1	Messages and errors - AbraPol-30 .....	52
8.1.1	Messages .....	52
8.1.2	Errors .....	52
<b>9</b>	<b>Technical data .....</b>	<b>57</b>
9.1	Technical data .....	57
9.2	Safety Circuit Categories/Performance Level .....	60
9.3	Noise and vibration levels .....	60
9.4	Safety Related Parts of the Control System (SRP/CS) .....	60
9.5	Diagrams .....	61
9.5.1	Diagrams - AbraPol-30 .....	62
9.6	Legal and regulatory information .....	66
<b>10</b>	<b>Manufacturer .....</b>	<b>66</b>
	<b>Declaration of Conformity .....</b>	<b>67</b>

# 1 About this manual

**CAUTION**

Struers equipment must only be used in connection with and as described in the Instruction Manual supplied with the equipment.

**Note**

Read the Instruction Manual carefully before use.

**Note**

If you wish to view specific information in detail, see the online version of this manual.

## 1.1 Accessories and consumables

### Accessories

For information about the available range, see the AbraPol-30 brochure:

- [The Struers Website](http://www.struers.com) (<http://www.struers.com>)

### Consumables

The equipment is designed to be used only with Struers consumables specifically designed for this purpose and this type of machine.

Other products may contain aggressive solvents, which dissolve e.g. rubber seals. The warranty may not cover damaged machine parts (e.g. seals and tubes), where the damage can be directly related to the use of consumables not supplied by Struers.

For information about the available range, see:

- [The Struers Consumables Catalogue](https://www.struers.com) (via <https://www.struers.com>)

# 2 Safety

## 2.1 Intended use

The machine is for use in a professional working environment (e.g. a materialographic laboratory).

AbraPol-30 is for professional semi-automatic or manual materialographic preparation (grinding or polishing) of materials for further materialographic inspection.

The device is designed to be used with Struers consumables specially designed for this purpose and this type of device.

The machine must be operated only by skilled/trained personnel.

<b>Do not use the machine for the following</b>	Preparation (grinding or polishing) of materials other than solid materials suitable for materialographic studies.  The machine must not be used for any type of explosive and/or flammable material, or materials which are not stable during machining, heating or pressure.
<b>Model</b>	AbraPol-30  AbraPol-30 with shift valve

## 2.2 AbraPol-30 safety precautions

### 2.2.1 Read carefully before use

1. Ignoring this information and mishandling of the equipment can lead to severe bodily injuries and material damage.
2. The machine must be installed in compliance with local safety regulations. All functions on the machine and any connected equipment must be in working order.
3. The operator must read the safety precautions and Instruction Manual, as well as relevant sections of the manuals for any connected equipment and accessories.  
  
The operator must read the Instruction Manual and, where applicable, the Safety Data Sheets for the applied consumables.
4. This machine must be operated and maintained only by skilled/trained personnel.
5. The machine must be placed on a safe and stable floor.
6. Make sure that the actual electrical power supply voltage corresponds to the voltage stated on the type plate of the machine. The machine must be earthed (grounded). Always follow local regulations. Always switch off the electrical power supply and remove the plug or power cable before dismantling the machine or installing additional components.
7. Connect the machine to a cold water tap. Make sure that the water connections are leak-proof and that the water outlet is working.
8. Struers recommends that the main water supply is shut off or disconnected if the machine is to be left unattended.
9. Consumables: only use consumables specifically developed for use with this type of materialographic machine. Alcohol-based consumables: follow the current safety rules for handling, mixing, filling, emptying and disposing of alcohol-based liquids.
10. Keep clear of rotating parts during operation. When you perform manual grinding or polishing, be careful not to touch the disc. Do not try to collect a specimen from the tray while the disc is rotating.
11. Wear suitable gloves to protect fingers from abrasives and warm/sharp specimens.
12. When working at machines with rotating parts, take care to prevent clothes and/or hair from being caught by the rotating parts. Appropriate safety clothing must be used.
13. If you observe malfunctions or hear unusual noises, switch off the machine and call technical service.

14. The machine must be disconnected from the electrical power supply before any service. Wait 5 minutes until residual potential on the capacitors is discharged.
15. Do not switch the machine on and off more than once every five minutes. Damage to the electrical components could occur.
16. In case of fire, alert bystanders and the fire brigade. Disconnect the electrical power supply. Use a powder fire extinguisher. Do not use water.
17. Struers equipment must only be used in connection with and as described in the Instruction Manual supplied with the equipment.
18. The equipment is designed to be used only with Struers consumables specifically designed for this purpose and this type of machine.
19. Dismantling of any part of the equipment, during service or repair, should always be performed by a qualified technician (electromechanical, electronic, mechanical, pneumatic, etc.).

## 2.3 Safety messages

Struers uses the following signs to indicate potential hazards.



### **ELECTRICAL HAZARD**

This sign indicates an electrical hazard which, if not avoided, will result in death or serious injury.



### **DANGER**

This sign indicates a hazard with a high level of risk which, if not avoided, will result in death or serious injury.



### **WARNING**

This sign indicates a hazard with a medium level of risk which, if not avoided, could result in death or serious injury.



### **CAUTION**

This sign indicates a hazard with a low level of risk which, if not avoided, could result in minor or moderate injury.



### **CRUSHING HAZARD**

This sign indicates a crushing hazard which, if not avoided, could result in minor, moderate or serious injury.



### **HEAT HAZARD**

This sign indicates a heat hazard which, if not avoided, can result in minor, moderate or serious injury.

### **General messages**



### **Note**

This sign indicates that there is a risk of damage to property, or a need to proceed with special care.



**Hint**

This sign indicates that additional information and hints are available.

## 2.4 Safety messages in this manual

**CAUTION**

Struers equipment must only be used in connection with and as described in the Instruction Manual supplied with the equipment.

**ELECTRICAL HAZARD**

The machine must be earthed (grounded).  
Make sure that the actual electrical power supply voltage corresponds to the voltage stated on the type plate of the machine.  
Incorrect voltage can damage the electrical circuit.

**ELECTRICAL HAZARD****For electrical installations with Residual Current Circuit Breakers**

For AbraPol-30 a residual current circuit breaker Type B, 30 mA is required (EN 50178/5.2.11.1).

**For electrical installations without Residual Current Circuit Breakers**

The equipment must be protected by an insulation transformer (double-wound transformer).

Contact a qualified electrician to verify the solution.

Always follow local regulations.

**CAUTION**

Prolonged exposure to loud noises may cause permanent damage to a person's hearing.  
Use hearing protection if the exposure to noise exceeds the levels set by local regulations.

**CAUTION**

Risk of hand to arm vibration during manual preparation.  
Prolonged exposure to vibration may cause discomfort, joint damage or even neurological damage.

**ELECTRICAL HAZARD**

The pump of the recirculation cooling unit must be earthed (grounded).  
Make sure that the electrical power supply voltage corresponds to the voltage stated on the type plate of the pump.  
Incorrect voltage can damage the electrical circuit.

**CAUTION**

The recirculation tank is very heavy when it is full.



**CAUTION**

The pressure of the cooling fluid supplied to the machine must be max. 2 bar.



**CAUTION**

Do not use the machine with non-compatible accessories or consumables.



**CAUTION**

Keep clear of rotating parts during operation.



**CAUTION**

When working at machines with rotating parts, take care to prevent clothes and/or hair from being caught by the rotating parts.



**CAUTION**

A specimen holder with specimens can be heavy. Do not release the specimen holder until it is secured in the coupling.  
Use working gloves to protect fingers and hands.



**CAUTION**

Avoid skin contact with the cooling fluid additive.



**WARNING**

Do not use the machine with defective safety devices.  
Contact Struers Service.

## 3 Getting started

### 3.1 Device description

AbraPol-30 is a semi-automatic or manual machine for metallographic preparation (grinding/polishing) with a 300 mm or 350 mm diameter preparation disc.

A recirculation cooling unit (option) can be connected for supplying cooling water to the grinding process. If preparation with oxide suspensions is needed, and a recirculation cooling unit has been installed, a shift valve must be included or retrofitted.

The operator selects the grinding/polishing surface, the preparation method, and the cooling fluid/abrasive suspension that will be applied automatically during the process.

Semi-automatic preparation starts by clamping the specimens in the specimen holder and placing them in the machine.

The operator can select manual preparation for special applications. The operator holds the specimens during manual preparation. When manual preparation is used, a special splash guard must be placed before the machine is started.

The operator starts the machine by pressing the Start button on the control panel.

The machine stops automatically. The operator cleans the specimens before the next preparation step or inspection.

We recommend connecting the machine to an exhaust system to remove fumes from the working area.

If the emergency stop is activated, the power to all hazardous moving parts is cut.

## 3.2 AbraPol-30 - overview

### AbraPol-30

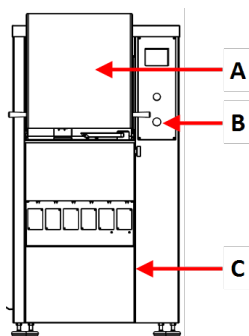

#### Front view - with safety cover

- A Safety cover
- B Emergency stop
- C Cover plate for compartment containing recirculation unit ((option))

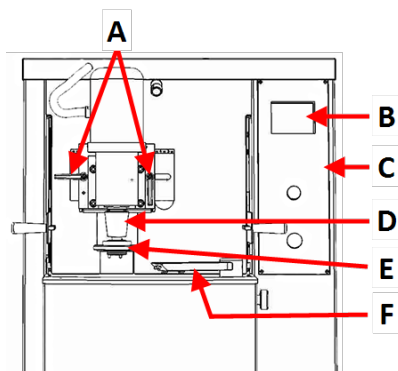

#### Front view - without safety cover

- A Handles for adjusting specimen holder position
- B Display
- C Control panel
- D Motor - Specimen holder
- E Dosing arm
- F Quick coupling - Specimen holder

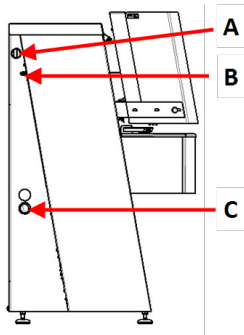

**Side view - left**

- A Connection for exhaust
- B Compressed air inlet
- C Opening for water outlet hose

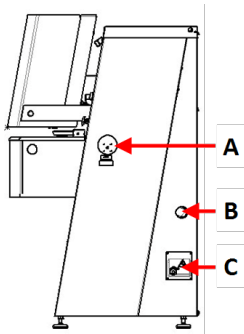

**Side view - right**

- A Electrical power switch
- B Compressed air inlet
- C Electrical power connection

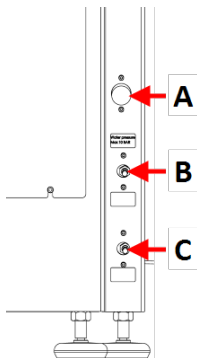

**Rear view**

- A Water inlet
- B Regulation valve for disc cooling
- C Regulation valve for OP flush

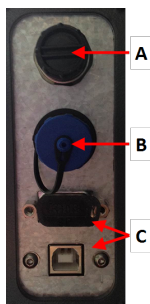

- A AUX connector
- B Beacon connection
- C Service sockets

**Control panel**

See [Control panel functions](#) ► 22.

## 4 Transport and storage

If, at any time after the installation, you have to move the unit or place it in storage, there is a number of guidelines we recommend that you follow.

- Package the unit securely before transportation. Insufficient packaging could cause damage to the unit and will void the warranty. Contact Struers Service.
- We recommend that you use the original packaging and fittings.

### 4.1 Storage

**Note**

We recommend that you keep all original packaging and fittings for future use. Disconnect the unit from the electrical power supply.

- Remove any accessories.
- Clean and dry the unit before storage.
- Place the machine and accessories in their original packaging.

## 5 Installation

### 5.1 Unpack the machine

**Note**

We recommend that you keep all original packaging and fittings for future use.

1. Cut the packing tape on the top of the box.
2. Remove the loose parts.
3. Remove the unit from the box.
4. Unscrew the transport brackets that secure the machine to the pallet.
5. Use a forklift truck to lift the machine from the pallet. Lift the machine from the front.
6. Place the machine on a plane and horizontal floor.
7. Remove the locking pin from the crossbar and remove the bar. Keep the crossbar for use if you need to move the machine.

For details about the weight of this machine, see [Technical data](#) ► 57

**Moving the machine**

To move the machine, use a fork-lift truck and a crossbar.

## 5.2 Check the packing list

Optional accessories may be included in the packing box.

The packing box contains the following items:

Pcs.	Description
1	AbraPol-30 with shift valve/without shift valve
1	Splash guard for manual preparation
1	Inlet hose Diameter: 19 mm/ $\frac{3}{4}$ ", Length: (2 m)
1	Hose for emptying the cooling unit tank
1	Filter gasket
1	Reduction ring with gasket Diameter: $\frac{3}{4}$ " to $\frac{1}{2}$ "
2	Hose clamp. Diameter: 40-60 mm
1	Hose for compressed air. Length: 2 m
1	Hose connection for compressed air. Diameter: $\frac{3}{4}$ "
1	Exhaust hose. Diameter: 50 mm. Length: 2.5 m
1	Fork spanner, 24 mm
1	Instruction Manual set

## 5.3 Power supply



### **ELECTRICAL HAZARD**

The machine must be earthed (grounded).

Make sure that the actual electrical power supply voltage corresponds to the voltage stated on the type plate of the machine.

Incorrect voltage can damage the electrical circuit.



### **ELECTRICAL HAZARD**

#### **For electrical installations with Residual Current Circuit Breakers**

For AbraPol-30 a residual current circuit breaker Type B, 30 mA is required (EN 50178/5.2.11.1).

#### **For electrical installations without Residual Current Circuit Breakers**

The equipment must be protected by an insulation transformer (double-wound transformer).

Contact a qualified electrician to verify the solution.

Always follow local regulations.

### **Procedure**

For specifications see the section Technical data.

1. Open the electrical connection box. **A**
2. Connect a 4-lead or 5-lead cable as shown.
 

PE	Earth (ground)
N	Neutral (not used internally)
L1	Phase
L2	Phase
L3	Phase

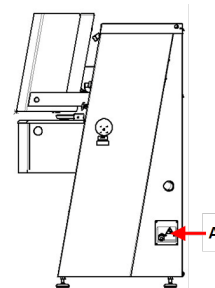

EU cable	
L1	Brown
L2	Black
L3	Black or Grey
Earth (ground)	Yellow/Green
Neutral	Blue

UL cable	
L1	Black
L2	Red
L3	Orange/Turquoise
Earth (ground)	Green (or Yellow/Green)
Neutral	White

The other end of the cable can be fitted with an approved plug or hard-wired into the power supply according to the electrical specifications and local regulations.

## 5.4 Noise

For information on the sound pressure level value, see this section: [Technical data ▶ 57](#)



### CAUTION

Prolonged exposure to loud noises may cause permanent damage to a person's hearing.

Use hearing protection if the exposure to noise exceeds the levels set by local regulations.

## 5.5 Vibration

For information on the total vibration exposure to hand and arm, see this section: [Technical data ▶ 57](#)

**CAUTION**

Risk of hand to arm vibration during manual preparation.  
Prolonged exposure to vibration may cause discomfort, joint damage or even neurological damage.

**How to handle vibration during operation**

Manual preparation may cause vibrations in hand and arm. To lower the vibration, decrease the pressure or use a vibration-reducing glove.

- Limit grinding/polishing operations to a maximum of 10 minutes. Wait for 5 minutes before continuing grinding/polishing.

**5.6 Compressed air supply**

For specifications, see [Technical data ▶ 57](#)

1. Connect the compressed air hose to the compressed air inlet on the machine.
2. Connect the air hose to the compressed air supply.
3. Secure the connections with hose clamps.

**5.7 Connect to an exhaust system**

For specifications, see [Technical data ▶ 57](#).

Struers recommends that the machine is connected to an exhaust system.

1. Connect a 52 mm pipe to the exhaust outlet on the machine.
2. Connect the other end of the pipe to the exhaust system.

**5.8 Connecting to the water supply**

If the machine is used without a recirculation unit, it must be connected directly to the main water supply in these cases:

- if an OP-pump is mounted
- if disc cooling is required

**Water from the main water supply**

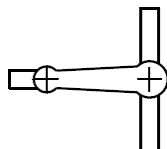

**Water from the recirculation unit (option)**

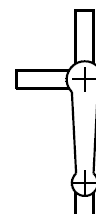



**Procedure**

1. Connect the pressure hose to the water inlet hose on the back of the machine:
  - Insert the filter gasket in the coupling nut with the flat side against the pressure hose.
  - Tighten the pressure nut.
2. Connect the other end of the pressure hose to the main water outlet
  - Mount the reduction ring with gasket on the cold water outlet if necessary.
  - Insert the gasket.
  - Tighten the coupling nut.

**Adjusting the water flow**

- If needed, use the water valve to adjust the water flow during grinding/polishing. (A)

**5.9 Connecting to the waste water outlet**

1. The machine is delivered with a water outlet hose.
2. Lead the water outlet hose out of the machine through one of the openings in the sides of the machine.
3. Make sure that the hose slopes downward towards the waste water drain throughout its entire length. If needed, shorten the hose.

**5.10 Connect the recirculation unit (option)**

To ensure optimal cooling, mount a recirculation unit on the machine.

**Note**

Before you connect the recirculation unit to the machine, you must prepare it for use. See the Instruction Manual for this unit.

**ELECTRICAL HAZARD**

Make sure that the electrical power supply voltage corresponds to the voltage stated on the type plate of the pump. Incorrect voltage can damage the electrical circuit.

### Filling the recirculation tank

1. Before you fill the tank, make sure that there is room under the machine for the recirculation unit to slide in easily. If this is not the case, use the adjustable feet to adjust the height of the machine.
2. Make sure that the recirculation unit is placed correctly under the machine:

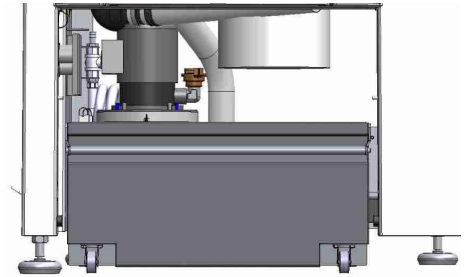

- The wheels of the unit must be in line with the sides of the compartment so that you can move the unit into position without having to wiggle it from side to side.
- The pump must be placed on the left hand side and close to the rear end of the recirculation unit.



**Note**

To prevent corrosion, Struers recommends using a Struers additive in the cooling water. For more information, see the additive container.

3. Line the tank with a clean plastic liner.



**CAUTION**

The recirculation tank is very heavy when it is full.



**Note**

Do not overfill the tank.  
Avoid spilling when you move the tank.

4. Fill up the tank with cooling fluid. Make sure that the water/additive ratio is correct.

### Connecting the unit to the machine

1. Connect the water inlet hose to the quick coupling on the recirculation pump.

- A** Electrical power socket - not shown
- B** Water inlet hose - to machine
- C** Recirculation pump
- D** Quick coupling - on pump

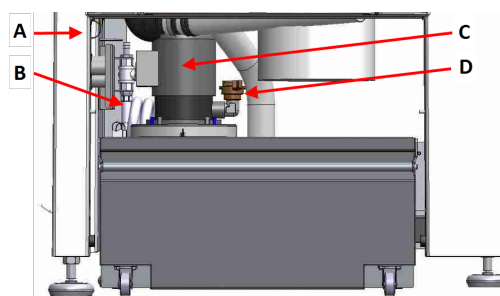

2. Insert the water outlet hose from the machine into the large hole of the filter unit. If needed, shorten the hose.
3. Connect the cable from the recirculation pump to the electrical power socket of the recirculation unit inside the compartment.
4. Make sure that the direction of the flow is as stated with an arrow on the pump. If the direction is incorrect, switch two of the phases:
  - EU cable: switch two of the phases.
  - UL cable: switch phases L1 and L2.
5. Push the unit into place in the compartment under the machine.

## 5.11 Connecting an external recirculation unit (option)

1. Guide the water outlet hose through the opening on the left or right side of the machine to the recirculation unit.
2. Connect the water outlet on the pump to the water inlet hose.



#### **ELECTRICAL HAZARD**

Make sure that the electrical power supply voltage corresponds to the voltage stated on the type plate of the pump.  
Incorrect voltage can damage the electrical circuit.



#### **CAUTION**

The pressure of the cooling fluid supplied to the machine must be max. 2 bar.

3. Connect the cable from the external pump to the electrical power socket of the recirculation unit inside the compartment.

Wiring: For specifications see the section Technical data.

**Note**  
 If you are using the AUX connection, contact Struers Service more information on the connection and the required flow.

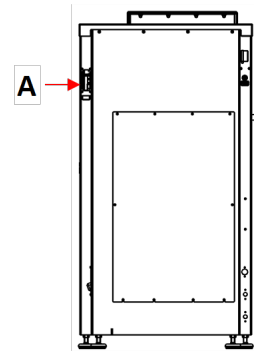

4. Connect the external pump control to the AUX connection on the rear of the machine. **A**

## 5.12 Adjusting disc cooling and OP-flushing

You can set the level of disc cooling and flushing time in the software

If you need to adjust the rate of disc cooling:

1. Loosen the locknut and turn the regulator screw as needed.
2. Tighten the locknut.

**Hint**  
 If needed, use the throttle valves to adjust the maximum water flow for disc cooling and flushing after OP.  
 The level of disc cooling and flushing time is set in the software. See [Options ▶ 31](#).

## 5.13 The dosing pump units

You can configure up to 6 pumps:

- A** DP-pumps  
Up to 6 pumps, positions 1 to 6 (shown in the red box)
- B** OP-pumps  
Up to 2 pumps, positions 5 and 6 (shown in the green box)

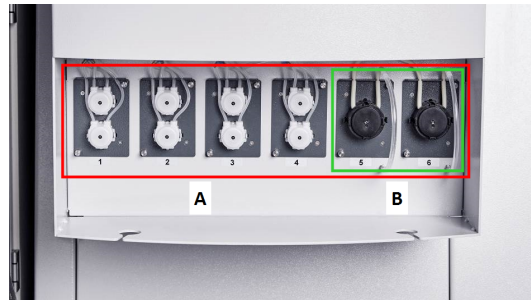

### Mounting the dosing pump units

1. Remove the cover plates.
2. Insert the pump units in the correct position in the bottle units and push until they are firmly secured.
3. Secure the units with the attached screws.

**OP pumps**

1. Push the connector disc inwards and remove the bottle plug from the OP flush water connector.
2. Lead the short tube from the OP pump, press the connector disc inwards and insert the tube into the connector.

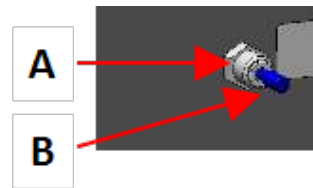
**Calibrating the pumps**

See [Calibrating the pumps](#) ► 50.

**5.13.1 Placing bottles in the dosing unit**

1. Exchange the bottle cap with the cap supplied with the DP/OP pump unit.
2. Place the bottles in the bottle units and connect the tubes to the nipples on top of the caps.
  - DP-pump: Connect the long piece of tube (attached to the y-connector) to the connector on the bottle cap.
  - OP-pump: Connect the long piece of tube to the connector on the bottle cap.
3. Enter the bottle details in the **Bottle configuration** menu to make them available for preparation methods. See [Bottle configuration](#) ► 28

**Hint**

If needed, you can extend the tubes and lead them through the holes in the bottle unit to reach larger containers placed on the floor.

**6 Operate the device****CAUTION**

Do not use the machine with non-compatible accessories or consumables.

## 6.1 Control panel functions







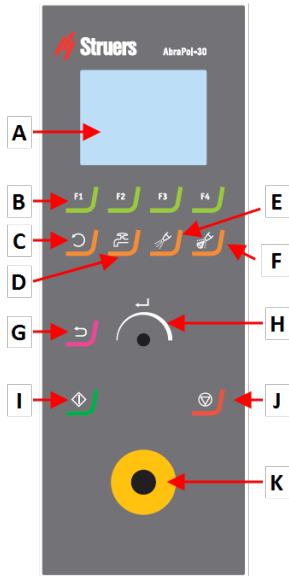







### CAUTION

Keep clear of rotating parts during operation.  
When working at machines with rotating parts, take care to prevent clothes and/or hair from being caught by the rotating parts.

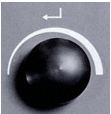

- A Display
- B Function keys - F1 to F4
- C **Disc rotation** function
- D Water function
- E Lubricant function
- F Abrasive function
- G **Back** function
- H Turn/push knob knob
- I Start button
- J Stop button
- K Emergency stop button

Button	Function
 to 	<b>Function key</b> <ul style="list-style-type: none"> <li>Press this button to activate controls for various purposes. See the bottom line of the individual screens.</li> </ul>
	<b>Disc rotation</b> <ul style="list-style-type: none"> <li>Starts rotation of the disc (<b>Spin</b> function).</li> <li>Press this button again to stop the rotation.</li> </ul>
	<b>Water</b> <ul style="list-style-type: none"> <li>Activates the water flow.</li> <li>Remember to adjust the flow on the water tap.</li> </ul>

Button	Function
	<b>Lubricant</b> <ul style="list-style-type: none"> <li>For manual dosing of lubricant.</li> </ul>
	<b>Abrasive</b> <ul style="list-style-type: none"> <li>For manual dosing of abrasive.</li> </ul>
	<b>The Turn/push knob knob</b> <ul style="list-style-type: none"> <li>Turn the <b>Turn/push knob</b> knob to move the focus on the screen and change steps and setting. Press to toggle when only 2 options are available.</li> <li>Press the <b>Turn/push knob</b> knob to select a function or save a selected setting.</li> </ul>
	<b>Back</b> <ul style="list-style-type: none"> <li>Press this button to return to the previous screen or to cancel functions/changes.</li> </ul>
	<b>Start</b> <ul style="list-style-type: none"> <li>Starts the preparation process.</li> </ul>
	<b>Stop</b> <ul style="list-style-type: none"> <li>Stops the preparation process.</li> </ul>
	<b>Emergency stop</b> <div style="border: 1px solid blue; padding: 10px; margin-top: 10px;"> <p><b>Note</b>   Do not use the emergency stop for operational stop of the machine during normal operation. Before you release the emergency stop, investigate the reason for activating the emergency stop and take any necessary corrective action.</p> </div>

## 6.2 The display



**Note**  
The screens shown in this manual may differ from the actual screens in the software.

The display is the user-interface to the software.

When you switch on the machine, the display shows the configuration and the version of the installed software.

The display is divided into some main areas. See this example.

**A Title bar**

The title bar shows the function you have selected.

**B Information fields**

These fields show information about the selected function. In some fields you can select and change the value.

**C Function key options**

The functions shown depend on the screen that is displayed.

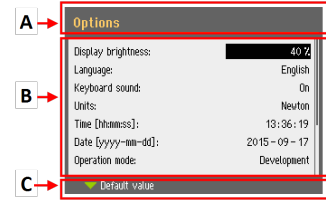

**Sound**

**Short beep**

A short beep, when you press a key, indicates that the selection is confirmed.

You can enable or disable the beep: select **Configuration**.

**Long beep**

A long beep, when you press a button, indicates that the key cannot be activated at the moment.

You cannot disable this beep.

**Standby mode**

To increase the lifetime of the display, the back-light is dimmed automatically if the machine has not been used for a while. (10 min)

- Press any key to re-activate the display.

**6.2.1 Navigating in the display**



**The Turn/push knob knob**

Use this knob on the control panel to select menu items.

- Turn the knob to select a menu, a method group or to change a value.
- Press the knob to enter a field or activate the selection.
- Turn the knob to increase or decrease the numeric value, or to toggle between two options.
  - If there are only two options, press the knob to toggle between the two options.
  - If there are more than two options, a pop-up box is shown.

**The Back button**



Use this button on the control panel to return to previous functions or values.

- Press the button to return to the main menu.
- Press the button to return to the last function or value.
- Press the button to cancel changes.



## 6.2.2 Main menu

From the **Main menu** screen you can choose between the following options:



- **Automatic preparation**



- **Manual preparation**

You can also access the maintenance and configuration screens.



- **Maintenance**



- **Configuration**

## 6.2.3 Changing settings and text

### Changing text

To change a text value, select the field for entering the text.

1. Press the **Turn/push knob** knob to activate the text editor.
2. If needed, use the **Upper case/Lower case** arrow at the bottom of the screen to switch between upper case and lower case letters.
3. Enter the desired text.
4. Navigate to select **Save & Exit**.
5. Press the **Turn/push knob** knob to exit the screen.



### Change the settings

To change a setting, select the field for changing the setting.

1. Turn the **Turn/push knob** to go to the field where you wish to change the setting.
2. Press the **Turn/push knob** to enter the field.
  - **More than two options:**  
Turn the **Turn/push knob** to scroll up or down in a list of values.
  - **Two options:**  
Press the **Turn/push knob** to toggle between the options.
3. Navigate to select **Save & Exit**.
4. Press the **Turn/push knob** to exit the screen.

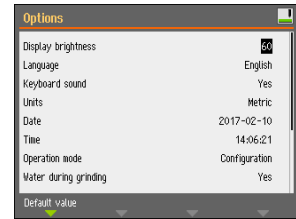

## 6.2.4 Software settings

### Start-up - the first time

For instructions on how to navigate in the display, see [Navigating in the display ▶ 24](#).

#### Select language

1. Select the language you wish to use. If needed, you can change the language at a later date.
  - From the **Main menu** select **Configuration** > **Options** > **Language**.



2. **Date**  
You will be prompted to set the date.



3. **Time**  
You will be prompted to set the time.



**Select disc size** 300 mm/350 mm

You will be prompted to select the disc size.

### Start-up - daily operation

When you switch on the machine, the screen that was shown when the machine was switched off is shown just after the start-up screen.

## 6.3 Configuration

You can set a number of settings and parameters.

1. From the **Main menu** select **Configuration**.

2. From the **Configuration** menu, select:



- **Bottle configuration**. See [Bottle configuration ▶ 28](#).



- **Specimen holder positioning**. See [Adjusting the specimen holder position ▶ 38](#).



- **User defined consumables** for setting specific parameters.



- **Options** for general settings.

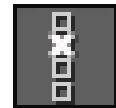

### 6.3.1 Operation mode

#### User levels

You can select three different user levels as operation mode.

Operation mode	Preparation	Change the settings	Configuration functions
<b>Production</b>	You can select and view settings.	You can select and view methods.	You can edit some settings.
<b>Development</b>	You can select, view and edit settings.	You can select, view and edit methods.	You can edit some settings.
<b>Configuration</b>	You can select, view and edit settings.	You can select, view and edit methods.	You can edit all settings.

#### Change operation mode

To change the operation mode, do the following:

1. From the **Main menu** select **Configuration > Options > Operation mode**.
2. Enter the pass code. See [New pass code ▶ 28](#).

3. When the **Select operation mode** dialog is shown, select the desired operation mode and confirm your selection.

### 6.3.2 New pass code

When you access the **Operation mode** menu, you will be prompted to enter a pass code. The default pass code is '2750'.

#### Changing the pass code

You can change the pass code from the **Operation mode** menu.



**Note**  
Make a note of the new pass code.

To change the pass code, do the following:

1. From the **Main menu** select **Configuration > Options**.
2. Select the field for entering the pass code.
3. When the **Enter pass code** dialog is shown, enter the current pass code. The default pass code is '2750'.
4. Change the pass code and confirm your selection.

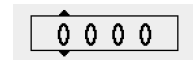

### 6.3.3 Bottle configuration



**Hint**  
The different suspensions and lubricants used must always be configured so that the correct suspension or lubricant is used during the preparation.

To configure the bottles to be used for lubricants and suspensions, do the following:

1. From the **Main menu** select **Configuration > Options > Bottle configuration**.  
1 to 6 configuration options are shown depending on the number of pump units and pumps that are installed.  
You can configure positions 5 and 6 for OP pumps.
2. Press **F1** to select the **Pump configuration** screen.
3. Select the pump type you wish to configure: **DP pump** or **OP pump** (with water connection).
4. Press **F4** to return to the **Bottle configuration** screen.
5. Select the first bottle.
6. Select **Suspension, Lubricant** or **None** (if no dosing bottle is connected).
7. If a bottle with diamond suspension is connected to pump 1, select **Suspension**.
8. Select **Type**.
9. Select the **Select suspension type** menu.
10. Select the correct type and grain size of the suspension you are using.

11. Repeat the procedure for all of the following pumps/bottles until all bottles are configured correctly.
12. Press **Back** until the **Main menu** screen is shown.



### 6.3.4 User defined consumables

From the **User defined consumables** menu you can access the following screens:



- **Surface configuration**



- **Suspension configuration**



- **Lubricant configuration**

#### User surface configuration

1. From the **Configuration** menu, select **User surface configuration**.
2. In the **Surface name** column you can select an item. You can rename or delete this item.



3. To return to the **Configuration** menu, press **Back**



#### Suspension configuration

You can define up to 10 new user-defined suspensions.

 **Hint**  
Configure all-in-one suspensions as lubricants. If they are configured as suspensions, the dosing level will not be high enough.

1. From the **Configuration** menu, select **Suspension configuration**.



2. In the **Suspension name** column you can select an item. You can rename or delete this item.
3. Select the corresponding field in the **Abr. type** column.
4. Select the abrasive type. Make sure that you select the correct type.

You can choose between:

- **Diamond**
- **Oxide**

5. To return to the **Configuration** menu, press **Back**



### Lubricant configuration

You can define up to 10 new user-defined lubricants.

 **Hint**  
Configure all-in-one suspensions as lubricants. If they are configured as suspensions, the dosing level will not be high enough.

1. From the **Configuration** menu, select **Lubricant configuration**.



2. In the **Lubricant name** column you can select an item. You can rename or delete this item.
3. Select the corresponding field in the **Lubricant type** column.

4. Select the lubricant type. Make sure that you select the correct type.
  - **1 DP-Lubricant, water based**  
Select this option if the lubricant contains water.
  - **2 DP-Lubricant, alcohol based**  
Select this option if the lubricant is water-free and is to be used for preparing water-sensitive materials.
5. To return to the **Configuration** menu, press **Back**



### 6.3.5 Options

From the **Options** menu you set up general options for e.g. display, language, disc size, etc.

- If needed, you can reset some settings to their factory default value:  
Press function key **F1** when the value is highlighted.



Option	Setting
<b>Display brightness</b>	You can adjust the display to make it easier to view.
<b>Language</b>	Select the language you wish to use in the software.
<b>Keyboard sound</b>	<ul style="list-style-type: none"> <li>• <b>Yes:</b> When you press a button on the control panel, a sound is heard.</li> <li>• <b>No:</b> No sound is heard.</li> </ul>
<b>Units</b>	Show the removal rate settings in one of the following units: <ul style="list-style-type: none"> <li>• <b>Newton - <math>\mu\text{m}</math></b> (Metric)</li> <li>• <b>Lbf - mils</b> (Imperial)</li> </ul>
<b>Select disc size</b>	Select the disc size diameter: <ul style="list-style-type: none"> <li>• 300 mm</li> <li>• 350 mm</li> </ul>
<b>Date</b>	Set the date.
<b>Time</b>	Set the time
<b>Operation mode</b>	See <a href="#">Operation mode</a> ► 27.

Option	Setting								
<b>Auto continue mode</b>	You can set the machine to automatically continue to the next step in a method, as long as the consumables used are the same.								
	<table border="1"> <thead> <tr> <th data-bbox="608 338 1002 394">Setting</th> <th data-bbox="1002 338 1401 394">Definition</th> </tr> </thead> <tbody> <tr> <td data-bbox="608 394 1002 483"><b>Off</b></td> <td data-bbox="1002 394 1401 483">The machine pauses between each step.</td> </tr> <tr> <td data-bbox="608 483 1002 678"><b>Equal cons. except SiC</b></td> <td data-bbox="1002 483 1401 678">The machine automatically continues to the next step, but pauses when grinding with SiC Paper, which must be changed between the steps.</td> </tr> <tr> <td data-bbox="608 678 1002 779"><b>Always</b></td> <td data-bbox="1002 678 1401 779">The machine automatically continues to the next step.</td> </tr> </tbody> </table>	Setting	Definition	<b>Off</b>	The machine pauses between each step.	<b>Equal cons. except SiC</b>	The machine automatically continues to the next step, but pauses when grinding with SiC Paper, which must be changed between the steps.	<b>Always</b>	The machine automatically continues to the next step.
	Setting	Definition							
	<b>Off</b>	The machine pauses between each step.							
<b>Equal cons. except SiC</b>	The machine automatically continues to the next step, but pauses when grinding with SiC Paper, which must be changed between the steps.								
<b>Always</b>	The machine automatically continues to the next step.								
<b>Flushing time after OP step</b>	20 - 60 seconds								
<b>SynchroSpeed</b>	<p>This setting synchronizes the speed of the disc and the specimen holder. If you change the speed of one of these parameters, the speed of the other parameter will be changed automatically.</p> <p>You can use this setting within the range of 50 - 300 rpm.</p> <ul style="list-style-type: none"> <li>• <b>Yes:</b> Activates synchronized speed change.</li> <li>• <b>No:</b> Deactivates synchronized speed change.</li> </ul>								
<b>Cover opening delay</b>	0 - 60 seconds								
<b>AUX. Off delay after process stop</b>	0 - 180s  This function is used when auxiliary equipment is connected via the AUX panel on the machine.  If an exhaust system is connected via the AUX. connection, it will continue extracting air for 30 seconds after the process has stopped.								
<b>Shift valve installed</b>	<ul style="list-style-type: none"> <li>• <b>Yes:</b> When a shift valve is installed.</li> <li>• <b>No:</b> When a shift valve is not installed.</li> </ul>								
<b>Beacon installed</b>	<ul style="list-style-type: none"> <li>• <b>Yes:</b> When a beacon is installed.</li> <li>• <b>No:</b> When a beacon is not installed.</li> </ul>								



## 6.4 Preparation methods

The software includes 10 Metalog Guide methods, which you can use to set up your preparation methods.

These methods have been developed according to the following standard:

300 mm	6 specimens with a diameter of 30 mm clamped in a specimen holder with a diameter of 160 mm.
350 mm	8 specimens with a diameter of 40 mm clamped in a specimen holder with a diameter of 200 mm.

You can save these methods under a name of your choice, and adjust them to suit your requirements.

### Creating a preparation method

You can create a preparation method in several ways:

- Create a preparation method  
To create a preparation method, see [Creating a preparation method ▶ 33](#).
- Change a preparation method and save it under another name  
To change a preparation method, see [Changing a preparation method ▶ 35](#).

### Storing capacity

You can store a maximum of 200 methods in up to 10 groups. Each group can contain up to 20 methods.

### 6.4.1 Creating a preparation method

You can create an entire preparation method step by step.

1. From the **Main menu** screen, select **Automatic preparation** or **Manual preparation**.
2. Select **New group > New method**.
3. In the **New method - Step No. 1** screen, change the settings needed for the preparation method.









An asterisk (\*) next to the name of the preparation method name indicates that there are unsaved changes.







4. When you have changed the required settings, press **F3**.  
**New method - Step No. 2** is shown.
5. When you have created and changed the required preparation steps, save the preparation method:
6. Press **F4**.
  - **Save method**  
Save the method with the current name and current method group.
  - **Save method as**  
Specify a new method group and a new method name.



## 6.4.2 Settings

You can change the settings for each step in a preparation method.

Setting	
	<p><b>Surface type/Surface</b></p> <ul style="list-style-type: none"> <li>Select surface type and surface.</li> </ul>
	<p><b>Suspension type/Suspension</b></p> <ul style="list-style-type: none"> <li>Select the suspension.</li> </ul>
	<p><b>Lubricant</b></p> <ul style="list-style-type: none"> <li>Select the lubricant.</li> </ul> <p>All-in-one suspensions are set up as lubricants.</p>
	<p><b>Level</b></p> <ul style="list-style-type: none"> <li>Select the dosing level. See <a href="#">Setting dosing levels ▶ 37</a>.</li> </ul>
	<p><b>Force</b></p> <ul style="list-style-type: none"> <li>Select the force. 50 to 700 N.</li> </ul>
	<p><b>Preparation mode</b></p> <p>The following modes are available:</p> <ul style="list-style-type: none"> <li> <p> <b>Removal</b></p> <p>Select a specific amount of material to be removed from the specimens. 50 – 5000 µm.</p> </li> <li> <p> <b>Time</b></p> <p>Select a specified length of time for the process. 5 seconds - 10 minutes</p> </li> </ul>

	<p><b>Disc rotation: Speed</b></p> <ul style="list-style-type: none"> <li>Select the speed of the disc. 40 – 600 rpm.</li> </ul> <p>If <b>SynchroSpeed</b> is set to <b>Yes</b>, the max. setting is 300 rpm.</p> <div style="border: 1px solid blue; padding: 10px; margin-top: 10px;"> <p><b>Hint</b></p> <p> <b>300 rpm on disc and specimen mover</b> If the rotation speed of both the disc and the specimen mover is set to 300 rpm, we recommend the following:</p> <ul style="list-style-type: none"> <li>Use disc cooling.</li> <li>Pre-dose sufficiently if you work with new preparation surfaces.</li> <li>Use a 200 mm specimen holder on a 350 mm surface to adequately distribute the lubricant and abrasive.</li> <li>Do not use alcohol-based lubricants as they will evaporate too quickly.</li> </ul> </div>
	<p><b>Specimen holder: Speed</b></p> <ul style="list-style-type: none"> <li>Select the speed of the specimen holder. 50 – 300 rpm</li> </ul>
	<p><b>Specimen holder: Direction</b></p> <ul style="list-style-type: none"> <li>Select the direction of the specimen holder: <ul style="list-style-type: none"> <li>  <ul style="list-style-type: none"> <li><b>Co-rotation</b> Recommended for the best preparation result and most uniform polishing.</li> </ul> </li> <li>  <ul style="list-style-type: none"> <li><b>Counter-rotation</b> Recommended for polishing with oxide polishing suspensions to keep the suspension on the polishing cloth.</li> </ul> </li> </ul> </li> </ul>

### 6.4.3 Changing a preparation method

You can change an existing preparation method.

If you wish to change a Struers Metalog Guide methods, you must save the method under another name and in a different group in the User Methods database before you can make any changes.

- Select the preparation method you wish to change.
- Go through the different preparation steps and make the changes as needed.
- Press **F4**.
  - **Save method**  
Save the method with the current name and current method group.
  - **Save method as**  
Specify a new method group, if needed, and a new method name.



#### 6.4.4 Locking a preparation method

You can lock a preparation method to prevent it from being changed or deleted.

1. In the **Group** screen, select the method you wish to lock.
2. Press **F1: Lock method**.



3. You will be prompted to confirm that you wish to lock the method.



4. The symbol in front of the method name shows that the method is locked.  
If you make changes to this preparation method, you must save the method under another name.



#### 6.4.5 Copying a preparation step

You can copy a preparation step from one preparation method to another.

1. Select a method that includes the preparation step you wish to copy.
2. Select the preparation step you wish to copy.
3. Press **F1: Copy step**.
4. Select the preparation method where you wish to insert the preparation step.
5. Select the preparation step that will follow the new preparation step.
6. Press **F2: Insert step**.  
The new preparation step is inserted before the highlighted step.



7. Press **F4: Save method**.  
If the preparation method is locked, select **Save method as**



#### 6.4.6 Deleting a preparation step

You can delete a preparation step from a preparation method.

1. Select the method that includes the preparation step you wish to delete.
2. If needed, unlock the preparation method.
3. Press **F3: Delete step**.
4. You will be prompted to confirm deleting the preparation step.



5. Press **F4: Save method**.



### 6.4.7 Setting dosing levels

When suspensions and/or lubricants are used in a preparation step, you must first select the type of suspension or lubricant, and then the dosing level.



For **Level** you can set two values: e.g. 2/7 (pre-dosing/dosing).

Option	Pre-dosing	Dosing	Increment
Dosing level	0 - 10	0 - 20	1

#### Example



#### The pre-dosing level [e.g. 2]

This value is the pre-dosing level, the amount of suspension or lubricant which is applied to the surface before the actual preparation step is started.

This lubricates the surface to prevent damage from occurring if the specimens were to run on a dry surface.

Applicable values depend on the frequency of use and surface types. For frequently used surfaces, use a lower value than for surfaces used infrequently.



#### The dosing level [e.g. 7]

This value is the dosing level throughout the preparation. This level is set according to the surface types: soft, napped polishing cloths require more lubricant than hard, flat cloths or fine grinding discs.

Fine grinding discs require a lower dosing level of abrasive than polishing cloths.

## 6.5 The specimen holder

### 6.5.1 Clamp and level the specimens

The specimens must be evenly distributed in the specimen holder. They must be of approximately the same size and weight.

The specimen holder must be balanced. If it is not, it will result in excess vibration during grinding.

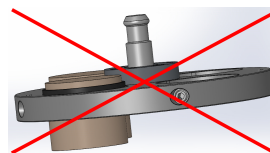
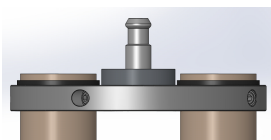

1. Place at least three specimens symmetrically around the center of the specimen holder so that you achieve an even and balanced rotation.

2. Tighten the screws carefully to clamp the specimens in place.
3. Always choose a length of screw that leaves as little as possible of the screw projecting from the specimen holder and that uses the whole length of the thread inside the specimen holder.
4. Make sure that all specimens are securely fixed.



**Hint**

If you are using a Uniforce leveling device, see the instructions manual for this device.

### 6.5.2 Inserting or removing the specimen holder



**CRUSHING HAZARD**

A specimen holder with specimens can be heavy. Do not release the specimen holder until it is secured in the coupling.  
Use working gloves to protect fingers and hands.

#### Inserting the specimen holder

1. Place the specimen holder under the quick coupling and support it with your fingers.
2. Press and hold down the flange of the column while you guide the pressure tap of the specimen holder into the coupling.
3. Release the flange carefully.
4. Rotate the specimen holder until the three pins engage with the corresponding holes.
5. Make sure that the specimen holder is securely fixed in the coupling.



#### Removing the specimen holder

1. Support the specimen holder with your fingers.
2. Press and hold down the flange while you press the specimen holder slightly upwards. At the same time, use the heel of your hand to press and hold down the flange.
3. Support the specimen holder with one hand while you lower it to release it from the coupling.
4. Release the flange and remove the specimen holder.

### 6.5.3 Adjusting the specimen holder position

To obtain the best preparation results, you must adjust the position of the specimen holder in relation to the preparation disc.

1. Release the handles located on each side of the specimen holder motor.  
The handles are spring-loaded to increase the range of movement.
2. Pull the handle outwards to disengage the torque moment on the screw.
3. Move the specimen holder motor sideways manually until you have found the correct position. You can read the eccentricity on the scale on the specimen holder motor.
4. Turn the handle clockwise (or counter-clockwise) to the desired position, then release the handle to re-engage the torque moment on the screw.
5. Tighten the screws again.

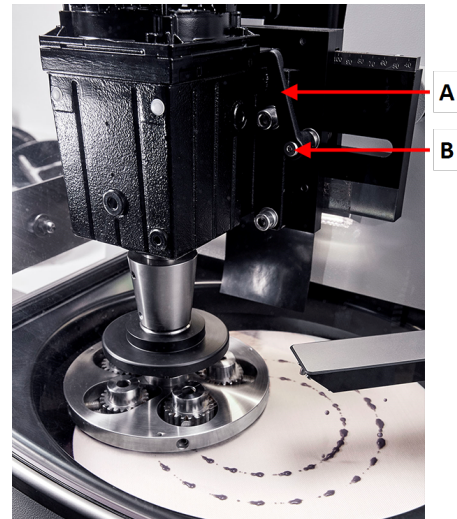

**A** Handle  
**B** Screw

### Further adjustments

For more precise adjustments, use a special function in the **Configuration** menu.

6. From the **Main menu** select **Configuration > Specimen holder positioning**.
7. Press **F1** to move the specimen holder down. The specimen holder moves down at the lowest possible force without rotation, and you can now position the holder as precisely as required.
8. Press **F1** again to move the specimen holder up.



## 6.6 The preparation process

### 6.6.1 The splash guard

- Manual preparation**
- The splash guard for manual preparation is supplied with the machine.

### 6.6.2 Start the preparation process

1. Make sure that the splash ring is in place.
2. If needed, press **Back** until the **Main menu** screen is shown.
3. Select **Struers methods** in the **Main menu**.
4. Select **Automatic preparation**.
5. Select the **Struers Methods** menu.
6. Select the method you wish to use.
7. Place the required preparation surface on the MD-Disc.
8. Insert the specimen holder into the coupling.
9. Close the cover of the machine.
10. Press the **Start** button.



#### Recirculation (option)

The recirculation pump starts automatically when the process is started.

#### The preparation process

The display shows the status of the process as shown in this example.

The green bar denotes the step currently running.

	A	B	C	D
1	SIC-Pap #220		Water	1:50
2	Mol	DPP 6µm	DP-Blue	2:00 mm:ss
3	Dac	DPP 3µm	DP-Blue	2:00 mm:ss

- A Surface**
- B Suspension**
- C Lubricant**
- D Time/µ.** The time shown in the green bar is the time remaining.

### 6.6.3 Stopping the preparation process

The process stops automatically when the set time has elapsed.

If needed, you can stop the process earlier.

#### Stopping the machine

- Press the **Stop** button.



The process is paused.

To stop the process completely:



- Press the **Stop** button again







The specimen holder returns to its initial position.

#### 6.6.4 The spin function

Only use the spin function to rotate the preparation disc at high speed

- to remove water from the surface of the disc.
- to remove water from an MD-Disc or a SiC Foil/SiC Paper before you remove it,
- to dry an MD-Disc or an MD-Chem cloth

##### Procedure

At 100 rpm	
1. To start the spin function, press the <b>Disc rotation</b> button. It rotates at 100 rpm.	
2. To stop the spin function, press the <b>Disc rotation</b> button again.	
At 150 rpm	
1. To start the spin function, press and hold the <b>Disc rotation</b> button. It rotates at 150 rpm.	
2. To stop the spin function, press the <b>Disc rotation</b> button again.	
At 600 rpm	
1. Close the cover of the machine.	
2. To start the spin function, press and hold the <b>Disc rotation</b> button. It rotates at 600 rpm.	
3. To stop the spin function, release the <b>Disc rotation</b> button.	

# 7 Maintenance and service

Proper maintenance is required to achieve the maximum up-time and operating lifetime of the machine. Maintenance is important in ensuring continued safe operation of your machine.

The maintenance procedures described in this section must be carried out by skilled or trained personnel.

## Safety Related Parts of the Control System (SRP/CS)

For specific safety related parts, see the section "Safety Related Parts of the Control System (SRP/CS)" in the section "Technical data" in this manual.

## Technical questions and spare parts

If you have technical questions or when you order spare parts, state serial number and voltage/frequency. The serial number and the voltage are stated on the type plate of the machine.

## 7.1 General cleaning

To ensure a longer lifetime for your machine, we strongly recommends regular cleaning.



**Note**

Do not use a dry cloth as the surfaces are not scratch resistant.



**Note**

Do not use acetone, benzol or similar solvents.

### If the machine is not to be used for a longer period of time

- Clean the machine and all accessories thoroughly.

## 7.2 Daily

- Clean all accessible surfaces with a soft, damp cloth.

### Recirculation unit

See the manual supplied with the specific equipment.

- Check the level of the cooling fluid after 8 hours of use, or at least once a week. If needed, fill up the tank with more cooling fluid.
- Check the filters. Clean the filters, if needed.

### 7.2.1 Checking the recirculation tank

1. Check and, if necessary, change the cooling fluid.

**Note**

If the cooling fluid is contaminated by algae or bacteria, replace the cooling fluid immediately.

2. If the pump cannot reach the cooling fluid, refill the unit.
3. Change the cooling fluid if it is dirty. See [Changing the cooling fluid](#) ► 45.

## 7.3 Weekly

Clean the machine regularly to avoid damage caused by abrasive grains or metal particles.

1. Clean all painted surfaces and the control panel with a soft damp cloth and common household detergents. For heavy duty cleaning, use a heavy duty cleaning agent such as Solopol Classic.
2. Cleaning the surfaceClean the cover with a soft damp cloth and a common household anti-static window cleaner.

**Note**

Make sure that no detergent or cleaning agent is flushed into the cooling unit tank, as this will cause excess foaming.

### Recirculation unit

See the manual supplied with the specific equipment.

- Clean the recirculation unit.
- Clean the recirculation unit tank.
- Fill up the recirculation unit tank.

### 7.3.1 Cleaning the bowl

To clean the bowl, use the bowl cleaning function.

1. From the **Maintenance** menu select **Cleaning of bowl**.
2. Select the cleaning time.



3. If needed, select disc rotation.



4. If needed, select additional cleaning water.



5. Press **F1** to start the cleaning process.



 **Note**  
The additional water for cleaning comes from the dosing arm.

### 7.3.2 Cleaning the tubes

Clean the tubes every week or every time you change or replace the bottles. This will prevent lubricant/suspension left in the tubes from affecting the preparation procedures.

- From the **Maintenance** menu select **Cleaning of tubes**.

#### Cleaning selected tubes

1. One by one, select the bottles you wish to clean. The status in the **Select** column must be set to **Yes**
2. Press **F1** to start the cleaning process. A pop-up message appears.
3. Follow the instructions in the pop-up message.



When the cleaning process is finished, the status in the Status column for the clean bottle will change to **Clean**.

#### Cleaning used tubes

All tubes in use must be cleaned from regularly.

1. In the **Cleaning of tubes** screen, press **F4** to select all used tubes.
2. To start the cleaning process, press **F1**.
3. Follow the instructions in the pop-up message.



When tube cleaning is finished, the status in the Status column for all bottles will change to **Clean**.

## 7.4 Monthly

### Recirculation unit

See the manual supplied with the specific equipment.

- Clean the recirculation unit.
- Replace the cooling fluid at least once a month.

 **Note**  
Replace the cooling fluid immediately if you notice that it is infected by algae or bacteria.

### 7.4.1 Cleaning the recirculation unit

1. Clean the recirculation tank and the connected tubes thoroughly.

2. If you use a soap solution to clean the bowl or the recirculation tank, rinse with clean water before filling the recirculation tank.

**Note**

If the cooling fluid is contaminated by algae or bacteria, replace the cooling fluid immediately.

3. If the cooling water has been infected with bacteria or algae, clean the tank and tubes with a suitable antibacterial disinfectant.
4. Clean the static filter: Remove it and rinse it with water.

## 7.4.2 Changing the cooling fluid

**Note**

The cooling unit fluid contains additive and grinding residue and you must not dispose of it into the waste water drain. Cooling fluid must be disposed of in compliance with local safety regulations.

### Empty the recirculation tank

1. Remove the recirculation tank from the compartment under the machine.
2. Disconnect the water inlet hose from the pump and connect the extra piece of hose (supplied).
3. Place the other end of the hose in a container of a suitable size.
4. From the **Maintenance** menu select **Empty recirculation tank**.
5. Press **F1** to start the pump.
6. The pump stops automatically. To stop it manually, press Stop
7. Follow the on-screen instructions.

**CAUTION**

Avoid skin contact with the cooling fluid additive.

## 7.5 Annually

### Inspecting the dosing arm

1. Lift the dosing arm and move it to the edge of the machine.
2. Inspect the nozzles.
3. If needed, clean the nozzles.

### Inspect the safety cover



**Hint**

If the machine is used for more than one 7-hour shift per day, carry out inspection more often.

1. Visually inspect the safety cover for signs of wear or damage such as cracks, dents, or damage to the sealing edge.

### Replacing the safety cover screen



**Note**

The safety cover screen must be replaced immediately if it has been weakened by collision with projectile objects or if there are visible signs of deterioration or damage.



**Note**

The screen must be replaced to remain compliant with the safety requirements stated in EN 16089.

To ensure its intended safety, the safety cover screen must be replaced every 5 years. A label on the screen indicates when it must be replaced.



### Recirculation unit

See the manual supplied with the specific equipment.

#### 7.5.1 Test the safety devices

The safety devices must be tested at least once a year.



**WARNING**

Do not use the machine with defective safety devices. Contact Struers Service.



**Note**

Testing should always be performed by a qualified technician (electromechanical, electronic, mechanical, pneumatic, etc.).

See

- [Emergency stop ▶ 47](#)
- [Safety cover ▶ 47](#)

## 7.5.2 Emergency stop

### Test 1



1. Press the **Start** button. The machine starts operating.



2. Press the emergency stop.



3. If operation does not stop, press the **Stop** button.
4. Contact Struers Service.

### Test 2



1. Press the emergency stop.



2. Press the **Start** button.



3. If the machine starts, press the **Stop** button.
4. Contact Struers Service.

## 7.5.3 Safety cover

The cover has a safety switch system to prevent the operator from coming into contact with the moving parts of the working zone while the cover is open.

A locking mechanism prevents the operator from opening the cover until the grinding disc stops rotating.

The cover also acts as a shield to guard the operator in case of hazardous projectiles such as specimens which are not properly secured.

### Test 3

1. Open the protective cover.
2. Press the **Start** button.



3. If the machine starts, press the **Stop** button.



4. Contact Struers Service.

## 7.6 Change the tubes

When you use alcohol-based lubricants, the Novoprene tubes mounted in the pumps will harden over time. Silicone has a better resistance against alcohol.

You can replace the tubes with the set of silicone tubes supplied with the unit.



**Procedure**

1. Carefully separate the tubes at the couplings.
2. Press the two tabs on the pump and remove the pump from the axle.
3. Press the two tabs on the pump and remove the bottom cover of the pump.

**Hint**

If needed, use a flat-headed screwdriver to press gently on the tabs.

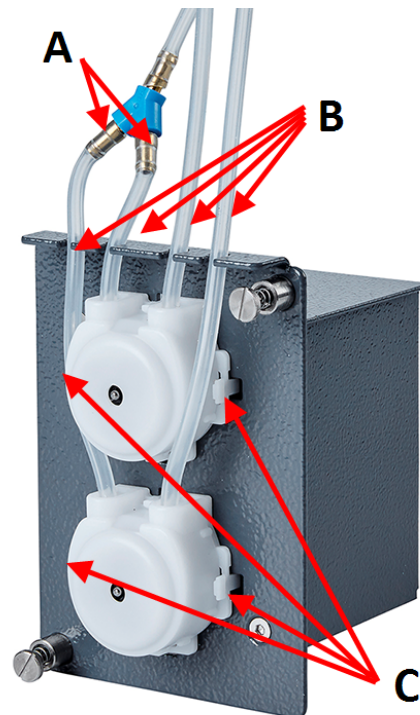

- A Couplings
- B Silicon tubes
- C Tabs

4. Remove the three rollers.



5. Remove the Novoprene tube.
6. Fit the new tube into the housing and press it firmly into place.



7. Press the three rollers into the pump housing.
8. Re-mount the bottom cover.
9. Press the pump back onto the axle.



10. Reconnect the tubes.
11. Make sure that the tubes are connected correctly so that the flow of the fluid is correct.

### 7.7 Calibrating the pumps

The pumps must be calibrated annually or when internal or external hoses or the pump have been replaced.

1. Select **Maintenance > Calibration and adjustments > Calibration of pump capacity**.
2. Press **F4**.
3. Follow the on-screen instructions.



If the calibration value differs more than  $\pm 30\%$  of the nominal value of 100 ml/min. for the DP pump and 100 ml/min. for the OP pump, replace the pump module.

### 7.8 Spare parts

#### Technical questions and spare parts

If you have technical questions or when you order spare parts, state the serial number. The serial number is stated on the type plate of the unit.

For further information, or to check the availability of spare parts, contact Struers Service. Contact information is available on [Struers.com](https://www.struers.com).

**Note**

Replacement of safety critical components must only be performed by a Struers engineer or a qualified technician (electromechanical, electronic, mechanical, pneumatic, etc.).

**Note**

Safety critical components must only be replaced by components with at least the same safety level.

## 7.9 Service and repair

We recommend that a regular service check be carried out yearly or after every 1500 hours of use.

When the machine is started up, the display shows information about total operation time and the machines service information.

After 1500 hours of operation time, the display will show a message reminding the user that a service check should be scheduled.



### Note

Service must only be performed by a qualified technician (electromechanical, electronic, mechanical, pneumatic, etc.).  
Contact Struers Service.

## 7.10 Disposal



Equipment marked with a WEEE symbol contains electrical and electronic components and must not be disposed of as general waste.

Contact your local authorities for information on the correct method of disposal in accordance with national legislation.

For disposal of consumables and recirculation fluid, follow local regulations.

# 8 Troubleshooting - AbraPol-30

Error	Cause	Action
Display text is not clear.	The display is sensitive to temperature changes.	Change the brightness in the <b>Configuration</b> menu.
Water is not draining away.	Drain hose squeezed.	Straighten the hose.
	Drain hose clogged.	Clean the hose.
	Drain hose does not slope downwards.	Adjust the hose to an even slope.
Continuous, irregular wear on a grinding/polishing surface.	Coupling on the specimen holder/mover plate or the specimen mover head is worn.	Replace the coupling. Contact Struers Service.
Water leakage.	A leak in the cooling unit water hose.	Check the hose for leakages and tighten the hose clamp.

Error	Cause	Action
Specimens, cooling unit or equipment is corroded.	Not enough additive for cooling fluid.	Add Struers cooling fluid additive to the cooling fluid. Use the correct concentration. Use a refractometer to check. See the Maintenance section.

## 8.1 Messages and errors - AbraPol-30

Error messages are divided into two classes:

- Messages and errors

### 8.1.1 Messages

Messages provide information about the machine's status and minor errors.

### 8.1.2 Errors

Errors must be corrected before operation can be continued.

Press **Enter** to acknowledge the error/message.

#	Error message	Cause	Action
7	<b>Information</b> <b>Action not allowed by operation mode.</b>	Operation mode does not allow editing.	Change operation mode to a higher level, eg. <b>Configuration</b> .
47	<b>Information</b> <b>The method step is active in the process. Some parameters cannot be edited.</b>	The selected method step is active. You cannot edit some parameters.	Stop the process or wait until the current step is finished.
54	<b>Information</b> <b>The process is paused. This might affect removal accuracy. For the greatest accuracy start a new process.</b>	When the process is paused a new reference point will be calculated for the remaining removal, and this will affect the overall accuracy of the desired removal.	Press OK to continue. Press Stop to cancel the process.
133	<b>Information</b> <b>Lubricant restricted by selected surface and suspension.</b>	The selected lubricant cannot be used with the selected surface and suspension.	Select another lubricant.  For user defined consumables, make sure that the correct consumable rule is assigned.

#	Error message	Cause	Action
134	<b>Information</b> <b>Suspension restricted by selected surface.</b>	The selected suspension cannot be used with the selected surface.	Select another suspension.  For user defined consumables, make sure that the correct consumable rule is assigned.
20	<b>Question</b> <b>Are you sure you want to delete all preparation groups and methods?</b>		<div style="border: 1px solid blue; padding: 5px; margin-bottom: 10px;">  <p><b>Hint</b> You cannot undo deletion of groups and methods.</p> </div> <p>Press <b>Enter</b> to delete all the groups and methods.  Struers methods are not deleted.</p>
101	<b>Warning</b> <b>Cannot keep preset force.</b>	The machine could not maintain the selected force.	Make sure that the air pressure is 6 bar. Re-start the process.  If the error remains, contact Struers Service.
114	<b>Warning</b> <b>Disc motor:</b> <b>Warning: General.</b> <b>Warning code: 0</b>	Non-specific warning reported by movement unit.	Re-start.  If the error remains, contact Struers Service. Make a note of the reason code displayed.
124	<b>Warning</b> <b>Water for polishing valve, bad electrical connection detected.</b>	Bad wiring in the valve controlling polishing water.	Re-start.  If the error remains, contact Struers Service.
125	<b>Warning</b> <b>OP suspension flushing valve, bad electrical connection detected.</b>	Bad wiring in the valve controlling OP flushing.	Re-start.  If the error remains, contact Struers Service.

#	Error message	Cause	Action
126	<b>Warning</b> <b>Disc cooling valve, bad electrical connection detected.</b>	Bad wiring in the valve controlling disc cooling.	Re-start. If the error remains, contact Struers Service.
141	<b>Warning</b> <b>No air connected or air pressure too low.</b>	The air supply is not connected or the pressure is too low.	Check the air supply connection. Make sure that the air pressure is min. 6 bar.
151	<b>Warning</b> <b>Beacon not detected!</b> <b>Either check beacon connection or disable it in Options menu.</b>		If no beacon is installed, disable the beacon in the <b>Options</b> menu. If a beacon is installed: check the connection. Re-start. If the error remains, contact Struers Service..
152	<b>Warning</b> <b>Drain shift valve not detected!</b> <b>Either check shift valve connection or disable it in Options menu.</b>		If no shift valve is installed, disable the shift valve in the <b>Options</b> menu. If a shift valve is installed: Re-start. If the error remains, contact Struers Service.
156	<b>Warning</b> <b>Antidripping valve not detected!</b> <b>Check electrical connection.</b>	The process can continue but water dripping might occur from the dosing arm.	Re-start. If the error remains, contact Struers Service.
46	<b>Error</b> <b>The head did not move down sufficiently for the calibration to start.</b> <b>Calibration aborted.</b>	This message is shown during calibration. The specimen mover head tries to move down to generate force. If it cannot move down enough this error is shown.	Make sure that nothing obstructs the movement of the specimen mover head.

#	Error message	Cause	Action
50	<b>Error</b> <b>Disc motor:</b> <b>The motor is too hot and has been stopped. Allow motor to cool before starting a process.</b>	The load of the motor has made the motor too hot to continue with the process.	Let the motor cool off for 10 minutes. Re-start.
73	<b>Error</b> <b>Disc motor:</b> <b>SMU is offline.</b> <b>Call a Service Technician.</b>	Communication with the stepper motor unit is lost.	Re-start. If the error remains, contact Struers Service.
80	<b>Error</b> <b>The mover head did not move correctly.</b> <b>- Check the air supply.</b> <b>- Check for any obstructions.</b>	Something has prevented the specimen mover head from moving.	Check the air supply. Make sure that nothing obstructs the movement of the specimen mover head.
99	<b>Error</b> <b>Disc motor:</b> <b>Movement is blocked.</b>	Motor and/or movement is blocked.	Make sure that nothing obstructs the movement.
100	<b>Error</b> <b>Disc motor:</b> <b>Error: General.</b> <b>Error code: 0</b> <b>Try to restart the machine</b>	Non-specific error reported by movement unit.	Re-start. If the error remains, contact Struers Service. Make a note of the error code displayed.
103	<b>Error</b> <b>The required air pressure is not obtained.</b> <b>- Check the air supply.</b>		Make sure that the air pressure is min. 6 bar. Re-start. If the error remains, contact Struers Service.

#	Error message	Cause	Action
118	<b>Error</b> <b>Uploading of new consumables failed! Try uploading the consumables again. Consumables has been reset to default.</b>	An error occurred during upload of the consumables table from the PC to the machine.	Check the connection between the PC and machine.
161	<b>Error</b> <b>Disc motor:</b> <b>Frequency inverter temperature alarm.</b> <b>Reason code: 0x0</b>	The load on the frequency inverter which drives the disc motor has caused a temperature alarm.	Reduce the load.
29	<b>Fatal error</b> <b>Emergency stop mode active, but monitoring switch released.</b>	The emergency stop button has been activated, but the internal monitoring switch is not active.	This error can appear if the emergency stop button is released very slowly (i.e. more than several seconds).  Re-start.  If the error remains, contact Struers Service.
44	<b>Fatal error</b> <b>Disc motor:</b> <b>Communication error.</b> <b>Call a Service Technician.</b>	Communication with the disc motor frequency inverter has been lost.	Re-start.  If the error remains, contact Struers Service.
61	<b>Fatal error</b> <b>Machine failed during Power On Self Testing.</b> <b>Try restarting the machine.</b> <b>Contact Struers technical support if the problem persists.</b> <b>Reason: #__ - Unknown error</b>		Re-start.  If the error remains, contact Struers Service.  Make a note of the reason code.



#	Error message	Cause	Action
62	<b>Fatal error</b> <b>The cover open signal is present while the lock is locked.</b> <b>Call a Service Technician.</b>		Make sure that the cover is completely closed. Re-start. If the error remains, contact Struers Service.
77	<b>Fatal error</b> <b>Emergency stop released, but monitoring switch still on.</b> <b>Call a Service Technician.</b>		Re-start. If the error remains, contact Struers Service.

## 9 Technical data

### 9.1 Technical data

	Catalog numbers	06306129, 06306146, 06306229, 06306246
<b>Disc</b>	Diameter	300 mm (12") or 350 mm (14")
	Speed	40 - 600 rpm, adjustable in steps of 10 rpm
	Rotational direction	Counter-clockwise
	Motor power	–
	- Continuous (S1)Continuous (S1)	2.2 kW (2.9 Hp)
	- Maximum (S3)Maximum (S3)	N/A

<b>Specimen mover head</b>	Individual specimen	NA	
	- Force	–	
	- Specimen height	–	
	Specimen holder	–	
	- Diameter	Max. 200 mm	
	- Force	50 - 700 N (10 - 150 lbf)	
	Rotational speed	50 - 300 rpm, adjustable in steps of 10 rpm	
	Rotational direction	Clockwise, Counter-clockwise	
	Motor power	0.55 kW (0.75 Hp)	
	Torque	19 Nm	
	Positioning	35 - 100 mm	
	<b>Features</b>	Material removal sensor (built-in)	–
	<b>Options</b>	Automatic dosing, up to 6 pumps	06306901 DP-Module, 06306902 OP-Module
Shift valve		(06306903 - retrofit version)	
Recirculation cooling system		06296929, 06296946, 06296954	
Beacon		06296900	
<b>Software and electronics</b>	Controls	Touch pad, Turn/push knob	
	Display	LCD, TFT-color 5.7", 320 x 240 dots with LED back light	
<b>Safety standards</b>		See the Declaration of Conformity	
<b>Operating environment</b>	Surrounding temperature	5-40°C (41-104°F)	
	Humidity	< 85 % RH non-condensing	

<b>Power supply</b>	Voltage/frequency	3 x 200 - 240 (50-60Hz), 3 x 380 - 480 (50-60Hz)
	Power inlet	3 phase (3L + PE)
	Power, nominal load	3 kW
	Power, idle	N/A
	Current, nominal load	8.7 A, 4.8 A
	Current, max.	20 A , 11,1 A
<b>Water supply</b>	Pressure, tap water	1 - 4 bar (14.5-58 psi)
	Minimum water flow	10 l/min
<b>Air supply</b>	Pressure, compressed air	6 - 9.9 bar (87-145 psi)
	Air flow/consumption	30 l/min (8 gpm)
	Air quality	The air supplied must be of Class 6.8.4. or better, as specified in ISO 8573-1
<b>Exhaust</b>	Recommended capacity	50 m <sup>3</sup> /h (1750 ft <sup>3</sup> /h)
<b>Safety Circuit Categories/Performance Level</b>	Emergency stop	PL c, Category 1 Stop category 0
	Work zone interlock	PL b, Category b Stop category 0
	Work zone interlock locking	PL a
<b>Residual Current Circuit Breaker (RCCB)</b>		Type B, 30 mA (or better) is required
<b>Noise level</b>	A-weighted sound emission pressure level at workstations	LpA = 61.2 dB(A) (measured value). Uncertainty K = 4 dB
<b>Vibration level</b>	Declared vibration emission	Total vibration exposure to upper parts of the body does not exceed 2.5 m/s <sup>2</sup> .
<b>Dimensions and weight (without cover)</b>	Width	N/A
	Depth	N/A
	Height	N/A
	Weight	N/A

<b>Dimensions and weight (with cover/safety cover)</b>	Width	847 mm
	Depth	996 mm
	Height - cover closed/cover open	1565 (1875) mm
	Weight	390 kg

## 9.2 Safety Circuit Categories/Performance Level

Safety Circuit Categories/Performance Level	
Work zone interlock	EN 60204-1, Stop category 0 EN ISO 13849-1, Category b Performance Level (PL) <b>b</b>
Work zone interlock locking	EN ISO 13849-1, PL <b>a</b>
Emergency stop	EN 60204-1, Stop category <b>0</b> EN ISO 13849-1, Category <b>1</b> Performance Level (PL) <b>c</b>

## 9.3 Noise and vibration levels

<b>Noise level</b>	A-weighted sound emission pressure level at workstations	$L_{pA} = 61.2 \text{ dB(A)}$ (measured value) Uncertainty $K = 4 \text{ dB}$ Measurements made in accordance with EN ISO 11202
--------------------	--	---

<b>Vibration level</b>	During preparation	Total vibration exposure to upper parts of the body does not exceed $2.5 \text{ m/s}^2$ .
------------------------	--------------------	---

## 9.4 Safety Related Parts of the Control System (SRP/CS)



**WARNING**

Safety critical components must be replaced after a maximum lifetime of 20 years. Contact Struers Service.



**Note**

SRP/CS (safety-related parts of a control system) are parts that have an influence on safe operation of the machine.



**Note**

Replacement of safety critical components must only be performed by a Struers Safety critical components must only be replaced by components with at least the Contact Struers Service.

Safety related part	Manufacturer/Manufacturer description	Manufacturer catalog no.	Electrical ref.	Struers catalog no.
Emergency stop button	Schlegel Latching mushroom head	ES Ø22 type RV	S1	2SA10400
Emergency stop contact	Schlegel Contact block	MTO, 1 NC	S1	2SB10071
Emergency stop, Module holder	Schlegel Module holder, 3 elements	MHL	S1	2SA41603
Main safety cover interlock with locking device	Schmersal Solenoid interlock	AZM 170SK-11/02ZRK-2197 24 V AC/V DC	YS1	2SS00025
Safety relay	Omron Safety relay unit	G9SB-3012-A	KS1	2KS10006
Contactors, cooling water	Omron Motor contactor	J7KNG-10-10-24D	K1	2KM71410
Frequency inverter, Disc motor	Lenze Frequency inverter i550	200 V: i55AE222D1AV10001 S 400 V: i55AE222F1AV10001 S	A5	2PU52220 2PU54220
Frequency inverter, Specimen mover	Lenze Frequency inverter i550	200 V: i55AE175D1AV10001 S 400 V: i55AE175F1AV10001 S	A4	2PU52075 2PU54075

## 9.5 Diagrams

If you wish to view specific information in detail, see the online version of this manual.

**9.5.1 Diagrams - AbraPol-30**

Title	No.
AbraPol-30, Block diagram	<a href="#">16303050 D</a>
AbraPol-30, Water diagram	<a href="#">16302005 D</a>
AbraPol-30, Air diagram	<a href="#">16302002 B</a>

16303050 D

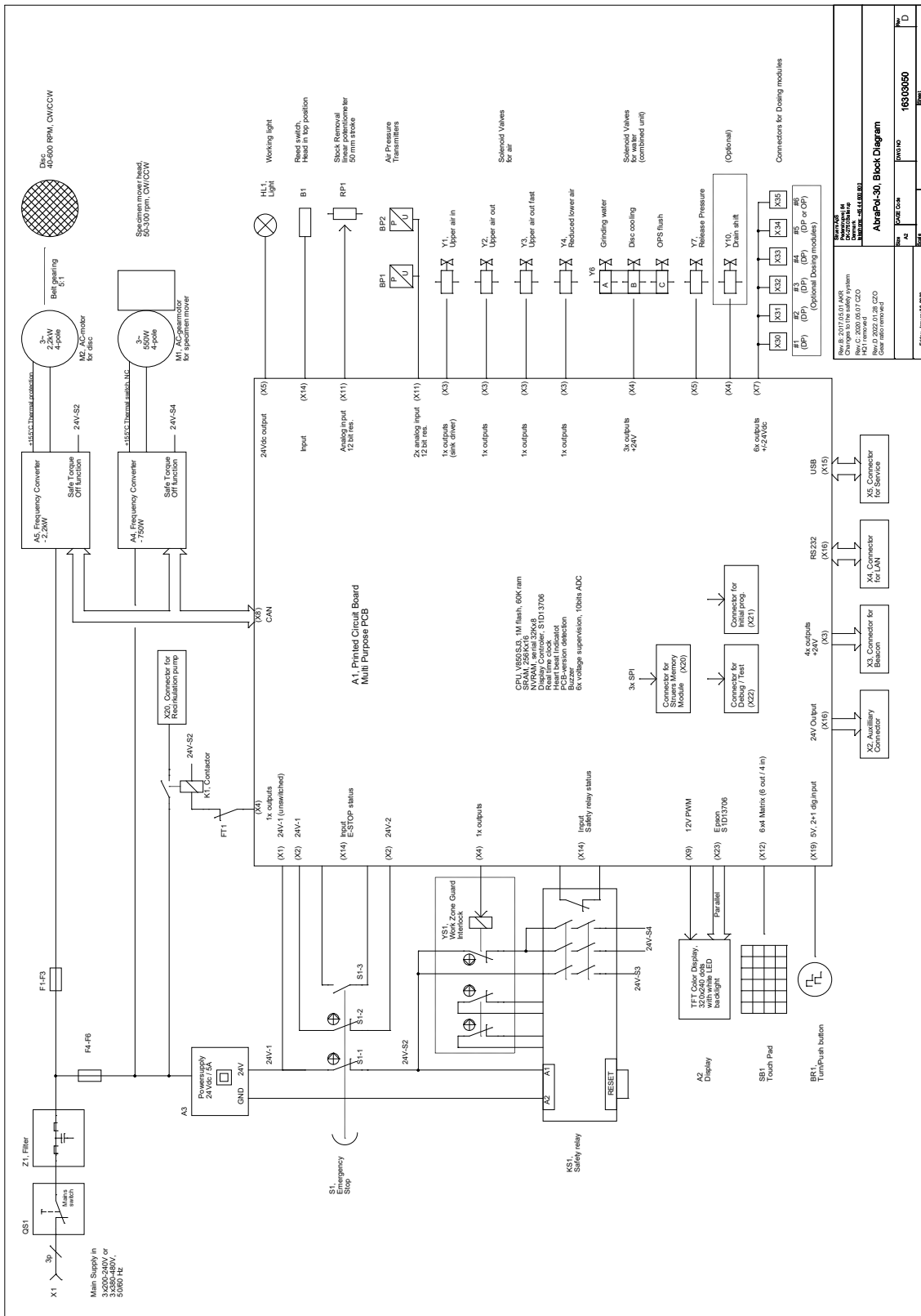

**16302005 D**

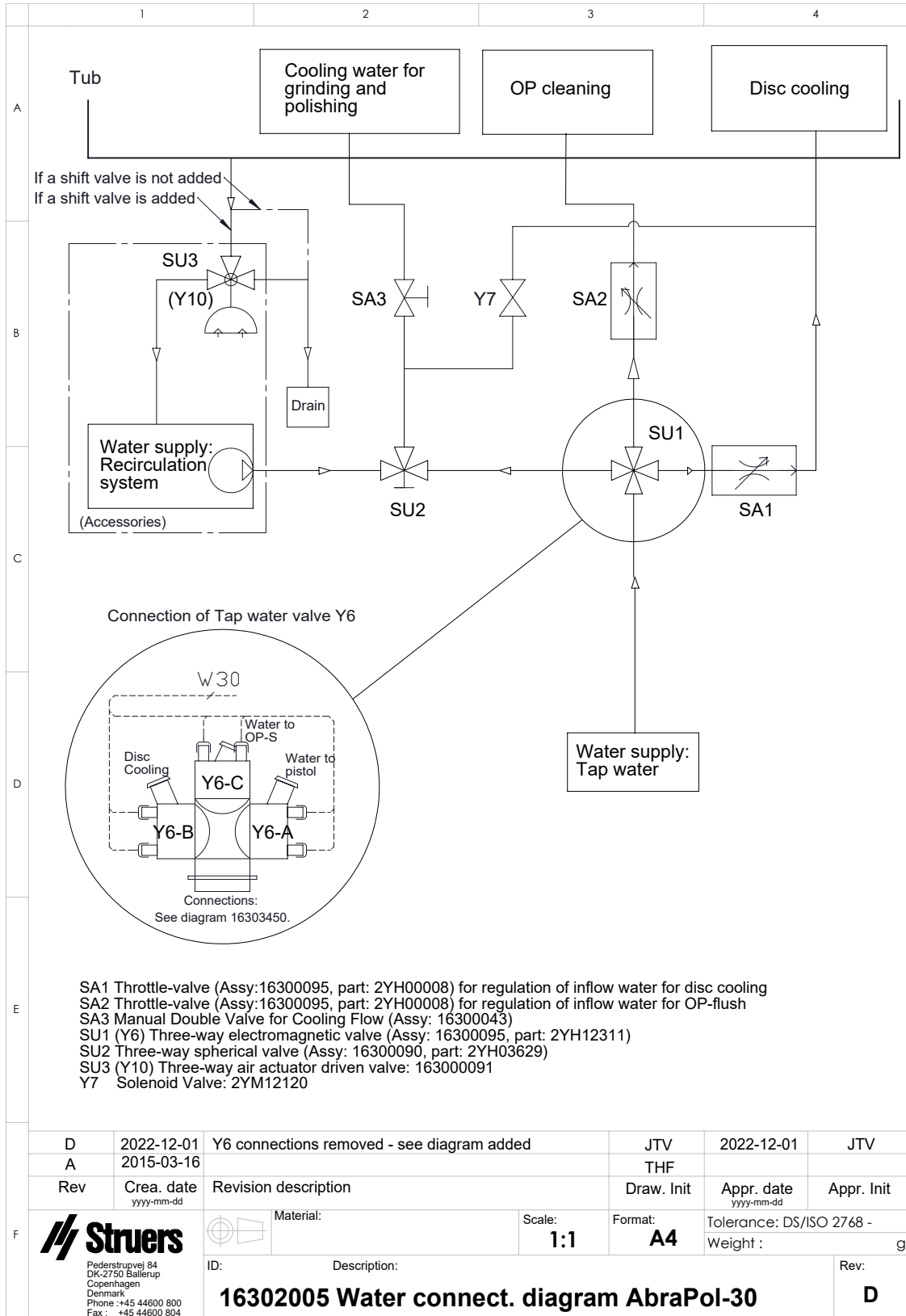



16302002 B

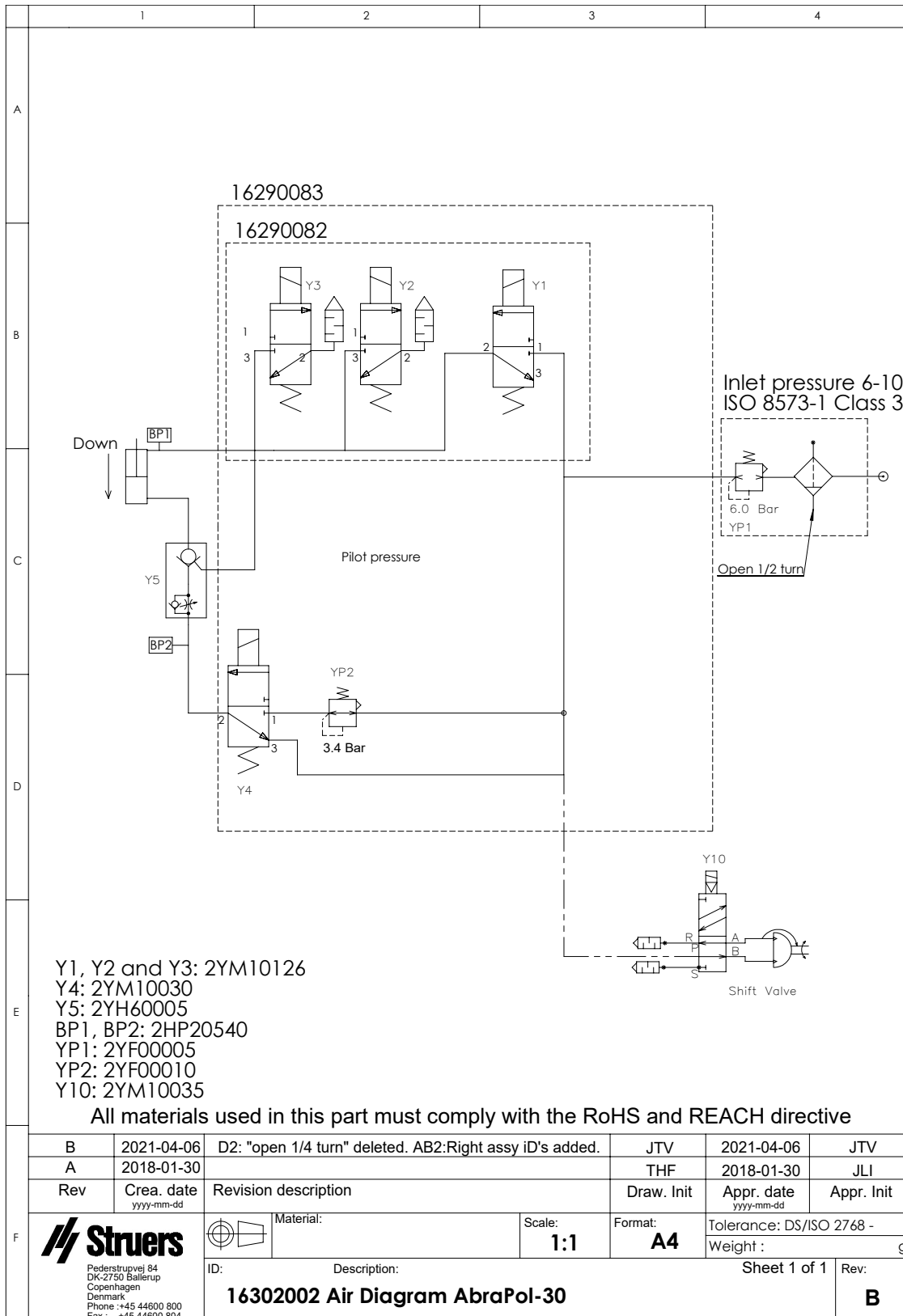

B	2021-04-06	D2: "open 1/4 turn" deleted. AB2:Right assy iD's added.	JTV	2021-04-06	JTV
A	2018-01-30		THF	2018-01-30	JLI
Rev	Crea. date yyyy-mm-dd	Revision description	Draw. Init	Appr. date yyyy-mm-dd	Appr. Init
F	 Pederstrupvej 84 DK-2750 Ballerup Copenhagen Denmark Phone: +45 44600 800 Fax: +45 44600 804	Material:	Scale: <b>1:1</b>	Format: <b>A4</b>	Tolerance: DS/ISO 2768 - Weight: g
		ID:	Description: <b>16302002 Air Diagram AbraPol-30</b>	Sheet 1 of 1	Rev: <b>B</b>

## 9.6 Legal and regulatory information

### FCC notice

This equipment has been tested and found to comply with the limits for a Class B digital device, pursuant to part 15 of the FCC Rules. These limits are designed to provide reasonable protection against harmful interference in a residential installation. This equipment generates, uses and can radiate radio frequency energy and, if not installed and used in accordance with the instructions, may cause harmful interference to radio communications. However, there is no guarantee that interference will not occur in a particular installation. If this equipment does cause harmful interference to radio or television reception, which can be determined by turning the equipment off and on, the user is encouraged to try to correct the interference by one or more of the following measures:

- Reorient or relocate the receiving antenna.
- Increase the separation between the equipment and receiver.
- Connect the equipment into an outlet on a circuit different from that to which the receiver is connected.

# 10 Manufacturer

Struers ApS  
Pederstrupvej 84  
DK-2750 Ballerup, Denmark  
Telephone: +45 44 600 800  
Fax: +45 44 600 801  
[www.struers.com](http://www.struers.com)

### Responsibility of the manufacturer

The following restrictions should be observed, as violation of the restrictions may cause cancellation of Struers legal obligations.

The manufacturer assumes no responsibility for errors in the text and/or illustrations in this manual. The information in this manual is subject to change without notice. The manual may mention accessories or parts not included in the supplied version of the equipment.

The manufacturer is to be considered responsible for effects on safety, reliability, and performance of the equipment only if the equipment is used, serviced, and maintained in accordance with the instructions for use.

# Declaration of Conformity

Manufacturer	Struers ApS • Pederstrupvej 84 • DK-2750 Ballerup • Denmark
Name	AbraPol-30
Model	N/A
Function	Plane grinding and polishing machine
Type	0630
Cat. no.	06306129 06306146 06306229 06306246
Serial no.	



Module H, according to global approach



We declare that the product mentioned is in conformity with the following legislation, directives and standards:

<b>2006/42/EC</b>	EN ISO 12100:2010, EN ISO 13849-1:2015, EN ISO 13849-2:2012, EN ISO 13850:2015, EN 60204-1:2018, EN 60204-1-2018/Corr.:2020
<b>2011/65/EU</b>	EN 63000:2018
<b>2014/30/EU</b>	EN 61000-6-2:2005, EN 61000-6-2:2005/Corr.:2005, EN 61000-6-4:2007, EN 61000-6-4-A1:2011
<b>Additional standards</b>	NFPA 79, FCC 47 CFR Part 15 Subpart B

Authorized to compile technical file/  
Authorized signatory

Date: [Release date]

en For translations see  
bg За преводи вижте  
cs Překlady viz  
da Se oversættelser på  
de Übersetzungen finden Sie unter  
el Για μεταφράσεις, ανατρέξτε στη διεύθυνση  
es Para ver las traducciones consulte  
et Tõlked leiate aadressilt  
fi Katso käännökset osoitteesta  
fr Pour les traductions, voir  
hr Za prijevode idite na  
hu A fordítások itt érhetőek el  
it Per le traduzioni consultare  
ja 翻訳については、  
lt Vertimai patalpinti  
lv Tulkojumus skatīt  
nl Voor vertalingen zie  
no For oversettelser se  
pl Aby znaleźć tłumaczenia, sprawdź  
pt Consulte as traduções disponíveis em  
ro Pentru traduceri, consultați  
se För översättningar besök  
sk Preklady sú dostupné na stránke  
sl Za prevode si oglejte  
tr Çeviriler için bkz  
zh 翻译见

[www.struers.com/Library](http://www.struers.com/Library)