

Magnutom-5000

Instruction Manual



Table of Contents	Page
Intended use	3
Safety Precaution Sheet	5
Icons and typography.....	7
User's Guide	9
Reference Guide.....	66
Quick Reference	122
Pre Installation check list	123
Declaration of Conformity	134

Intended use

Magnutom-5000 is intended for automatic cutting of metallic or other solid materials by wet abrasive cutting.

The machine is only to be operated by skilled/trained personnel in a professional working environment (e.g. a materialography laboratory).

The machine is only intended to be used with cut-off wheels and other consumables specially designed for this purpose and this type of machine*. A cooling and cutting liquid recirculation unit is required for the machine to function as intended.

Do not use the machine for:

Cutting of materials other than solid materials suitable for materialographic studies. In particular, the machine must not be used for cutting any type of explosive and/or flammable material, or materials which are not stable during machining, heating or pressure.

*) See brochure and Struers consumables catalogue for more details about suitable consumables. Contact Struers in case of doubts.

Models:

Magnutom-5000 XYZ w. automatic x-table

Magnutom-5000 XYZR w. automatic x-table, Rotation

Magnutom-5000 YZ with fixed table

**NOTE:**

READ the instruction manual carefully before use.

Keep a copy of the manual in an easy-to-access place for future reference.

Always state *Serial No* and *Voltage/frequency* if you have technical questions or when ordering spare parts. You will find the *Serial No.* and *Voltage* on the type plate of the machine itself. We may also need the *Date* and *Article No* of the manual. This information is found on the front cover.

The following restrictions should be observed, as violation of the restrictions may cause cancellation of Struers legal obligations:

Instruction Manuals: Struers Instruction Manual may only be used in connection with Struers equipment covered by the Instruction Manual.

Struers assumes no responsibility for errors in the manual text/illustrations. The information in this manual is subject to changes without notice. The manual may mention accessories or parts not included in the present version of the equipment.

Original instructions: The contents of this manual is the property of Struers. Reproduction of any part of this manual without the written permission of Struers is not allowed.

All rights reserved. © Struers 2023.

Struers

Pederstrupvej 84
DK-2750 Ballerup
Denmark
Telephone +45 44 600 800
Fax +45 44 600 801



Magnutom Safety Precaution Sheet

Read carefully before use

1. Ignoring this information and mishandling of the equipment can lead to severe bodily injuries and material damage.
2. The machine must be installed in compliance with local safety regulations.
3. The machine must be placed on a stable floor which is able to carry at least 3000 kgs / 6600 lbs (Magnutom, Coolimat and specimens). The machine must be levelled by means of the adjustable legs provided.
4. When lifting the machine by the built-in truck lifting point, ensure that the boom is properly secured with the locking pins provided.
5. Before transport, secure the drive shaft with the locking system provided.
6. The operator(s) must read the Safety and User's Guide sections of this manual and the relevant sections of the manuals for any connected equipment and accessories.
The operator(s) must read the Instructions for Use and, where applicable, Safety Data Sheets for the applied consumables.
7. All safety functions of the machine must be intact and in working order. The machine must be installed in compliance with local safety, regulations.
8. Use only intact cut-off wheels. The cut-off wheels must be approved for a minimum peripheral speed of 42 m/s.
9. The machine is not for use with saw-blade type cut-off wheels.
10. Do not use the machine for cutting materials that are flammable or unstable during the cutting process (e.g. combustible or explosive materials).
Do not use the machine for cutting materials that are not suitable for materialographic cutting.
11. Observe the current safety regulations for handling, mixing, filling, emptying and disposal of the additive for cooling fluid.
12. The workpiece must be securely fixed in the a quick-clamping device or similar. Large or sharp workpieces must be handled in a safe way.
13. Use of safety goggles and gloves are recommended when using the flushing hose.
14. Do not work on or around cutting table when the table is repositioned.
15. For maximum safety and lifetime of the machine, use only original Struers consumables.

- 16.** Laser radiation. Do not stare into beam or expose users of telescopic optics. Class 2M laser product.
- 17.** Struers recommend the use of an exhaust system as the cutting materials may emit harmful gasses or dust
- 18.** Observe the current safety regulations for handling, mixing, filling, emptying and disposal of the additive for cooling fluid.
Do not use flammable cooling fluid.
Use of gloves and goggles are recommended.
Do not use cooling liquid other than water and Struers additives for cooling fluid.
- 19.** In case of fire, alert bystanders, the fire brigade and cut power.
Use a powder fire extinguisher. Do not use water.
- 20.** The machine must be disconnected from the mains prior to any service.
- 21.** Ensure that the cut-off wheel is secured before working on or around the cutting table.
- 22.** Only use the flushing gun for cleaning *inside* the cutting chamber.
- 23.** If any unusual noise is heard during operation, refrain from further use of the machine, and contact a Struers Service Technician.

The equipment should only be used for its intended use and as detailed in the Instruction Manual.

The equipment is designed for use with consumables supplied by Struers. If subjected to misuse, improper installation, alteration, neglect, accident or improper repair, Struers will accept no responsibility for damage(s) to the user or the equipment.

Dismantling of any part of the equipment, during maintenance, service or repair, should always be performed by a qualified technician (electromechanical, electronic, mechanical, pneumatic, etc.).

Icons and typography

Struers uses the following icons and typographical conventions. A list of the Safety Messages used in this manual can be found in the chapter on *Cautionary Statements* in the Reference Guide section of the Instruction Manual.

Always consult the Instruction Manual for information on the potential hazards marked by the icons fixed to the machine.



ELECTRICAL HAZARD

indicates an electrical hazard which, if not avoided, will result in death or serious injury.



DANGER

indicates a hazard with a high level of risk which, if not avoided, will result in death or serious injury.



WARNING

indicates a hazard with a medium level of risk which, if not avoided, could result in death or serious injury.



CAUTION

indicates a hazard with a low level of risk which, if not avoided, could result in minor or moderate injury.



CRUSHING HAZARD

indicates a crushing hazard which, if not avoided, could result in minor, moderate or serious injury.



EMERGENCY STOP

General Messages

**NOTE:**

indicates a risk of damage to property, or the need to proceed with special care.

**HINT:**

indicates additional information and tips.

Colour Inside Logo



The 'colour inside' logo on the cover page of this Instruction Manual indicates that it contains colours which are considered to be useful for the correct understanding of its contents.

Users should therefore print this document using a colour printer.

Typographic conventions

Bold type	indicates button labels or menu options in software programs
<i>Italic type</i>	indicates product names, items in software programs or figure titles
■ Bullets	indicates a necessary work step

User's Guide

Table of Contents	Page
1. Getting Started	
Device Description	12
Checking the Contents of Packing.....	12
Unpacking and Placing Magnutom	13
Getting Acquainted with Magnutom.....	15
Hold-to-run operation	16
Power Supply	17
Compressed Air Connections.....	19
Emptying the Water / Oil Filter.....	19
Mounting a Cut-off Wheel.....	19
Connection to an External Exhaust System.....	21
Noise Level	21
Handling noise (during operation.....	21
Connecting a Recirculation Cooling Unit	22
Connecting a Coolimat-2000 Recirculation Cooling Unit	22
Connecting other Struers Cooling Systems	22
Connecting Other External Filter Units	23
Moveable X-Table (option)	23
Moveable R-Table (option).....	24
2. Operation	
Using the Controls.....	25
Control Panel	25
Sleep Mode	27
Before cutting	27
Using the Joystick	27
Signals	28
Cutting chamber lights.....	28
Signalling light (option)	28
Navigating the Software	30
Setting the Language	30

Main Menu	31
Changing the Language	32
Editing Numeric Values	33
Editing Alphanumeric Values.....	34
Editing Cutting Sequences Names	35
Single Cut	36
Feed speed	37
Cut length.....	37
Cut-off wheel.....	38
Wheel Speed	38
Cutting Mode.....	39
Cutting Sequence.....	40
New Cutting Sequence.....	40
Cut-off wheel.....	42
Start position	42
Move to start position	42
Capture current position	43
RPM compensation	43
Safe move.....	44
Capture current position	45
Cutting Mode.....	46
Feed speed	46
Cut length.....	46
Cut-off wheel.....	47
Wheel Speed	47
Clamping the Workpiece	49
Cutting on Magnutom	50
Starting the Cutting	50
The Cutting Process Screen.....	51
Manual Stop.....	52
Re-starting cutting.....	52
Additional Cooling	53

3. Maintenance	
General Cleaning	54
Daily	54
AxioWash.....	55
Cleaning the Cutting Chamber	56
Maintenance of Cut-off Wheels	57
Storage of Bakelite Bonded Al ₂ O ₃ Cut-off Wheels	57
Maintenance of Diamond and CBN Cut-off Wheels.....	57
Weekly	57
Cleaning the Cutting Chamber	58
Monthly	58
Replacing the Cooling Fluid	58
Lubricating the Movement Mechanisms	58
Maintenance of Cutting Table.....	58
Yearly.....	59
Inspection of Cover	59
Testing Safety Devices.....	60
4. Cautionary Statements	62
5. Disposal.....	65

1. Getting Started

Device Description

Magnutom-5000 is an automatic cut-off machine, designed for cutting of large and over-sized workpieces. The machine is designed for wet, abrasive cutting of all stable and non-explosive metals. It is equipped with a re-circulation system for cooling liquid.

The cutting process starts by securing the workpiece to the cutting table with clamping tools. The operator selects the cutting parameters and consumables (e.g. cut-off wheel).

The operator closes the safety guard, which locks when the operator starts the machine. It remains locked for the duration of the cutting. When the cut-off wheel stops, the lock releases and the workpiece and the specimen can be removed.

In case of a power loss during a cutting process, use the special key to open the power-to-open safety guard. Finally, the category B emergency stop cuts the power to the cut-off wheel - the safety guard can be opened once the cut-off wheel comes to a standstill.

The machine may be connected to an external exhaust system to remove fumes from the cutting process.

Checking the Contents of Packing

The packing box contains the following items:

- 1 Magnutom
- 4 Drain pipes for water outlet
- 3 Elbow pipes for water outlet
- 1 Fork spanner 36 mm
- 1 Key for hardware compartment
- 1 Key for door lock
- 1 Coolimat connection kit
- 1 Instruction Manual Set

Unpacking and Placing Magnutom



WARNING

When lifting the machine by the built-in truck lifting point, ensure that the boom is properly secured with the locking pins provided. Adjust the position of the fork following the pictures below to prevent a damage of the machine.

Move the crate as close as possible to the desired location, using a fork lift.

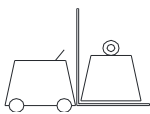

With a fork lift

- Remove the sides of the crate.
- Remove the bolts securing Magnutom to the pallet.
- Using the forklift, lift Magnutom approx. 5 cm



Lift from front (recommended)

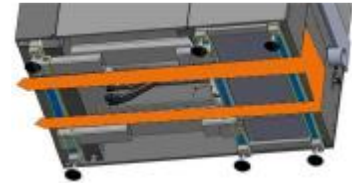

Lift from right-side

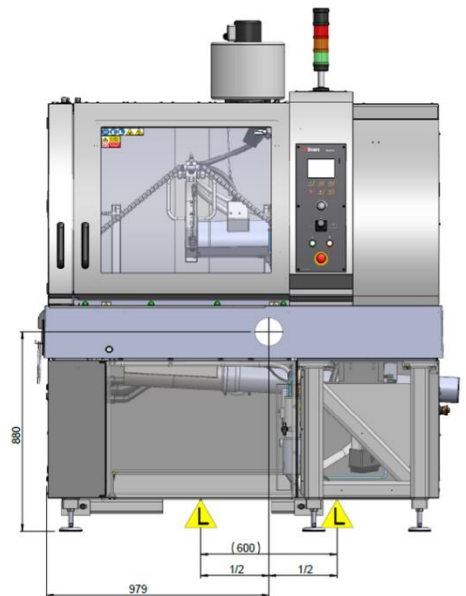
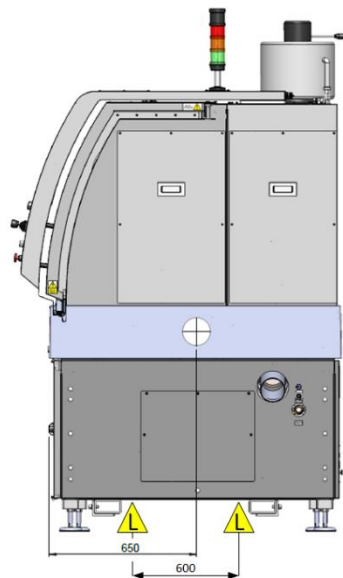

- Remove the pallet and the plastic covering
- Lower Magnutom slowly to the ground.
- Using the special rollers, move the machine to its final position.
- Adjust the 6 legs to level the Magnutom. Place a level device on the cutting table.
- Allow Magnutom to reach room temperature and become acclimatised before connecting to electrical power.
- Remove the transport beams and the spindle support and store for future use.



HINT:

Store the packing crate, foam packaging, fittings, transport- and transport beams for future use.

Failure to use the original transport safety devices and fittings could cause severe damage to the machine and will void the warranty.

Getting Acquainted with Magnutom

Take a moment to familiarise yourself with the location and names of the Magnutom components.

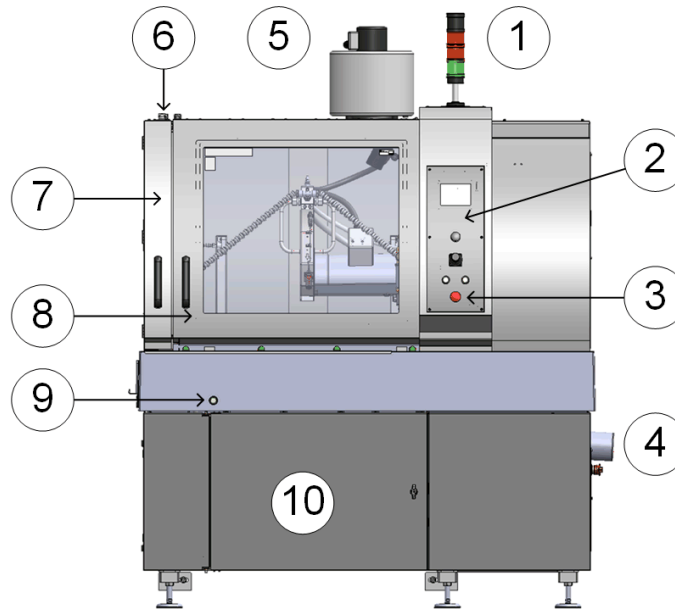

- | | | | |
|---|-----------------------------|----|---------------------|
| 1 | Signalling light (optional) | 6 | Safety lock release |
| 2 | Control Panel | 7 | Side door |
| 3 | Emergency stop | 8 | Front door |
| 4 | Water outlet | 9 | Hold-to-run button |
| 5 | Demister (optional) | 10 | Access door |



MAIN SWITCH

The main switch is located on the left hand side of the machine.

- Turn clockwise to switch on the power.



The EMERGENCY STOP is located on the front of the machine.

Emergency Stop

- Push the red button to Activate.
- Turn the red button clockwise to Release.



NOTE:

Do not use the Emergency stop for operational stop of the machine during normal operation.

BEFORE releasing (disengaging) the Emergency stop, investigate the reason for activating the Emergency stop and take any necessary corrective action.

Hold-to-run operation

To move the cut-off wheel while the protection hood or side door are open, press the Hold-to-run button while operating the joystick.

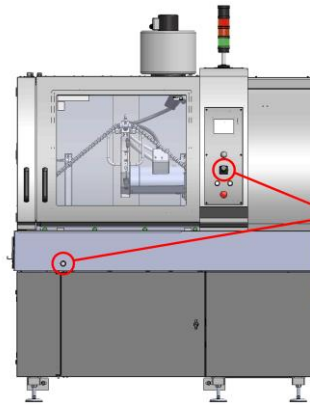

Press Hold-to-run button while operating the joystick.



NOTE:

Hold-to-run functionality might get corrupted in case of a collision between i.e. the cut-off wheel and workpiece. This state is represented by a non-responsive hold-to-run button (Information message #59) meaning that cut-off wheel movement is possible only with closed guards. Please restart the machine or initiate a cutting process in order to reset the hold-to-run functionality.

Inside the Cutting Chamber

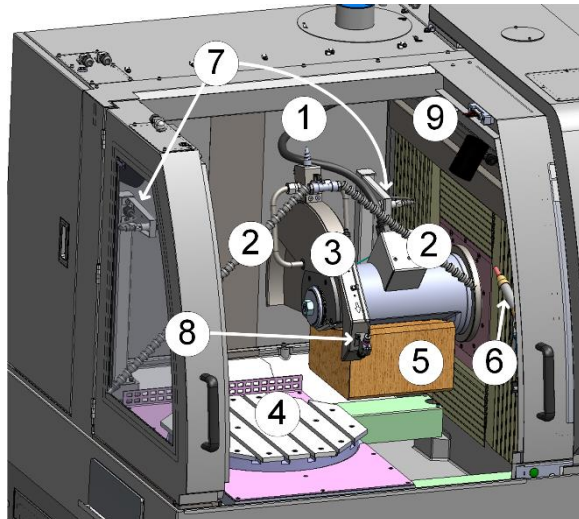

- | | | | |
|---|---------------------|---|-----------------------|
| 1 | AxioWash nozzle | 6 | Flushing gun |
| 2 | Flexible water jets | 7 | Cut-off wheel sensors |
| 3 | Cut-off wheel Guard | 8 | Laser |
| 4 | Cutting table | 9 | Safety latch |
| 5 | Support block* | | |

*Use the support block during transport and during spindle service.

Side views

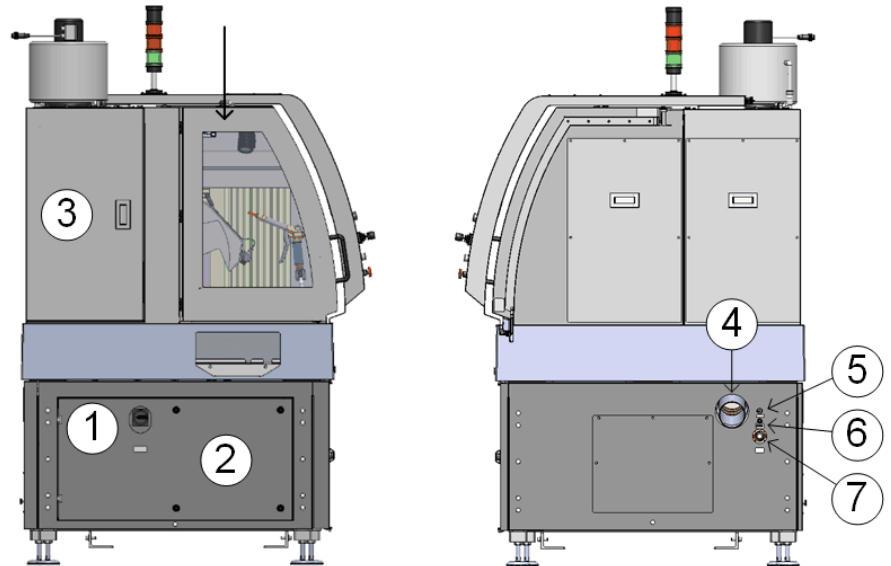

- | | |
|---|---|
| <p>1 Main Switch</p> <p>2 Access to Electrical connection box</p> <p>3 Inspection door</p> | <p>4 Water outlet</p> <p>5 24 V connection for Recirculation Cooling Unit</p> <p>6 Compressed air inlet</p> <p>7 Quick coupling for water inlet</p> |
|---|---|

Power Supply



ELECTRICAL HAZARD

- Switch the power off when installing electrical equipment.
- The machine must be earthed.
- Check that the mains voltage corresponds to the voltage stated on the type plate on the side of the machine.
Incorrect voltage may result in damage to the electrical circuit.

- Open the electric connection box and connect a 4-lead or 5-lead cable¹ in the following way:

Yellow/green: Earth (ground)

Brown or Black, Line (live) L1, L2, L3

Black or Red, Grey or Orange

Blue or White: Neutral (terminal is only used for a mechanical connection)

¹ Please see the section on *Technical Data* at the rear of the Instruction Manual for recommended cable specifications.

- The other end of the cable can be fitted with an approved plug or hard-wired into the mains, according to the electrical specifications and local regulations.



NOTE:

Check that the mains voltage corresponds to the voltage stated on the type plate on the side of the machine.

NOTE:

The doors can only be opened when the machine is connected to a power supply and the main power switch is on.

To open the doors when the power is not connected, use the triangle key to release (de-activate) the safety lock.



HINT:

Magnutom cannot operate if the safety lock is de-activated.

Remember to re-activate the safety lock before operating Magnutom.

Compressed Air Connections

To connect compressed air:

- Connect an 8 mm compressed air hose to the compressed air inlet.



NOTE:

The air pressure must be between 5.5 bar (80 psi) and 9.9 bar (145 psi) min 40l/min.

Emptying the Water / Oil Filter

Magnutom is fitted with a water / oil filter that removes excessive amounts of these substances from the compressed air supply. As a result of this, it is necessary to empty the filter periodically:

- Hold a container under the release outlet valve and press the release valve.

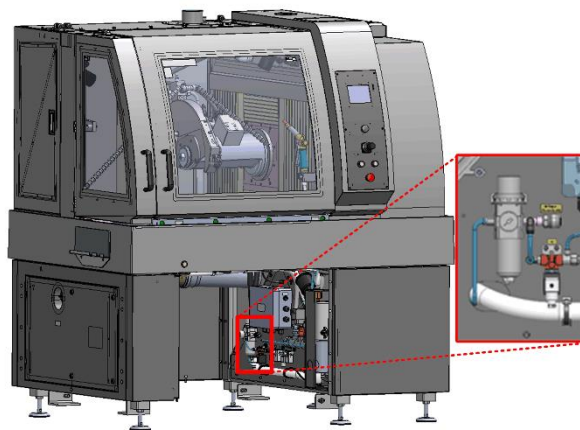

Mounting a Cut-off Wheel



NOTE:

The spindle doesn't lock automatically when a door is opened.

- Activate Spindle lock on Control panel.
- Remove the support block under the cut-off wheel drive shaft².
- Remove the nut with a fork spanner (36mm).
Note that the spindle has reverse / left-hand thread.
- Remove the flange.
- Mount the new cut-off wheel.
- Mount the flanges and nut.
- Tighten the nut with the supplied wrench.
 - The nut should be tightened with a force of minimum 22 – 27 Nm (16 – 20 lbf/ft)
- Release spindle lock (spindle lock is also automatically released when cutting process is started).

² First time – or after transport/spindle service.

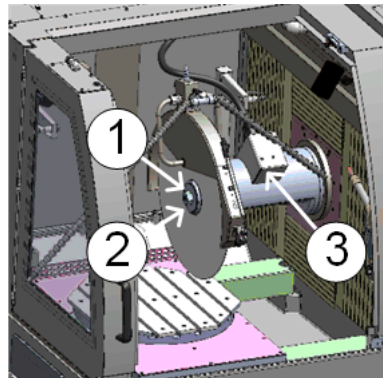

- 1. Nut
- 2. Flange
- 3. Spindle lock



- 4. Spindle lock button



NOTE:

Conventional cut-off wheels based on $\text{Al}_2\text{O}_3/\text{SiC}$ abrasives should be placed between two cardboard washers, to protect the cut-off wheel and flanges.

NOTE:

For maximum precision with diamond or CBN cut-off wheels, do not use cardboard washers.

Connection to an External Exhaust System

Struers recommends the use of an exhaust system as workpieces may emit harmful gases when cut.

Magnutom is prepared for connection to an exhaust system via a 100 mm (approx. 6.3") fitting on the top of the cabinet.

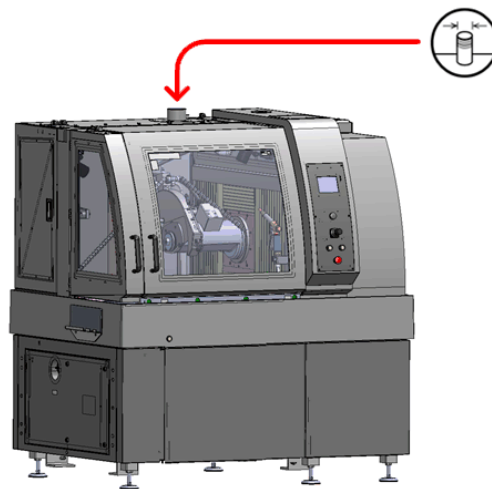

Recommended minimum capacity for exhaust system:
700m³/h / 25,000 ft³/h at 0 mm /0" water gauge.



NOTE:

When a central exhaust system is not available, the optional Demister is recommended.

Noise Level

Find the sound pressure level value under Technical Data.

Handling noise (during operation)

Different materials have different noise characteristics.

Decreasing the rotational speed and/or the force with which the specimen is pressed against the preparation disc, will lower the noise.

Processing time may increase.



CAUTION

Prolonged exposure to loud noises may cause permanent damage to the hearing,

Use hearing protection if exposure to noise exceeds levels set by local regulations.

Connecting a Recirculation Cooling Unit

To ensure optimal cooling, Magnutom should be fitted with a Recirculation Cooling Unit.

Struers Coolimat-2000 is designed for use with large cut-off machines such as Magnutom. Coolimat-2000 are available as a Band Filter or a Static Filter unit.



NOTE:

Before connecting the cooling unit to the Magnutom, follow the instructions in the Cooling Units Instruction Manual to prepare it for use.



CAUTION

During cutting, the cooling fluid coming out of the water outlet may be very hot.

Connecting a Coolimat-2000 Recirculation Cooling Unit

- Lead the long drain pipe through the opening in the wall of the cabinet, and then connect it to the drain outlet under the cutting table.
- Connect to Coolimat-2000 using the pipes and connectors supplied.
- Magnutom, connect the other end to the pump on the cooling unit.
- Connect the 24 V / CAN control cable (supplied with Coolimat-2000) to the 24 V socket on the right hand side of Magnutom, and the other end to the Control unit.

Connecting other Struers Cooling Systems

- Slide the cooling unit into the compartment under the Magnutom.
- Connect the 24 V / CAN control cable (supplied with the Cooling System) to the 24 V socket on the right hand side of Magnutom, and the other end to the Cooli control unit.
- Connect the water inlet tube to the quick coupling on the side of Magnutom, connect the other end to the pump on the cooling unit.
- Close the compartment door.

Connecting Other
External Filter Units



NOTE:

Please contact a qualified electrician to verify that the external filter unit can be used with Magnutom. The electrical diagrams in the Spare Parts section of the manual can be used for identification of the different wires.

The pressure of the cooling fluid supplied to Magnutom must be max 4.9 bar.

- Mount an elbow pipe on the drain outlet under the cutting table.
- Lead the drain pipe through the opening in the wall of the cabinet, and then connect it to the elbow pipe.
- Connect to the external unit using the pipes and connectors supplied.
- Connect the water inlet tube to the quick coupling on the side of Magnutom; connect the other end to the pump on the cooling unit.
- Connect a 24 V electric (available as an accessory, part no 15483549) to the 24 V socket on the right hand side of Magnutom, and the other end to the external unit.
The electric 24 V signal (max 200 mA) can be used to start a pump or open a magnetic valve for the water supply. It might be necessary to use a relay to control connected equipment.

Moveable X-Table (option)

The X-table option is a motor driven, movable table. The table can be moved left to right by moving the joystick left or right.

The X-table option is required to use the Magnutom's Cutting sequence functions.

Position X-table

Before cutting the workpiece, position it by moving the X-table to its start point, using the joystick.

If doors are open, press the hold-to-run button and move the table with the joystick.



CRUSHING HAZARD

Keep hands clear of X-table while positioning it.

Moveable R-Table (option)

The Rotary-table option is a motor driven, movable table. The table can be moved left to right by moving the joystick left or right and can rotate +/-180°, by rotating joystick.

The R-table option is required to use the Magnutom's Cutting sequence functions.

Position Rotary Table

Before cutting the workpiece, position it by rotating the Rotary table to its start point, using the joystick.

If doors are open, press the hold-to-run button and rotate the table with the joystick.



CRUSHING HAZARD

Keep hands clear of R-table while positioning it.

2. Operation

Using the Controls Control Panel









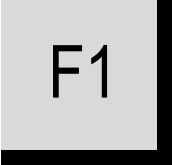
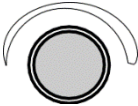

Magnutom-5000, XY table control panel.

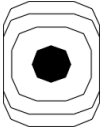

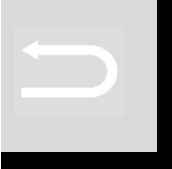
Magnutom-5000, Rotary table control panel.

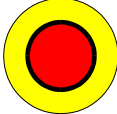
Magnutom 5000
Instruction Manual

Name	Key	Function	Name	Key	Function
FUNCTION KEY		Menu dependent multi-function key. See the bottom line of the individual screens.	TURN/PUSH KNOB 1		Multifunction knob. Push knob to select function. Turn knob to move the cursor or to adjust settings. Push knob to store modified settings
FLUSH		Starts/ Stops water flow to the flushing gun.	JOYSTICK 2		Move up- or downwards to position cut-off wheel. Twist to move forwards/backwards. Twist plus push to rotate (option) Move left- or right to position the x-table (option)
AXIOWASH		Starts AxioWash cycle.	START 3		Starts the machine and recirculation unit and/or band filter.
Escape		Moves one step backward in menus. If modified parameters have not been stored, they are aborted.	STOP 4		Stops the machine and recirculation unit and/or band filter.
Laser		Turns on/off Laser.	EMERGENCY STOP 5		Push the red button to Activate. Turn the red button to Release.
SPINDLE LOCK		Activate/deactivate Spindle lock			

Sleep Mode

If the Magnutom has not been used for 15 minutes, the backlight is dimmed and the cutting chamber light is switched off. This is to increase their lifetimes.

- Push any Control Panel key to reactivate the backlight and the light.

Before cutting

The safety doors must be closed and locked during the cutting process.



WARNING

Check that the safety latch is untampered with and operational before cutting.

Using the Joystick

The joystick can be used to rapidly advance the cut-off wheel towards the workpiece (for example, if the cut-off wheel has been changed whilst cutting a workpiece).

The joystick can also be used to move the cut-off wheel during the cutting process –

Finally, use the joystick to move the X-table and rotate Rotary table if that is present.

AutoCut Off – to **quickly** move the cut-off wheel towards the workpiece and move the cut-off wheel position during cutting.

AutoCut Simple or Program – to move the cut-off wheel position during cutting.



NOTE:

To avoid damage to the cut-off wheel; forward movement is limited to 3 x the pre-set Feed Speed, backwards movement is limited to 5 x the pre-set Feed Speed.

Magnutom is also equipped with an automatic detection system when the cut-off wheel comes into contact with the workpiece.

However, certain combinations of a small workpiece and angle of approach can result in the workpiece not being detected automatically.

NOTE:

Take care when positioning the cut-off wheel.

A collision with the workpiece or clamping tool may damage the cut-off wheel.

Signals

Cutting chamber lights

The Cutting chamber lights will flash continuously if Magnutom has been idle for 30 seconds after a cutting process is completed. (The lights will not flash if the operator has interacted with Magnutom)

Signalling light (option)

Signalling light

The optional signalling light mounted on top of Magnutom signals the current condition of the machine.

Green

Magnutom is busy cutting

Yellow

Attention required
Cutting process is complete and Magnutom is idle

Red

An unexpected stop has occurred and requires immediate attention

Beeps

The "Signalling light sound" is a configurable signal for directing attention to some of the state changes to "Emergency" and "Stopped".

Emergency state:

signaled by a repeated series of a beep and a short pause.

Stopped state:

signaled by a repeated series of a beep and a long pause.

The beeps can be stopped by acknowledging the pop-up message.

Overview of Signals*

State	“Operating”	“Stopped”	“Attention”	“Emergency”
	Green light Operation is in progress.	Yellow light Operation is stopped. A caution or marginal condition is detected, and attention is required.	Yellow light Stopping is impending. A caution or marginal condition is detected, and attention is required.	Red light Operation is stopped. A protective device is engaged, or immediate action is required to deal with a hazardous condition.
Event				
<u>Start</u> or <u>Continue</u> is pressed	State change ⇒ Operating	State change ⇒ Operating		
Process is complete			State change ⇒ Stopped	State change ⇒ Stopped
Manual stop is pressed			State change ⇒ Stopped	State change ⇒ Stopped
A door is opened			State change ⇒ Emergency	State change ⇒ Emergency
Emergency stop is pressed			State change ⇒ Emergency	State change ⇒ Emergency
Thermal overload	Beep ON	State change ⇒ Emergency Beep ON	State change ⇒ Emergency Beep ON	State change ⇒ Emergency Beep ON

* when optional Signalling light is fitted.

Navigating the Software

Use the TURN/PUSH knob to navigate the software:



Push knob to select a menu or item.



Turn knob to move the cursor or to adjust settings.



Press knob to store modified settings.

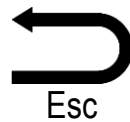

Press Esc  to return to the previous menu, without saving changes.

The *Main menu* is the highest level in the menu structure.
Cutting methods can be selected and edited and/ or started.

Other functions such as defining user cut-off wheels or changing operation mode can be carried out in the [Maintenance](#) and [Configuration](#) menus. Details of these functions can be found in the **Reference Guide** section of the Instruction Manual.

Setting the Language

When the Magnutom is switched on for the first time, a screen on the control panel prompts you to select your preferred language. Then to set the date and time.

- From the pop-up menu, select your preferred language by turning the knob then enter the setting by pushing the knob.
- Press Esc  to move to the Main Menu.

Whenever the Magnutom is switched on the screen displays the version number of the software.

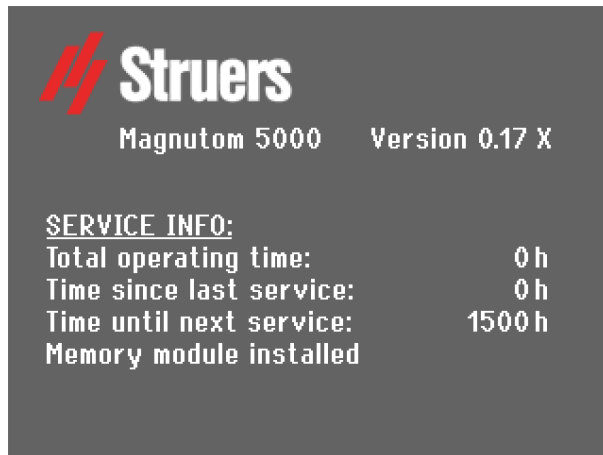

Additionally, some service information is supplied; the total operation time and the time since the last service of the machine.

The display will then change to the last screen shown before Magnutom was switched off.

Main Menu

During normal operation, immediately after start up, where the splash screen is displayed, the software goes to the screen that was used before the machine was switched off. Thus, you can continue exactly where you left last time the machine was used.

The Main Menu is the highest level in the menu structure. From this menu, you can enter all the other menus.

To enter the *Main menu*:

- Press Esc ↵ until the *Main menu* is displayed.

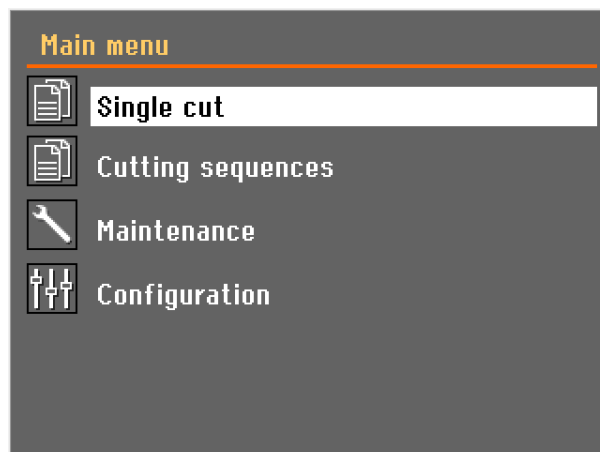

Changing the Language

Follow these steps:

- Turn the knob to select Configuration.
- Push knob to activate the Configuration Menu.
- Turn the knob to select *User options*.

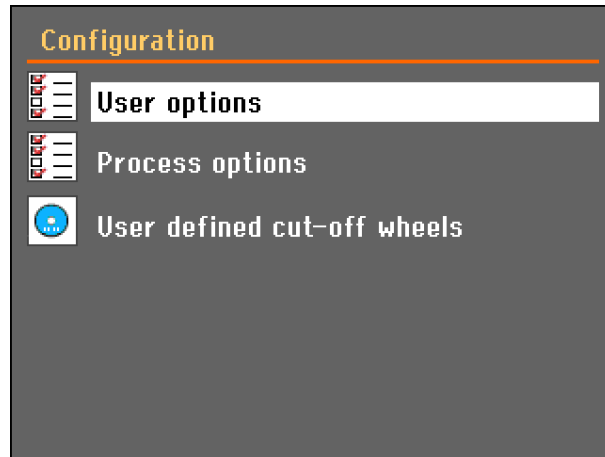

- Push knob to activate the Options Menu.
- Turn knob to select Language.



- Push knob to activate the Select language pop-up menu.
- Turn knob to select the language you prefer.

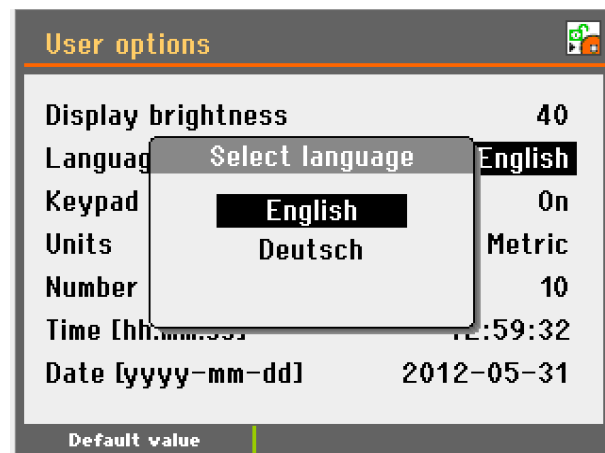

- Push knob to accept the language.
- The Configuration menu now appears in the language you have chosen.
- Check if there are any other settings that need changing in the Options menu. If not, Push Esc \Rightarrow to return to the Configuration menu.
- Otherwise use the Turn/Push knob to select and change the required parameters

Editing Numeric Values

Follow these steps:

- Turn knob to select the value to be changed, e.g. Display brightness:

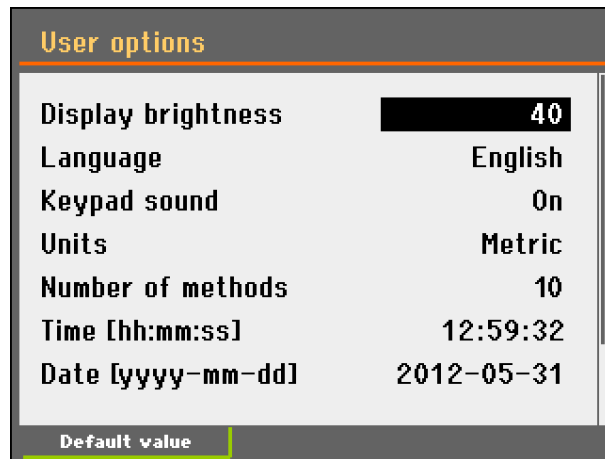

- Push knob to edit the value.
- A scroll box appears around the value.

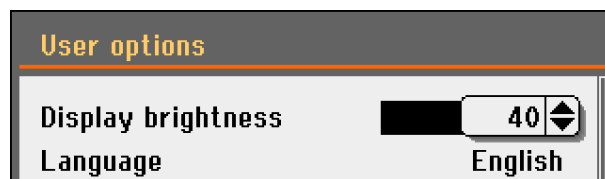

- Turn knob to increase or decrease the numeric value (or to toggle between the two options).
- Push knob to accept the new value. (Pressing Esc \Rightarrow , aborts the changes, preserving the original value.)



NOTE:

If there are only two options, the popup box is not displayed. Pressing the knob (Enter) will toggle between the 2 options.

Editing Alphanumeric Values

Follow these steps:

- Turn knob to select the text value to be changed, e.g. Keyboard sound:

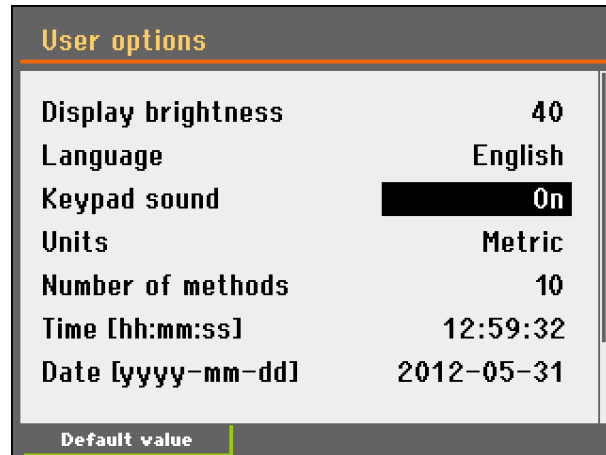

- Push knob to toggle between the 2 options.

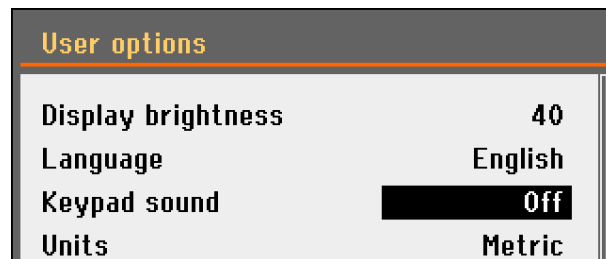

- Press Esc  to accept the option and return to the previous menu
- Or turn knob to select and edit other options in the menu.



NOTE:

If there are more than two options, a popup box is displayed. Turn knob to select the correct option.

Editing Cutting Sequences Names

Up to 20 cutting sequences can be saved in the database. Each cutting sequence can contain up to 50 movements. Follow these steps:

- Push knob to open the *Cutting sequences* menu.

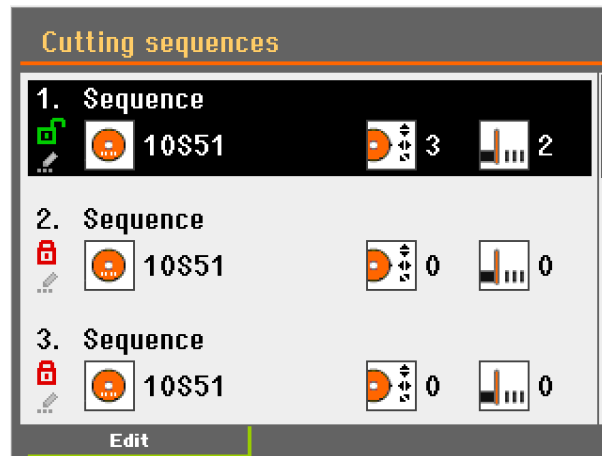

- Turn knob to select a sequence.
- Press F1 to open the *Edit* menu.

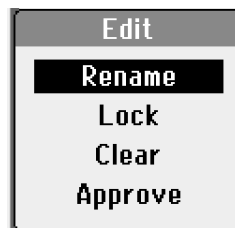

- Push knob to *Rename* sequence.

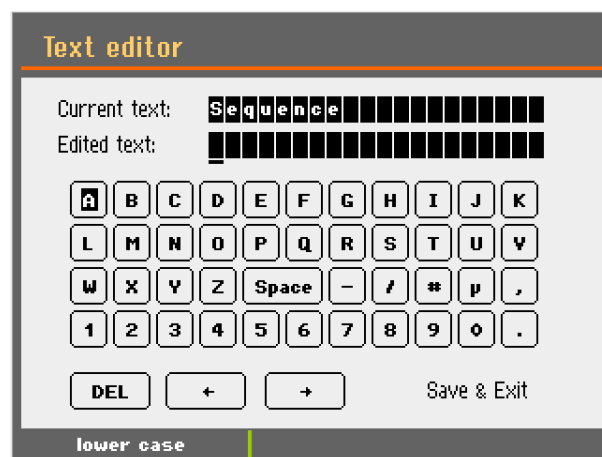

- Select *Save & Exit* to return to Cutting sequences.

Single Cut

Single cut can be edited from the editing menu.

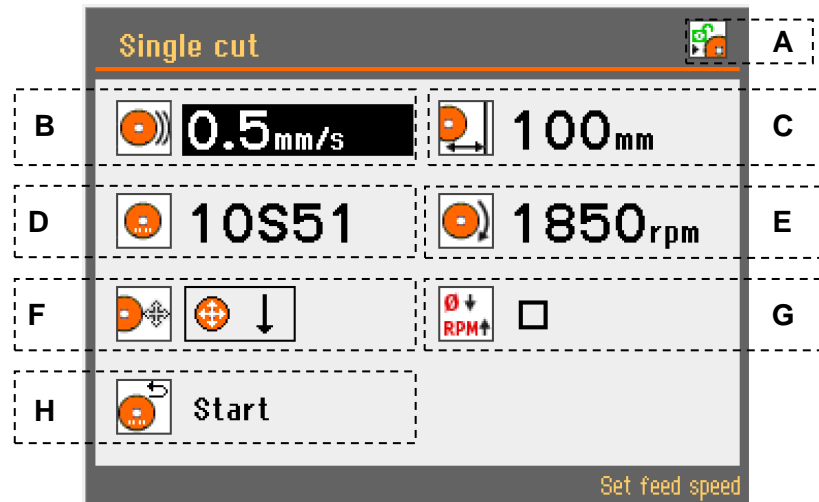

- | | | | |
|----------|---------------------|----------|---------------------|
| A | Spindle lock status | E | Cut-off wheel speed |
| B | Feed speed | F | Cutting mode |
| C | Cut Length | G | RPM compensation* |
| D | Cut-off wheel | H | Cut stop position |

*Only available with X-table and R-table option.

Editing the Parameters

The cutting parameters can be set both prior to and during cutting. From the *Cutting methods* menu, select a cutting method:

- Push knob to open the Single cut menu.

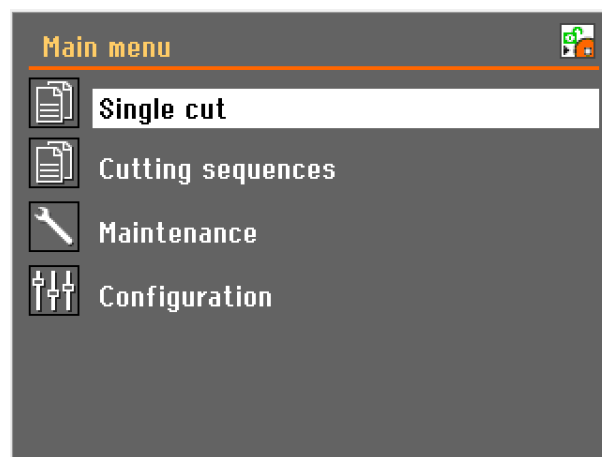

- Turn knob to highlight the parameter to be edited e.g. feed speed.

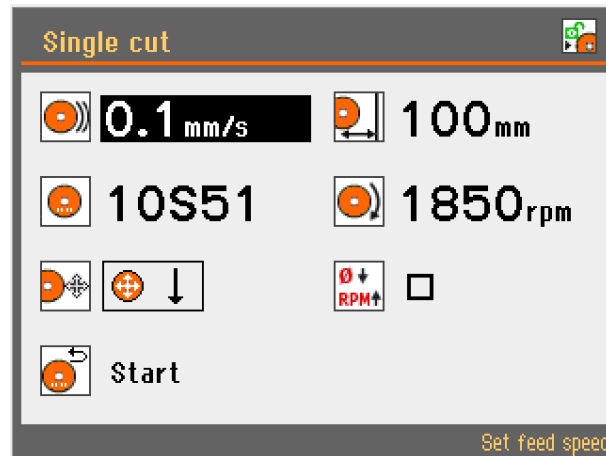

- Push knob to select the parameter.
- A scroll box appears.
- Turn knob to adjust the value of the parameter.



- Push knob to save the setting.

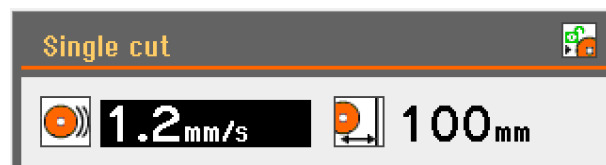

Feed speed



Can be set to values between 0.1 – 10 mm/s, in steps of 0.1 mm (4 – 394 mils, in step of 4 mi).

Default value: 0.5mm/s (2 mils)

Cut length



There are two ways to set the stop position: Setting a *Cut length* or *AutoStop*.

- Select **Cut-off wheel** and Push the knob.
- The Cutting *mode setup* menu will appear.

Setting a stop position

Can be set to values between 1 – 385 mm (0.04” – 15”), in steps of 1 mm (0.04”).

Default value: 100 mm (3.94”).



NOTE:

The available Cut length will differ depending on the cutting mode used. If the value selected is greater than this, a message will appear suggesting the Cut length which is available.

Cut length can also be set when editing the Cutting mode.

AutoStop

Adjust the stop position to '0'mm (Auto).

When the *AutoStop* function is selected, the machine automatically stops when the workpiece has been cut through.

See the section on **Stop Settings** in the **Reference Guide** in the Instruction Manual for advanced use.

Cut-off wheel



- Select **Cut-off wheel** and Push the knob.
- Select the cut-off wheel from the pop-up menu. When Wheel Selection Mode is set to 'Intelligent', the *Material guide* menu will appear.

Select the hardness of your Material in the pop-up menu and Magnutom will suggest the suitable Struers cut-off wheel, and automatically retrieve the recommended rotational speed for that specific wheel.



- Select the diameter of the cut-off wheel: 432 or 508 mm (17” or 20”).

Wheel Speed



Can be set to values between 1,000 – 1,850 rpm in steps of 50 rpm.

Default value: 1,850 rpm.

Cutting Mode



4 cutting modes are available:

Cutting mode can also be selected in the *Cutting mode setup* menu when editing the Cut length.

Icon	Cutting Mode	Typical use:
	Z Vertical cut	Vertical cut-length can be set. Cutting of larger samples
	Y Horizontal cut.	Horizontal cut-length can be set. Cutting of smaller samples
	Z+Y Combined cut	Vertical and Horizontal cut-length can be set. Cutting of extra-large samples
	AxioCut Combined cut	Combined cut. Cutting of extra-large and extra hard samples:- the cut-off wheel moves downwards in predefined steps



NOTE:

Maximum cutting capacity is achieved using **Y+Z** or **AxioCut**

See the section on **AxioCut** in the **Reference Guide** in the Instruction Manual for advanced use.

Cutting Sequence

Cutting sequence can be edited from the Cutting sequence editing menu.

Different Cutting sequences available.

Cutting sequence menu

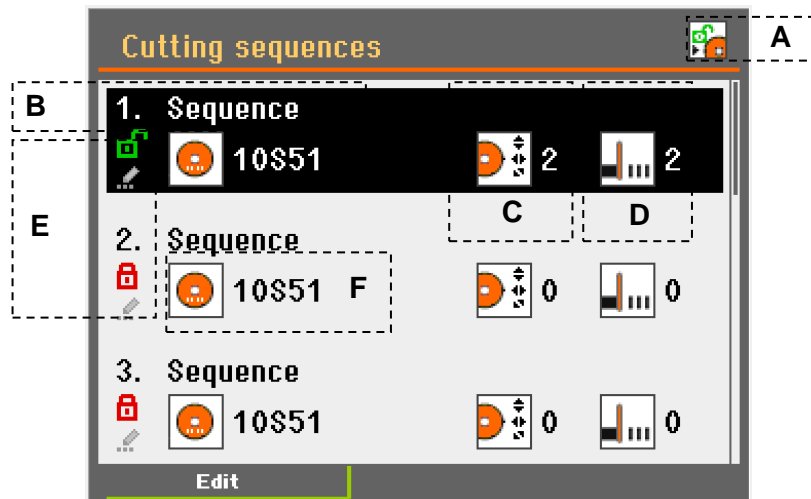

- | | | | |
|----------|----------------------------------|----------|--------------------------------|
| A | Spindle lock status | D | Number of cutting steps |
| B | Cutting sequence number and name | E | Cutting method locked/unlocked |
| C | Number of moving steps | F | Type of Cut-off wheel |

New Cutting Sequence

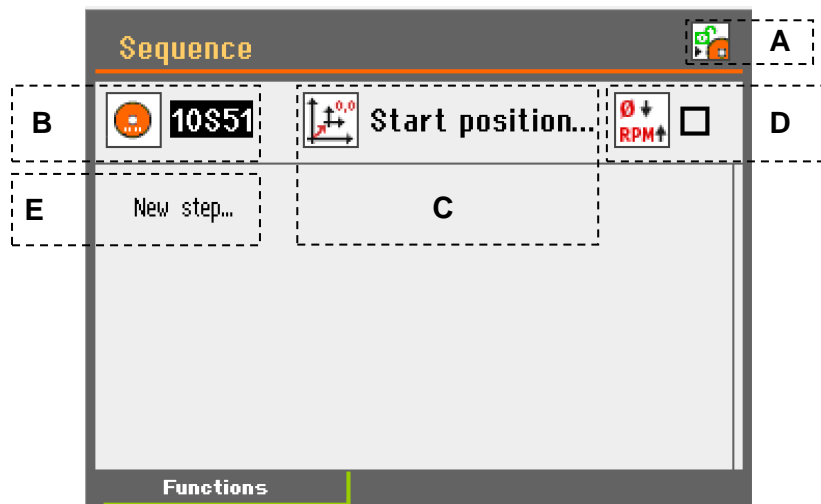

- | | | | |
|----------|------------------------|----------|-------------------|
| A | Spindle lock status | D | RPM compensation* |
| B | Cut-off wheel | E | New step menu |
| C | Cutting start position | F | |

*Only available with X-table and R-table option

New Cutting sequence programming

Follow these steps:

- Push knob to open the editing menu.

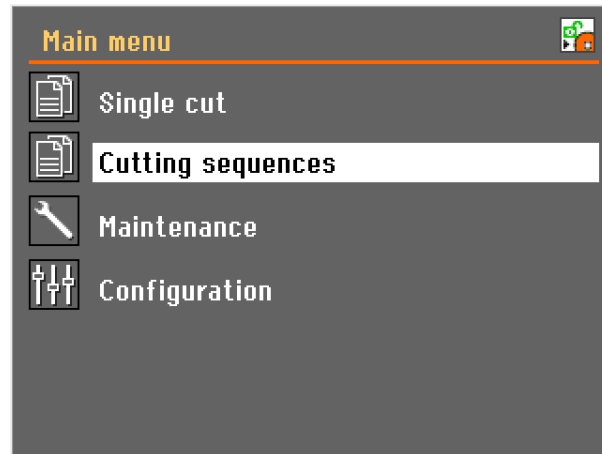

- Turn knob to select Cutting sequence
- Push knob to open selected Cutting sequence

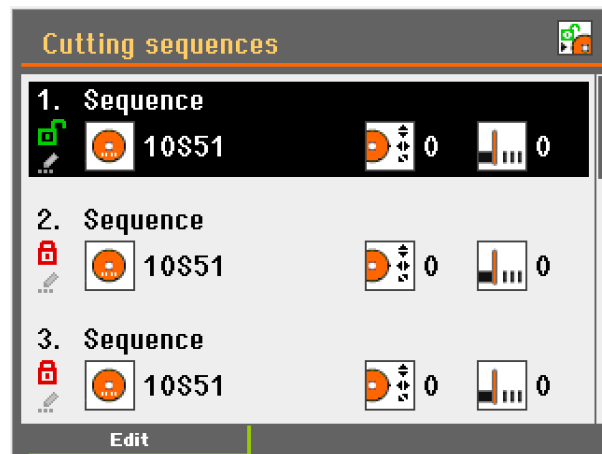

- New Cutting sequence screen appears



- Turn knob to highlight the parameter to be edited e.g. cut off wheel

Cut-off wheel



- Select **Cut-off wheel** and Push the knob.
 - Select the cut-off wheel from the pop-up menu.
 - When Wheel Selection Mode is set to 'Intelligent', the Material guide menu will appear.
 - Select the hardness of your Material in the pop-up menu and Magnutom will suggest the suitable Struers cut-off wheel, and automatically retrieve the recommended rotational speed for that specific wheel.



- Select the diameter of the cut-off wheel: 432 or 508 mm (17" or 20").

Start position



- Select **Start position** and Push the knob.
Start position can be taken from Current position, or can be set up as Absolute (value added manually)



Move to start position

Select **Move to start position** to

Capture current position



Select **Capture current position** to copy current Cut-off wheel and table position and save their values.

RPM compensation



■ Select **RPM compensation** and Push the knob.
By turning on RPM compensation, cutting RPM will be automatically adjusted, to keep optimal cutting parameters. (available only for Struers Cut-off wheels)

New Cutting sequence programming

Follow these steps:

- Turn knob to get to New step
- Push knob
- Turn knob to select Movement, Cutting or Pause step

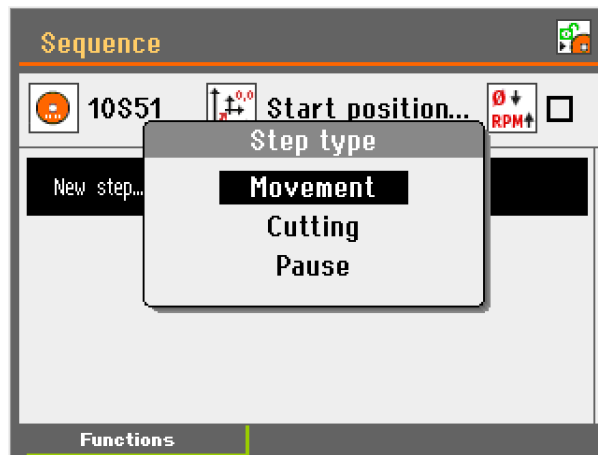

- Push knob to select Movement step

New Movement step

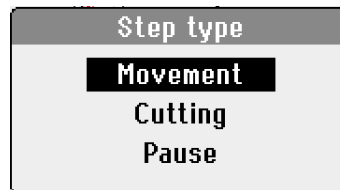

- Turn knob to get to adjust movement values



- Press Esc ↵ to get to Main menu

Safe move

Selet **Safe move** to help avoiding collision with workpeace during movemet. Cut-off wheel will firstly go to top rear position, than table adjust (rotate and move) to requested position.

Default value: ON



NOTE:

Struers always recommend to use Safe move

NOTE:

Using safe move will not ensure no collision.

Capture current position

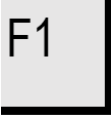

Select **Capture current position** to copy current Cut-off wheel and table position and save their values.

New Cutting step

Follow these steps:

- Push knob to select Cutting step

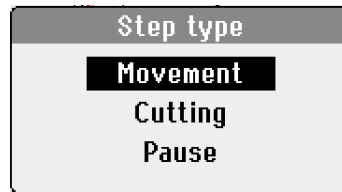

- Turn knob to adjust parametres

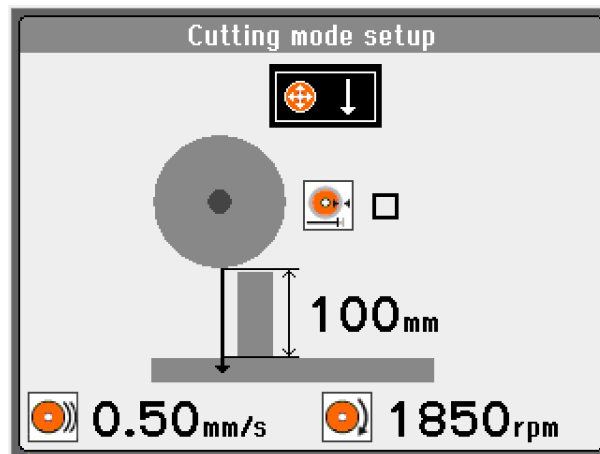

Cutting Mode



4 cutting modes are available:

Cutting mode can also be selected in the *Cutting mode setup* menu when editing the Cut length.

Icon	Cutting Mode	Typical use:
	Z Vertical cut	Vertical cut-length can be set. Cutting of larger samples
	Y Horizontal cut.	Horizontal cut-length can be set. Cutting of smaller samples
	Z+Y Combined cut	Vertical and Horizontal cut-length can be set. Cutting of extra-large samples
	AxioCut Combined cut	Combined cut. Cutting of extra-large and extra hard samples: the cut-off wheel moves downwards in predefined steps.



NOTE:

Maximum cutting capacity is achieved using **Y+Z** or **AxioCut**

See the section on **AxioCut** in the Reference Guide in the Instruction Manual for advanced use.

Feed speed



Can be set to values between 0.1 - 10 mm/s, in steps of 0.1 mm (0.004 – 0.4 mil/s).

Default value: 0.5 mm/s (0.02 mil/s)

Cut length



There are two ways to set the stop position: Setting a *Cut length* or *AutoStop*.

- Select **Cut-off wheel** and Push the knob.
- The *Cutting mode setup* menu will appear.

Setting a stop position

Can be set to values between 1 – 385 mm (0.04 – 15.16”), in steps of 1 mm.

Default value: 100 mm (4”).



NOTE:

The available Cut length will differ depending on the cutting mode used.

If the value selected is greater than this, a message will appear suggesting the Cut length which is available.

Cut length can also be set when editing the Cutting mode.

AutoStop

Adjust the stop position to '0'mm (Auto).

When the *AutoStop* function is selected, the machine automatically stops when the workpiece has been cut through.

See the section on **Stop Settings** in the **Reference Guide** in the Instruction Manual for advanced use.

Cut-off wheel



- Select **Cut-off wheel** and Push the knob.
- Select the cut-off wheel from the pop-up menu.
When Wheel Selection Mode is set to 'Intelligent', the *Material guide* menu will appear.
Select the hardness of your Material in the pop-up menu and Magnutom will suggest the suitable Struers cut-off wheel, and automatically retrieve the recommended rotational speed for that specific wheel.



- Select the diameter of the cut-off wheel: 432 or 508 mm (17" or 20").

Wheel Speed



Can be set to values between 1,000- 1,850 mm in steps of 50 rpm.
Default value: 1,850 rpm.

New Pause step

Follow these steps:

Push knob to select Pause step

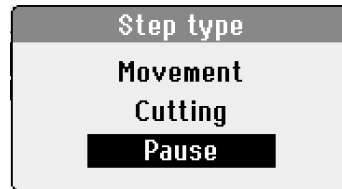

- Push knob to adjust value
- Turn knob to adjust the value of the parameter

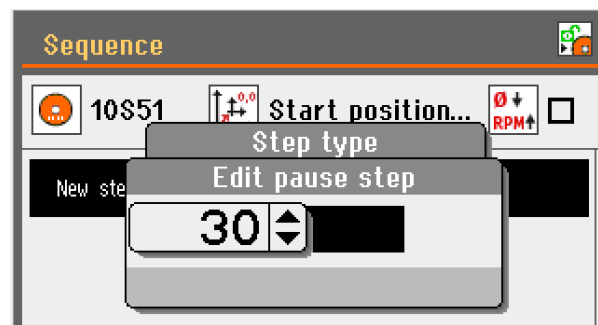

- Push knob to confirm value

Clamping the Workpiece

- Move the cut-off wheel backwards to the rear of the cutting chamber for optimum access to the cutting table.
- Clamp the workpiece with the clamping device of your choice e.g. a quick clamping device.
 - Place the workpiece between the clamp and the backstop.
 - Push the clamp towards the workpiece, and lock the quick clamping device with the locking handle.
- Ensure that only one of the quick clamping devices is tight, the other device should only press lightly.
Use support tools if the geometry of the workpiece makes support necessary.



CRUSHING HAZARD

Use safety shoes when handling large or heavy workpieces.



NOTE:

The Max load on the X-table is 150 kg / 330 lbs.
The Max load on the R-table is 150 kg / 330 lbs.

Before starting to cut, check that the cut-off wheel or cut-off wheel guard will not come into contact with the clamping device during the cutting process.

When using Serial cutting sequences, check that the cut-off wheel will not be obstructed by the workpiece or the clamping device during its X-axis and Rotary movement.



NOTE:

To avoid contact between cut-off wheel and clamping device, run SIMULATION function before Serial cutting sequence.

Cutting on Magnutom

Starting the Cutting

AutoCut: Off

See the section on **AutoCut** in the **Reference Guide** in the Instruction Manual for advanced use.

- Position the cut-off wheel by slowly moving it to within 1 - 2 mm (0.04 – 0.08”) of the sample.



NOTE:

Take care when moving the cut-off wheel. If moved too quickly and it comes into contact with the workpiece, it is possible that the cut-off wheel will break.

- Close the protection hood.
- Press START .
 - The cut-off wheel starts rotating, the cooling fluid starts running and the cut-off wheel will slowly move down into the workpiece at the pre-set Feed speed.



CRUSHING HAZARD

Keep fingers clear of door frames when closing the doors.



CAUTION

Use working gloves as workpieces and specimens may be both very hot and produce sharp edges.

AutoCut: Simple

- Press START .
 - The cut-off wheel will advance towards the workpiece at a maximum speed of 5 mm/s (0.2 mil/s).
 - After contact with the workpiece, the cut-off wheel is automatically retracted 2 mm, to be ready for cutting.
 - The cut-off wheel will then continue to move into the workpiece at the pre-set Feed speed.

AutoCut: Program

When AutoCut has been pre-programmed:

- Press START .
 - The cut-off wheel will advance at high speed to the pre-programmed start position.
 - After reaching this position the speed is reduced until contact is made with the workpiece.
 - After contact with the workpiece, the cut-off wheel is automatically retracted 2 mm (0.08”), to be ready for cutting.
 - The cut-off wheel will then continue to move down into the workpiece at the pre-set Feed Speed.

The Cutting Process Screen

The Cutting process screen shows information about the cutting process including:

- Cutting Parameters
- Motor Information
- Cutting Mode and a Countdown timer

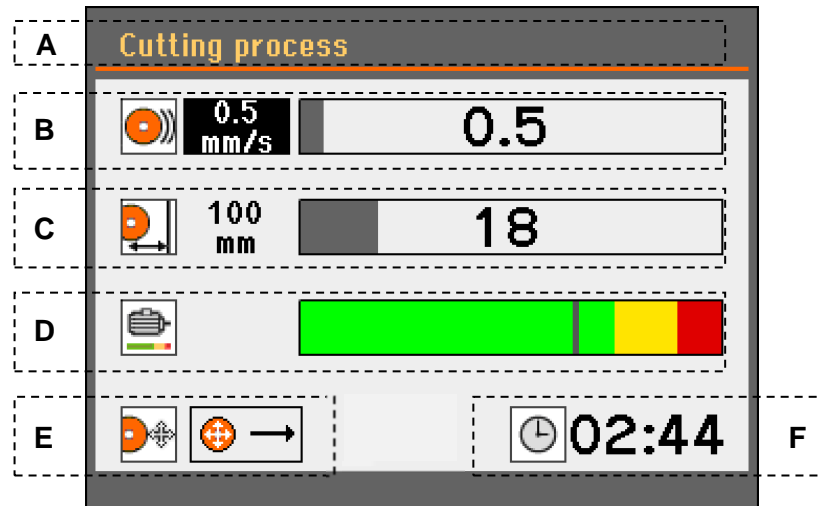

- | | | | |
|---|---------------|---|-----------------|
| A | Heading | D | Motor load |
| B | Feed speed | E | Cutting Mode |
| C | Length of cut | F | Timer Countdown |

Feed speed

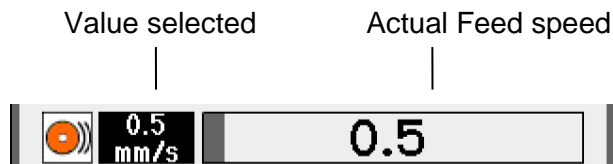

Length of cut

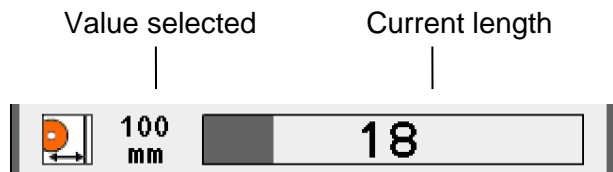

Motor load



Cutting Mode



Cutting mode



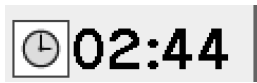

Timer Countdown



An estimate of time remaining for the cutting process.
(When AutoStop is selected, a countdown timer will not be displayed.)

Manual Stop

Magnutom automatically stops cutting when the workpiece is cut through but can be stopped at any time during operation by pressing STOP .

- Press STOP  to manually interrupt the cutting process.

Re-starting cutting

- Press START  to resume cutting.

Additional Cooling

When cutting hollow and/or thin workpieces, two flexible water jets are provided for workpiece cooling.

- Position the cooling jets to the left and right of the cutting area.

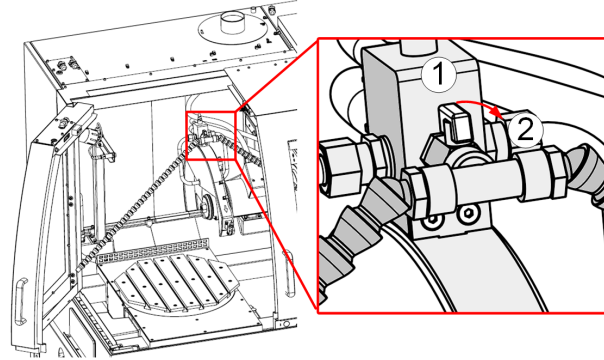

- Open the valve (position ②) to activate the cooling jets. The cooling liquid will flow as soon as the cutting starts.
- When cutting is finished, close the valve (position ①).



NOTE:

When using the flexible water jets, cooling liquid is diverted from the integrated water jets positioned over the cut-off wheel. The flexible water jets should not be used when cutting workpieces of large diameter as cooling will be less efficient. They are designed to supply a more localized cooling e.g. the internal surface of hollow workpieces.

3. Maintenance

Proper maintenance is required to achieve the maximum uptime and operating lifetime of the machine. Maintenance is also important in ensuring Magnutom's continued safe operation.

The maintenance procedures described in this section must be carried out by skilled or instructed persons.

General Cleaning

To ensure a longer lifetime for your Magnutom, Struers strongly recommends daily cleaning of the cutting chamber.

Clean the cutting chamber thoroughly if the Magnutom is not to be used for a longer period of time.



NOTE:

Accumulated dirt and swarf can restrict or cause damage to the movement of the cutting arm or X-table (if this option is installed).

Recirculation Cooling Unit

For Maintenance of the *Recirculation Cooling Unit*, please refer to the Recirculation Cooling Units Instruction Manual.

Daily Machine

- Clean all accessible surfaces with a soft, damp cloth.



HINT:

Do not use a dry cloth as the surfaces are not scratch resistant. Grease and oil can be removed with ethanol or isopropanol.



CAUTION

Never use acetone, benzol or similar solvents.

AxioWash

The AxioWash cleaning program is an efficient way to automatically clean the cutting chamber. The following parameters can be adjusted: time, cut-off wheel movement or X-table movement (with X-table option).

Time

Can be set to values between 30 sec - 30 min, in steps of 30sec.
Default value: 15 minutes

Cut-off wheel movement

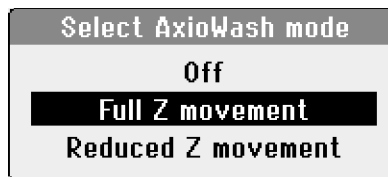

Mode	Result
Off:	Cut-off wheel arm stays in the current position.
Full Z movement	Cut-off wheel arm cycles backwards and forwards and between the lowest and the highest Z position.
Reduced Z movement	Cut-off wheel arm cycles backwards and forwards and between two Z positions – the z-position of the cut-off wheel arm when AxioWash is started and the highest Z position.



HINT:

Reduced Z movement is useful as it does not require the clamping tool or workpiece to be removed before AxioWash. Before using this AxioWash function, move the cut-off wheel to the lowest Z position where there will be no collision with clamping tools/ workpiece.

X-table movement

When an X-table is fitted, AxioWash can be programmed to run with X-table movement set to **On** or **Off**.



Off

- Clean the cutting chamber.

Cleaning the Cutting Chamber

- Clean the cutting chamber , especially the cutting table the T-slots and the bellows.
Clean automatically (using AxioWash) and then manually (using the flushing gun).

Automatic cleaning: AxioWash

To start the AxioWash function:

- Remove the workpiece and tools from the cutting chamber.
- Close the adjustable cleaning nozzles.
- Close the protection hood and the side door.
- Press the AxioWash key on the Control Panel to activate the AxioWash PopUp.
If required, adjust the AxioWash parameters - time, cut-off wheel movement or X-table movement – then press the AxioWash key again to start cleaning.
The AxioWash program will then run for the preset time.

Manual cleaning

When AxioWash is finished:

- Press the Flush key on the control panel to activate the recirculation pump.
- Lift the flushing gun from its holder.
- Point the flushing gun towards the bottom of the cutting chamber.
- Turn on the water by pressing the rear of the nozzle.
- Clean the cutting chamber thoroughly.
 - Clean the spaces between the T-slots on the cutting table.
 - Clean the space around the cutting table.
 - Clean the bellows thoroughly, in particular the folds where swarf can accumulate.
- Turn off the water by pressing the Flush key again.
- Return the flushing gun to its holder.



CAUTION

- Wear gloves and goggles when using the flushing gun. The fluid is contaminated with metal particles and may be hot, too.
- Risk of wet floor/ slipping hazard.
Do not clean the roof of the cutting chamber or directly on the doors with the flushing gun.

Maintenance of Cut-off Wheels

Storage of Bakelite Bonded Al₂O₃ Cut-off Wheels

This type of cut-off wheel is sensitive to humidity. Therefore, do not mix new, dry cut-off wheels with used, humid ones. Store the cut-off wheels in a dry place, horizontally on a plane support.

Maintenance of Diamond and CBN Cut-off Wheels

The precision of diamond and CBN cut-off wheels (and thus the cut) depends on how carefully the following instructions are observed:

- Never expose the cut-off wheel to overload, such as heavy mechanical load, or heat.
- Store the cut-off wheel in a dry place, horizontally on a plane support, preferably under light pressure.
- A clean and dry cut-off wheel does not corrode. Therefore, clean and dry the used cut-off wheel before storing. If possible, use ordinary detergents for the cleaning.

Weekly

The machine should be cleaned regularly, in order to avoid damaging effects to the machine and the specimens from abrasive grains and metal particles.

- Clean painted surfaces, and the control panel with a soft damp cloth and common household detergents. For heavy duty cleaning, use Struers Cleaner.
- Clean the cover with a soft damp cloth and a common household anti-static window cleaning agent. Do not use harsh or abrasive cleaning agents.



NOTE:

Ensure that no detergent or cleaning agent residue is flushed into the cooling unit tank; excess foaming will occur.

Cleaning the Cutting Chamber

- Remove the clamping device(s).
 - Thoroughly clean and lubricate the clamping device(s).
 - Store the clamping device(s) in a dry place or replace on the cutting table after cleaning.
- Clean the cutting chamber thoroughly:
 - Remove the grates at the rear of the cutting chamber and clean.
 - Clean along the length of the guide shafts with the flushing gun and a brush to remove accumulated swarf.
 - Clean under the cutting table with the flushing gun and a T-slot cleaner (Cat. No. 05486910) or brush to remove accumulated swarf.

Cooling Unit

- Check the level of the cooling liquid after 8 hours use or at least every week.

Monthly

Replacing the Cooling Fluid

- Replace the cooling fluid in the Recirculation Cooling Unit at least once a month.

Lubricating the Movement Mechanisms

Magnutom is equipped with an automatic lubrication system for the movement mechanisms.

X-Table Models (option)

To perform lubrication of the X-table:

Optical sensor cleaning

Limescale to be removed once per 6 months.
Use a suitable agent and soft cleaning rag. Do not scratch it.

Maintenance of Clamping Devices



NOTE:

It is recommended to thoroughly clean and lubricate the Quick Clamping Device and Vertical Quick Clamping Device at regular intervals.

Maintenance of the Clamping Devices is part of the regular yearly Struers Service.

Maintenance of Cutting Table

The stainless steel bands forming the cutting table should be replaced if they have become worn or damaged. The bands are available as spare parts.

To allow humidity to escape from the cutting table and chamber, it is recommended to leave the hood open when the machine is not in use.

Lubricating the Cutting Table
Part of Struers ServiceGuard

To maintain the optimum performance of Magnutom, lubricate the cutting table at regular intervals (approx every 100 hours).
Check the service info displayed on the screen at start-up to monitor the actual number of usage hours.
After lubrication of the x-table, note the date and number of service hours on the Maintenance Log table.

Yearly
Inspection of Cover

The protective cover consists of a metal frame and a composite material (PETG) screen that protects the operator.

- Visually inspect the cover and the screen for signs of wear or damage (e.g. dents, cracks, damage to edge sealing).



CAUTION

Carry out inspection at more regular intervals if Magnutom is used for more than one 7 hour shift a day.

Replacing the Screen in the Cover

Part of Struers ServiceGuard

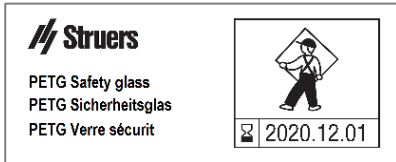

To ensure its intended safety, the PETG screen must be replaced every 5 years³. A label on the screen indicates when it is due to be replaced.

The cover screen should be **replaced immediately** if it has been weakened by collision with projectile objects or if there are visible signs of deterioration or damage.

Inspection of the cover and replacement of the screen are part of ServiceGuard, the Struers range of service plans.

Testing Safety Devices

The safety system must be tested once per year.



The doors have a safety switch system to prevent the cut-off wheel from starting while the cover is open. Furthermore, a locking mechanism prevents the operator from opening the doors until the cut-off wheel stops spinning.





NOTE:

Remember to test both the front door and the side door.

- Start a cutting process.
- Activate the Emergency-stop.
If cutting does not stop, press STOP  and contact Struers Service.

- Activate the Emergency-stop.
Press START .
If cutting or the recirculation pump starts, press STOP  and contact Struers Service.

- Start a cutting process.
- Open a door. Do NOT use force.
If the door opens, press STOP  and contact Struers Service.

- Open the door
- Press start .
If cutting and recirculation pump start, press STOP  and contact Struers Service.

- Open the door
- Use the joystick to move the cutting table.
If the cutting table moves, contact Struers Service.

³ Replacement after 5 years of the screen is required due to material deterioration.



WARNING

Do NOT use the machine with defective Safety Devices.
Contact Struers Service.



WARNING

Use a padlock to secure the main switch during repair.

4. Cautionary Statements



WARNING

When lifting the machine by the built-in truck lifting point, ensure that the boom is properly secured with the locking pins provided.



ELECTRICAL HAZARD

- Switch the power off when installing electrical equipment.
- The machine must be earthed.
- Check that the mains voltage corresponds to the voltage stated on the type plate on the side of the machine.
Incorrect voltage may result in damage to the electrical circuit.



CAUTION

Prolonged exposure to loud noises may cause permanent damage to the hearing,
Use hearing protection if exposure to noise exceeds levels set by local regulations.



CAUTION

During cutting, the cooling fluid coming out of the water outlet may be very hot.



CRUSHING HAZARD

Keep hands clear of X-table while positioning it.



CRUSHING HAZARD

Keep hands clear of R-table while positioning it.



WARNING

Check that the safety latch is untampered with and operational before cutting.



CRUSHING HAZARD

Use safety shoes when handling large or heavy workpieces.



CRUSHING HAZARD

Keep fingers clear of door frames when closing the doors.



CAUTION

Use working gloves as workpieces and specimens may be both very hot and produce sharp edges.



CAUTION

Never use acetone, benzol or similar solvents.



CAUTION

- Wear gloves and goggles when using the flushing gun. The fluid is contaminated with metal particles and may be hot, too.
- Risk of wet floor/ slipping hazard.
Do not clean the roof of the cutting chamber or directly on the doors with the flushing gun.



CAUTION

Carry out inspection at more regular intervals if Magnutom is used for more than one 7 hour shift a day.



WARNING

Do NOT use the machine with defective Safety Devices.
Contact Struers Service.



WARNING

Use a padlock to secure the main switch during repair.



WARNING

In case of fire, alert bystanders, the fire brigade and cut power.
Use a powder fire extinguisher. Do not use water.



WARNING

The PETG screen must be replaced after a lifetime of 5 years.
Other Safety critical components are to be replaced as required,
depending on the wear on the machine, but must be replaced at
after a maximum lifetime of 20 years.

5. Disposal

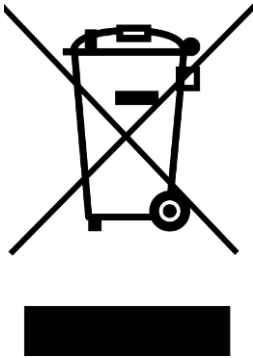

Equipment marked with a WEEE symbol  contains electrical and electronic components and must not be disposed of as general waste.

Please contact your local authorities for information on the correct method of disposal in accordance with national legislation.



NOTE:

Swarf must be disposed of according to the current safety regulations for handling and disposal of swarf/ additive in the cooling fluid.

NOTE:

The cooling fluid will contain additive and cutting swarf and may NOT be disposed of into a main drain.

Cooling fluid must be disposed of in compliance with local safety regulations.

Depending on which metals are being cut, it is possible that the combination of the metallic swarf (cutting debris) from metals with a large difference in electro positivity (a large distance apart in the electrochemical series), could result in exothermic reactions when 'favourable' conditions are present.

Therefore, it is always good practice to bear in mind which metals are being cut and the amount of swarf produced.

Examples:

The following are examples of combinations which could result in exothermic reactions if a large amount of swarf is collected during conditions are present:

Aluminum and Copper

Zinc and Copper

In case of fire, alert bystanders, the fire brigade and cut power. Use a powder fire extinguisher. Do not use water.



WARNING

In case of fire, alert bystanders, the fire brigade and cut power. Use a powder fire extinguisher. Do not use water.

Reference Guide

Table of Contents	Page
1. Advanced Operations	
Configuration Menu	68
User Options Menu	68
Changing Operation Mode	70
New Pass Code	71
Process Options Menu	72
Return position:	72
ExciCut	73
AxioWash time	73
Additional Cutting Distance (AutoStop)	73
AutoCut	74
Setting an AutoCut Position:	75
Water flow checking	76
Max. Z-axis position	76
Cutting start pos. Y	77
Cutting start pos. Z	77
Chamber flash warning	77
Signalling light	77
Signalling light sound	77
User Defined Cut-off Wheels Menu	79
Maintenance Menu	80
Service functions	80
Reset configuration	80
Cutting Actions	80
ExciCut	80
Changing the Cut-off Wheels During Serial Cutting Sequence	81
AxioCut Cutting Mode	82
Stop Settings	83
AutoStop	83
Additional Cutting Distance (AutoStop)	83
Cut length	83
Positioning Screen	84
Setting a Relative Zero Position	84
Removing a Relative Zero Position	85
Reference Positions	86

OptiFeed Function.....	86
Clamping Irregular Workpieces	87
Safety Features.....	88
Optimising Cutting Results	89
2. Struers Knowledge.....	90
3. Accessories	91
4. Consumables.....	92
5. Trouble-Shooting	94
Error Messages.....	97
Messages.....	97
Errors.....	97
6. Service	
Service Information	109
Lubricating Moving Parts.....	109
7. Legal and Regulatory	
FCC Notice	111
EN ISO 16089:2015.....	111
IEC 61000-3-12.....	111
EN ISO 13849-1:2015.....	111
8. Spare Parts and Diagrams	
Safety Related Parts of the Control System (SRP/CS)	112
Magnutom-5000 YZ	112
Magnutom-5000 XYZ.....	113
Magnutom-5000 XYZR.....	114
Diagrams.....	115
9. Technical Data.....	119
Mains Cable Specification	120
External Short Circuit Protection	120
Residual Current Circuit Breaker.....	120
Cutting Capacity.....	121

1. Advanced Operations

Configuration Menu

A number of different settings and parameters can be set or adjusted from the *Configuration* menu.

There are 3 under menus:

- User options
- Process options
- User defined cut-off wheels

User Options Menu



Default value: To re-set the setting to default value, press the F1 key on the Control Panel.

Display brightness:

The brightness of the display can be adjusted to suit individual preferences

Can be set between 20-100

Default value: 40

Language:

The language can be set to English (default), German, French, Spanish, Japanese, Chinese, Italian, Polish or Korean.

Keypad sound

Can be set to On or Off

Units:

The units displayed can be set to Metric (mm/s, mm) (default) or Imperial (mil/s, inch).

Number of methods

Up to 100 cutting methods can be stored.

The default number: 10.

Wheel selection mode

Can be set to Intelligent or Manual
Default value: Intelligent

Manual:	the cut-off wheel is selected manually from the selection tree in the <i>Edit method</i> screen
Intelligent:	a cut-off wheel is automatically suggested based on the material (hardness) selected by user. The recommended RPM and thickness is automatically set.

Operation mode:

It is possible to select three different operation modes:

Configuration:	Full functionality
Development:	No access to parameters in CONFIGURATION menu, except Display contrast
Production:	Access to START, STOP, <i>Stop position</i> and movement of cut-off wheel, and to Display contrast in the CONFIGURATION menu

Changing Operation Mode

To change the operation mode, go to the *Configuration* menu and then the *User Options* menu. Select **Operation mode** to access the *Operation mode* menu.

Follow these steps:

- Push knob to select Pass code

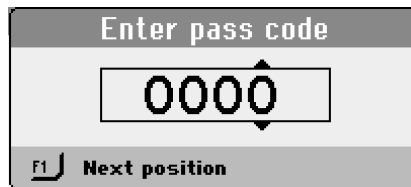

Use the F1 key and the knob to enter the current pass code (the default pass code is '2750'.):

- Use the F1 key to select digits.
- Turn knob to change the digits and press knob to enter the pass code.

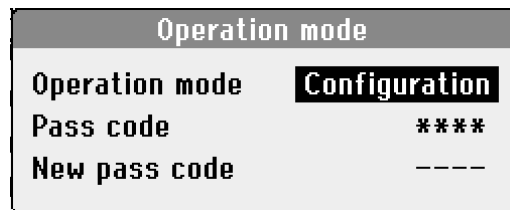

- Push knob to select **Configuration**



- Select the desired operation mode and push knob to confirm.

New Pass Code

A New pass code can also be selected from the *Operation mode* menu.

Operation mode	
Operation mode	Configuration
Pass code	****
New pass code	-----



NOTE:

When a pass code is set the operator has 5 attempts to enter the correct pass code after which the Magnutom will be locked.

Re-start Magnutom using the Main Switch then enter the correct Pass Code.

NOTE:

Remember to make a note of the new Pass code as settings can no longer be changed without the Pass code.

Process Options Menu

Process options	
Return position	Start
ExciCut	On
Excicut amplitude	1.5 mm
Excicut frequency	2.0 Hz
AxioWash time	15:00
Add. cut dist. (Autostop)	3 mm
AutoCut	Off

Default value

Return position:

After cutting or after pressing STOP , the return movement of the cut-off wheel can be set to three different functions:

Select return position
Start
Zero
Stay
Top & Rear

Mode	Result
Start	Magnutom automatically retracts the cut-off wheel to the original position of the cut-off wheel, at the time you pressed START  (default).
Zero	Magnutom automatically retracts the cut-off wheel to the rear of the chamber (cutting mode Y) or move up in the chamber (cutting modes Z, ZY, AxioCut).
Stay	The cut-off wheel stays in position after the cut is completed.
Top & Rear	Magnutom automatically retracts the cut-off wheel to the rear of the chamber and to its top position.



NOTE:

Use the *Stay* function for bakelite bonded diamond or CBN cut-off wheels, as retraction might destroy the rim of the cut-off wheel.

NOTE:

When using Serial cut sequence the *Stay* function cannot be used.

ExciCut

ExciCut cutting action can be set to On or Off.
Default value - On

Both the **amplitude** and the **frequency** of the ExciCut action can be tailored to provide optimal cutting of specific workpieces:

ExciCut amplitude	Can be set in the range 0.5 – 4mm, in steps of 0.5 Default value 1.5 mm
ExciCut frequency	Can be set in the range 0.2 – 2.5Hz, in steps of 0.1 Hz. Default value 0.5 Hz



HINT:

Change the amplitude and frequency values gradually and in small steps; the ExciCut action is very powerful and making larger adjustments in the values may result in damage to the workpiece or the cut-off wheel.

For further details on the *ExciCut cutting action*, see the section on [Cutting actions](#) on page 80.

AxioWash time

Can be set in the range 0.30 – 30:00 in steps of 0.30 minutes.
Default value 15 minutes

Additional Cutting Distance (AutoStop)

An additional distance can be set to ensure that the workpiece is completely cut through when the *AutoStop* is selected.
Can be set in the range 0 – 20 mm, in steps of 1 mm.
Default value: 2 mm

AutoCut

Can be set to Off, Simple or Program.
Default value – Off



Mode	Result
Off	The operator moves the cut-off wheel towards the workpiece before START \diamond is pressed.
Simple	The cut-off wheel will automatically move towards the workpiece at a maximum speed of 5mm/s when START \diamond is pressed. After contact with the workpiece, the cut-off wheel is automatically retracted 2 mm, to be ready for cutting. The cut-off wheel will then continue to move down into the workpiece at the pre-set Feed speed.
Program	When AutoCut is set to Program, the Edit method menu will change to indicate that a programmed AutoCut position is set. When an AutoCut position is set: The cut-off wheel will advance at high speed to the pre-programmed start position when START \diamond is pressed. After reaching this position the speed is reduced until contact is made with the workpiece. After contact with the workpiece, the cut-off wheel is automatically retracted 2 mm, to be ready for cutting. The cut-off wheel will then continue to move into the workpiece at the pre-set Feed speed.

The main purpose of AutoCut is for cutting of large/long workpieces where the cutting arm preferably should be at the far back while loading. The programmable Return Position is set to Top & Rear for maximum access. In order to make the cut as quickly as possible, the start position (just ahead of the workpiece) can be set using AutoCut Program.



HINT:

AutoCut is automatically set to Off whilst using MultiCut, to avoid damage to the cut-off wheel and workpiece.

Setting an AutoCut Position:

Follow these steps - from the *Edit method* menu:

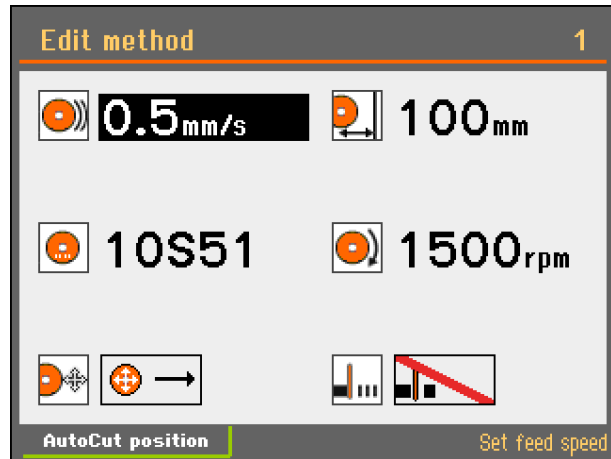

- Press the F1 key
The *AutoCut* pop-up screen will appear (note: AutoCut must be set to Program from the Process options menu)

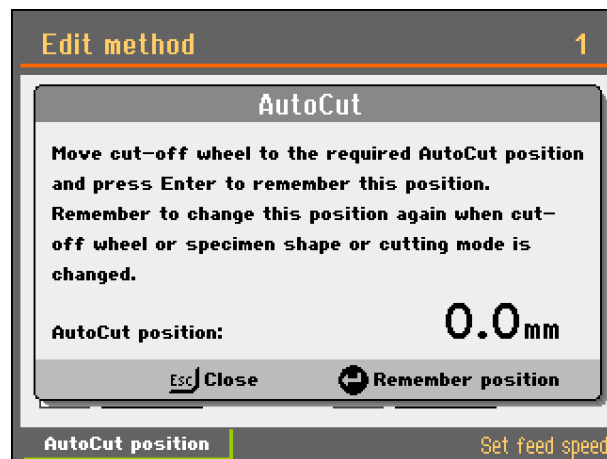

- Use the Joystick to move the cut-off wheel to the required AutoCut start position.
Press Esc  to leave the menu without changing the AutoCut start position.
- Push knob to set the AutoCut start position to the present position of the cut-off wheel.

Process options	
Water flow checking	On
Max. Z-axis position	230 mm
Cutting start pos. Y	Off
Cutting start pos. Z	Off
Chamber flash warning	Disabled
Signalling light	Disabled
Signalling light sound	Off

Default value



NOTE:

AutoCut position is set for the current cutting mode selected.

If cutting mode is then changed, the AutoCut position is automatically reset to zero (for safety reasons).

When AutoCut position is set to 0.0mm, AutoCut Program will function in the same way as AutoCut Simple.

Water flow checking

Can be set to On or Off

Default value - On

When Water flow checking is set to On, the flow of cooling liquid is checked at the start of and during a cutting process. If the water flow is below a set value, then the cutting process will be stopped.

Water flow checking Off can be used to continue operating Magnutom if the water flow is adequate but the flow sensor is not measuring correctly.

Max. Z-axis position

Can be set to Off or between 100 to 240 mm

Default value – 240 mm

This can be used to limit the Z movement of the cutting arm. This function is useful when using special clamping devices or workpieces with irregular geometries.

To set a *Max. Z-axis position*:

- Mount the clamping tool.
- Use the joystick to position the cutting arm in the maximum Z position.
- Read the Abs. Z-value from Positioning screen and change the *Max. Z-axis position* in the Process options menu to this value.

Cutting start pos. Y Can be set to Off or between 0 to 385 mm
Default value - Off

Cutting start pos. Z Can be set between 0 to 230 cm or Off
Default value - Off

Setting the Cutting start position is useful when cutting workpieces of the same size.
When Start is pressed, the cut-off wheel will quickly move to the set position.

Chamber flash warning Can be set to On or Off
Default value - Off

Signalling light Can be set to On or Off
Default value - Off
Please refer to the section on [Signalling light](#) (option) on page 28 for details.

Signalling light sound Can be set to On or Off
Default value - Off
Please refer to the section on [Signalling light](#) (option) on page 28 for details.

Continuous simulation Can be set to On or Off
Default value – Off
When function is On, there is no need to confirm each cutting step in cutting sequence of simulation.

Too Small wheel warning Can be set to On or Off
Default value - On
This option enabled or disabled this feature from Process options.

Magnutom 5000
Instruction Manual

Wheel measurement interval

Can be set from 1 to 50

Default value - 1

Wheel measurement is requested after set numbers of cuts.

Wheel measurement mode

Can be set to Standard or X=0

Default value - Standard

In Standard mode is going to 0 position first Z and then Y axis and then return back to original position in opposite order.

In X=0 mode is going to 0 position all axis in this order Z,Y,X and then return back to original position in opposite order

User Defined Cut-off Wheels Menu

Up to 10 user cut-off wheels can be defined for use on Magnutom. The parameters for the wheel size, rotational speed and width can be set using the *Edit wheel* menu.

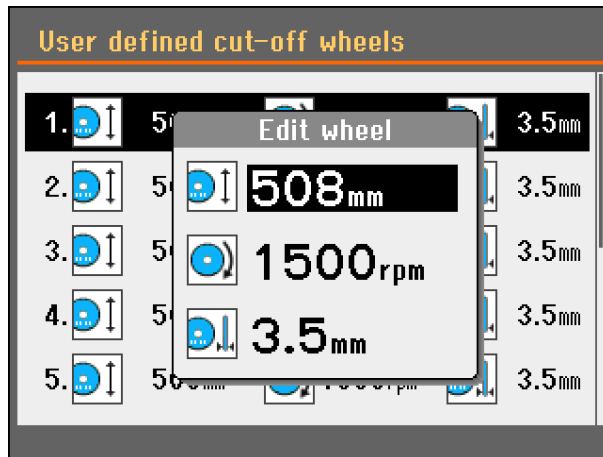

- | | |
|-------|--|
| Size | Can be set in the range 300 – 508 mm (12” – 20”)
Default value 508mm (20”)
Steps of 1 mm (4 mil) |
| RPM | Can be set in the range 1,000 – 1,850
Default value 1,850rpm |
| Width | Can be set in the range 1.0 – 6.0 mm (0.04 – 0.24”)
Default value 3.5 mm (0.14”)
Steps of 0.1 mm (2 mil) |

Maintenance Menu

The *Maintenance* menu has 2 under menus

- Service functions
- Reset configuration

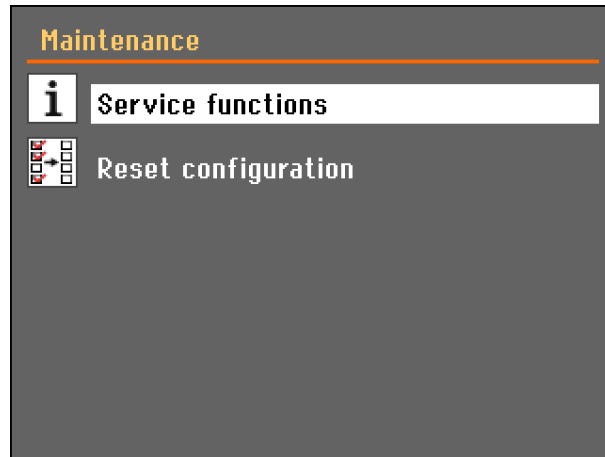

Service functions

Service information and statistics can be viewed in the **Service functions** menu.

Basic service functions can also be carried out.



NOTE:

The Service functions menus are in English only.

Using the same names/ terms is useful when communicating with your local Service Technician or Struers Customer Service department.

Reset configuration

Magnutom's user and process options can be set to default values by selecting **Reset configuration**. (The cutting methods and cut-off wheel database will be unaffected).

Cutting Actions

ExciCut

ExciCut cutting action is ideal for fast cutting of very hard materials (HV > 400). The oscillating movement of the cut-off wheel has two main advantages: there is less risk of damage to the workpiece and less risk of the motor overheating.

ExciCut is also recommended when cutting softer, non-hardened materials

ExciCut cutting action is selected as default for each Cutting mode.

The function can be disabled in the Configuration menu.

Changing the Cut-off Wheels During Serial Cutting Sequence

When cutting several specimens it may be necessary to change the cut-off wheel during a Serial cutting sequence.

- Press STOP  to manually interrupt the cutting process. The cut-off wheel arm goes to the start position.
- Change the cut-off wheel.
- Position the cut-off wheel approximately 1- 2mm above the workpiece.



NOTE:

Do NOT move the cut-off wheel back to its position immediately before STOP  was pressed.

When START is pressed, Magnutom registers this as a new start position and will return to this position after the cut is finished.

The cut-off wheel will be damaged if it is still inside the workpiece when the X-table moves to the next cut position.

- Press START  to resume cutting.
- A Pop-up will appear:
Press Enter to continue with the programmed MultiCut batch.



NOTE:

The cut-off wheel will start rotation and move towards the workpiece.

If desired, the process can be sped up by using the joystick (feed speed will be 3 times the preset feed speed).

AxioCut Cutting Mode



AxioCut cutting mode offers cutting of large and very hard materials. The vertical cut length and height of the workpiece can be set as well as the depth of each downwards step (in the example below, set to 5 mm).

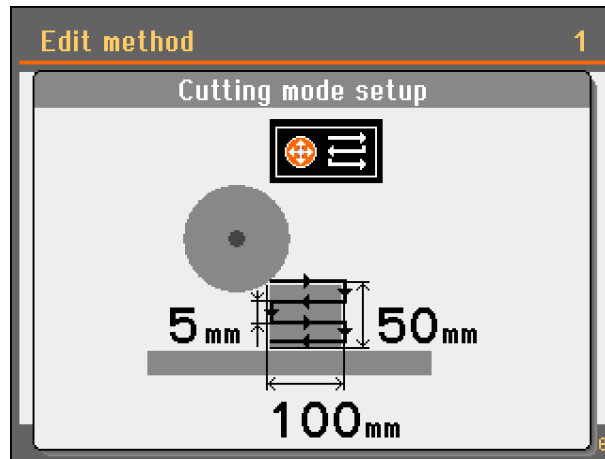

When in AxioCut cutting mode, the vertical feed speed is the same as the horizontal feed speed.



NOTE:

AxioCut does not function when AutoCut is selected.

Stop Settings

There are two ways to set the stop position: Setting a Cut length or *AutoStop*.

AutoStop



When the *AutoStop* function is selected, the machine automatically stops when the workpiece has been cut through. *AutoStop* is based on changes in the cutting motor load where a decrease in load indicates that the workpiece has been cut through.



NOTE:

Magnutom has a very powerful motor so small changes in the load may not be detected. As a result the *AutoStop* function may not detect when the workpiece has been cut through. This may particularly be the case when cutting soft materials, smaller workpieces, pipes or workpieces with changing cross-section or when cutting at low Feed Speeds.

If *AutoStop* does not work properly use the *Stop position* function instead or set an Additional Cutting Distance to compensate.

Additional Cutting Distance (AutoStop)

An additional distance can be set to ensure that the workpiece is completely cut through when the *AutoStop* function is used. This is important when using the MultiCut option.

An Additional cutting distance is set in the *Process options* menu.



NOTE:

When *AutoStop* is selected, a countdown timer will not be displayed.

Cut length

Cut length is used when a specific stop position is desired. When cutting pipes or other workpieces with changing cross sections, the cut-off wheel may retract before the workpiece has been cut through. To overcome this, a specific Cut length can be set.

- Clamp the workpiece and position the cut-off wheel just above the workpiece.
This position is automatically set to 0 (zero). Accordingly, as soon as Start has been pressed, the actual position of the cut-off wheel, becomes a relative starting point (zero), from where the cutting depth is calculated.
- Select the STOP parameter and set the desired stop position using the knob.
Magnutom will now stop when it reaches the pre-set stop position.
Remember to take the wear of the cut-off wheel into consideration.



Positioning Screen

The *Positioning* screen shows the Y and Z positions of the cutting arm and the X position of the X-table (with x-table option).

The screen is displayed for 3 seconds when the joystick has been activated.

- To keep the screen displayed (for up to 15 minutes), press the **F1** key.
- To close the screen, press Esc .



Absolute and Relative positions usually have the same value, but the user can define a new relative position, e.g. if there is a specific point on the workpiece that the user wants to set as 'zero position'.

Positioning				
	Abs.:	18.0 mm	<input type="checkbox"/>	Y - direction
	Rel.:	18.0 mm		
	Abs.:	42.0 mm	<input type="checkbox"/>	Z - direction
	Rel.:	42.0 mm		
	Abs.:	17.3 mm	<input type="checkbox"/>	X - direction
	Rel.:	17.3 mm		

Setting a Relative Zero Position

Follow these steps:

- Move the cursor to the rel.: position, then press **Enter**. This position (in the current example, Y position 18.0 mm) is now set as the new relative zero.

Positioning			
	Abs.:	18.0 mm	<input type="checkbox"/>
	Rel.:	0.0 mm	
	Abs.:	42.0 mm	<input type="checkbox"/>
	Rel.:	42.0 mm	
	Abs.:	17.3 mm	<input type="checkbox"/>
	Rel.:	17.3 mm	

When the cutting arm is moved, the relative position now shows the value in regard to the previously defined zero position.

Positioning			
	Abs.:	21.0 mm	<input type="checkbox"/>
	Rel.:	3.0 mm	

To return to the previously defined zero position:

- Move the cursor to the "Go to relative zero position" icon and press **Enter**.

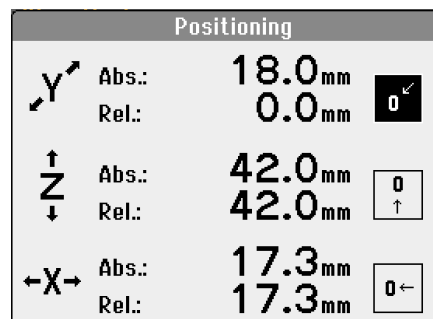
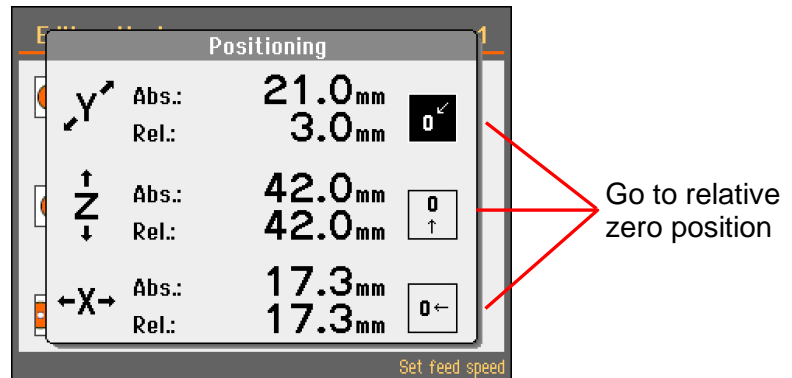

Removing a Relative Zero Position

- Move the cutting arm to *abs.:* zero position (0.0 mm).

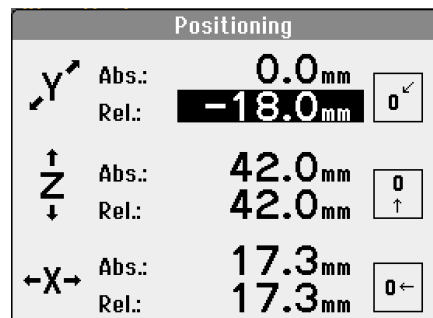

- With the cursor highlighting the *rel.:* position, press **Enter**.

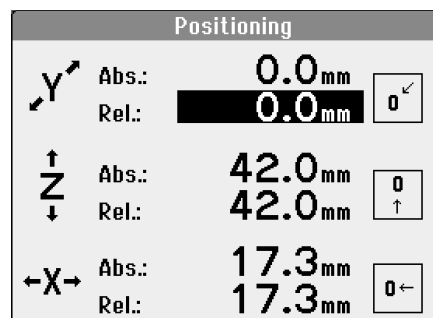

Reference Positions

Magnutom will perform a search for reference positions for every 20th start up.

To perform an additional reference search:

- Switch Magnutom off.
- Press the Emergency Stop button then switch Magnutom on (a message will appear to inform that the Emergency Stop is activated).
- Release the Emergency Stop and a pop-up will appear. Press Enter to start the search for reference positions.

OptiFeed Function

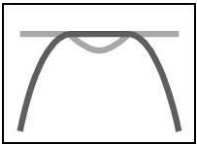

During cutting, Magnutom continuously measures the load on the cutting motor and force in the cutting arm.

The factors that determine the load are the shape and properties of the workpiece.

The OptiFeed function:- Whenever the maximum force or motor load is reached (150%), Magnutom will automatically reduce the Feed speed. As soon as the force or load drops below the set limit, the speed will be increased to the original setting.

The figure below illustrates the increase in force as the cut-off wheel gets closer to the centre of a round workpiece.

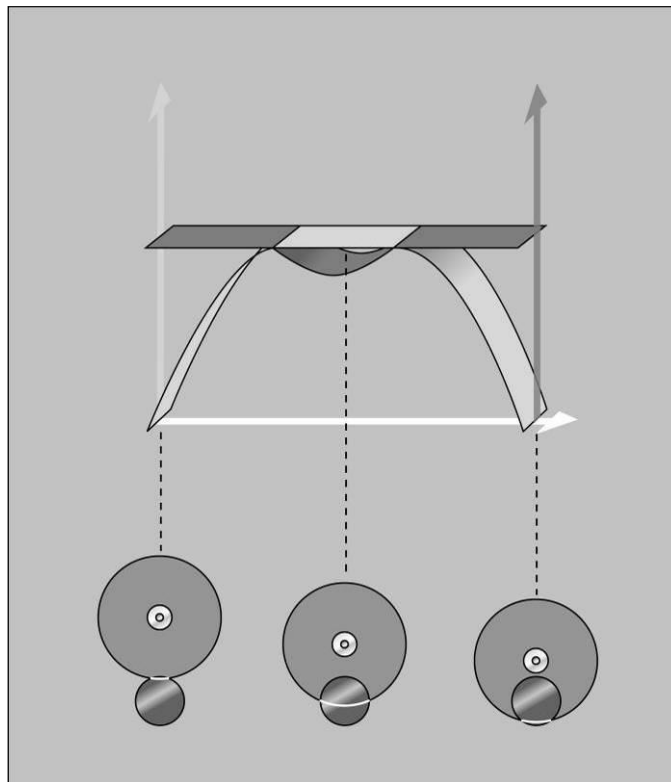

Clamping Irregular Workpieces

Irregular workpieces without plane clamping surfaces must be clamped using special clamping tools, as the workpieces must not move during cutting. This could result in damage to the cut-off wheel or to the sample itself. Use the T-slots to mount the special clamping tools. Struers offers a large selection of Clamping Tools (See Accessories).

To achieve faster cutting, position the workpiece so that the wheel will cut the smallest possible cross-section.

Removing the left cutting table
(models with fixed cutting table)

If required, the left side of the cutting table can be removed to make room for very large or irregular workpieces.

Safety Features

The machine's work zone guards are equipped with a guard interlocks to prevent the cut-off wheel from spinning while the guards are open. Furthermore, an interlock locking mechanism prevents opening of the guards before the cut-off wheel has come to a complete stop.

Work zone guards



Work zone guards can be opened only when the machine is connected to power and the main power switch is ON position.

To open the guards when the power is not connected, use the triangle key to mechanically disable the locking mechanism.

The safety lock release is placed on the top left corner of the machine, where the safety doors meet.

The interlock locking mechanism must be re-enabled before any operation with the machine.

The PETG safety glass in the guard window is designed to withstand flying fragments of cut-off wheel or samples.

A sticker located onto the window indicates when the glass should be replaced. Replace immediately if the window is damaged or cracked.

Hold-to-run control

In order to perform any movement or maneuver of the cut-off wheel or tables with work zone guards open a hold-to-run button must be pressed and held before operating the joystick.

Speed of the movements during a hold-to-run control is reduced to a safe limit and monitored in real time. Full movement speed can be achieved only with work zone guards closed.

Emergency stop

The emergency stop button is embedded onto the machine for any unexpected emergency situation.

All movements and sources of energy are stopped immediately after the emergency stop button is pressed.

Lockable main switch

When the main switch is turned OFF, a hole in the lock's housing can be used to attach a padlock or a plastic strip.

This is particularly useful during Servicing as it will prevent the machine from being energized before the Service is complete.

Motor overload/overheat

All motors are protected against overload and overheat scenario. Should the motors overheat and/or overload, the motors will disengage until a normal temperature has been obtained.

Optimising Cutting Results

The following table shows possible answers to a number of common questions:

Optimising the Cutting Results	
Question	Answer
How can I avoid discoloration or burning of the sample?	Use a lower Feed Speed.
	Change the cut-off wheel as the hardness of the present cut-off wheel may be inappropriate for the hardness of the sample ⁴ .
How can I avoid burrs?	Use a softer cut-off wheel ⁴ .
	Clamp the workpiece securely at the right hand clamping device. Tighten the left hand clamping device just enough to prevent the workpiece from moving when being cut.
How can I avoid the cut-off wheels wearing too quickly?	Use a lower Feed Speed, a different cutting mode or a harder cut-off wheel ⁴ .
How can I achieve faster cutting?	Position the workpiece so as to cut the smallest possible cross-section. Use a high Feed Speed.

⁴ Please refer to the Selection Guide in the [Struers Cut-off Wheels brochure](#).

2. Struers Knowledge

Materialographic sectioning is where most microstructure analysis begins. A good understanding of the abrasive cutting process can help to select suitable clamping and cutting methods and thereby ensure the high quality cut. Minimizing cutting artefacts will help the remaining materialographic process and act as a good base for efficient and high quality preparation.



HINT:

For further information, see the section on Cutting on the Struers website.

3. Accessories

Please refer to the [Magnutom brochure](#) for details of the range available.

Clamping Tools

Please refer to the [Struers Clamping Tools brochure](#) for details of the range available.

4. Consumables

The use of Struers consumables is recommended.

Other products (e.g. coolants) may contain aggressive solvents, which dissolve e.g. rubber seals. The warranty may not cover damaged machine parts (e.g. seals and tubes), where the damage can be directly related to the use of non-Struers consumables.

Cut-off Wheels

When *Wheel selection mode* is set to *Intelligent*, a cut-off wheel is automatically suggested based on the material (hardness) selected by the user.

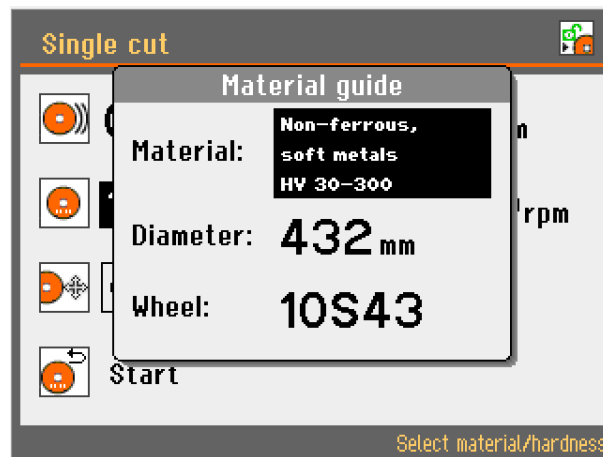

Alternatively, please refer to the Selection Guide in the [Struers Cut-off Wheels brochure](#) and [Struers Consumables Catalogue](#)

Magnutom 5000
Instruction Manual

Other Consumables

Cutting additives

More information can be found on Struers.com .

<https://www.struers.com/en/Knowledge/Cutting/7-ways-to-optimize>

5. Trouble-Shooting

Error	Explanation	Action
Machine Problems		
Water leaking.	Leak in recirculation water hose.	Check the hose and tighten the hose clamp.
	Water overflow in the Cooling fluid tank.	Remove the excess cooling fluid from the tank.
Samples or cutting chamber corroded.	Insufficient additive for cooling fluid.	Add Struers Additive for cooling fluid to the cooling fluid, using the correct concentration. Check with a refractometer. Follow the instructions in the Maintenance section.
	The machine is left with closed protection hood.	Leave the protection hood open to let the cutting chamber dry.
Quick-clamping device unable to hold the workpiece.	The quick-clamping device is not in balance.	Adjust the screw underneath the clamping column. Use a 3mm Allen key.
	Clamping heart worn.	Call a Struers Service Technician.
Door will not close	There is an obstruction in the cutting chamber.	Remove the obstruction.
Machine is locked	Incorrect Pass Code used.	Re-start machine using Main Switch. Enter the correct Pass Code. If error remains, contact a Struers Service Technician.

Magnutom 5000
Instruction Manual

Error	Explanation	Action
Cutting Problems		
Discoloration or burning of the sample.	The hardness of the cut-off wheel is inappropriate for the hardness / dimensions of the sample.	See Consumables section, Cut-off Wheels.
	Inadequate cooling.	Check that there is enough water in the recirculation cooling unit. Check the condition of the cooling tray.
	Feed Speed or RPM too high.	Reduce the Feed Speed or reduce the RPM.
Unwanted burrs.	Wheel too hard.	Reduce RPM to make wheel softer, or change to different wheel: See Consumables section, Cut-off Wheels.
	Insufficient support of workpiece.	Add further support to the workpiece.
The cutting quality differs.	Cooling liquid hose clogged.	Clean the cooling liquid hose and the cooling tubes. Check the water flow by turning the cooling valve to cleaning position.
	Insufficient cooling liquid.	Refill tank with water. Remember to add Struers Additive.
The cut bends to one side.	Feed Speed is too high.	Reduce the Feed Speed.
The cut-off wheel breaks.	Incorrect mounting of the cut-off wheel.	Check that the centre-hole has the correct diameter. Check cardboard washer on both sides of the cut-off wheel. The nut must be tightened properly.
	Incorrect clamping of the workpiece.	Make sure that only one of the quick-clamping devices is tight. The other device should only press lightly. Use support tools if the geometry of the workpiece makes support necessary.
	Wheel too hard.	See Consumables section, Cut-off Wheels.
	Feed Speed too high.	Reduce the Feed Speed.
	Inadequate cooling.	Check that there is enough water in the recirculation cooling unit. Check the cooling liquid hoses.
The cut-off wheel wears down too quickly.	Feed Speed too high.	Reduce the Feed Speed.
	Insufficient cooling.	Check that there is enough water in the recirculation cooling unit. Check the cooling liquid hoses.
	The cut-off wheel is too soft for the task.	See Consumables section, Cut-off Wheels.
	Magnutom vibrates (worn bearings).	Call a Struers Service Technician.

Magnutom 5000
Instruction Manual

Error	Explanation	Action
The cut-off wheel does not cut through the sample.	Incorrect choice of cut-off wheel.	See Consumables section, Cut-off Wheels.
	Cut-off wheel worn.	Replace the cut-off wheel.
	The cut-off wheel gets caught in the workpiece.	Support the workpiece and clamp it on both sides of the cut-off wheel in such a way to allow the cut to stay open.
	Incorrect choice of Cutting Mode. AxioCut is intended for large workpieces.	See section on Operation, Cutting Mode.
The workpiece breaks when clamped.	The workpiece is brittle.	Place the workpiece between two polystyrene plates. NB! Always cut brittle workpieces very carefully.
The sample is corroded.	The sample is not resistant to water.	Use a neutral liquid as cooling fluid or cut without using cooling fluid at all. DO NOT USE AN INFLAMMABLE LIQUID
	The sample has been left in the cutting chamber for too long.	Leave the protection hood open, when you leave the machine.
	Insufficient additive for cooling fluid.	Add Struers cutting fluid additive and water to the recirculation tank in the correct concentration. Check with a refractometer. See Maintenance section.
<i>AutoStop</i> does not stop the cutting action.	The cross-section of the workpiece is too small or irregular to detect a change in load.	Use the <i>Stop position</i> function.
AxioCut cutting mode is not working.	AxioCut does not function when AutoCut is selected.	Go to the <i>Process options</i> menu and set AutoCut to Off .
Cut off wheel measurement doesn't work (only available on some variants)	There are some obstacles inbetween the sensors.	Remove the obstacles.
	The sensors are dirty and there is no communication between the sensors.	Clean the sensors.
	The diameter of the Cut of wheel is less then 300mm.	Replace the cut off wheel or confirm cutting even the cut of wheel is not detected.
The coordinates are not accepted	Coordinates go beyond the maximum X,Y,Z,R ranges	Adjust ranges to fit the upper limits. Use the simulation function to see the movement prior step by step

Error Messages

Error messages are divided into two classes, Messages and Errors. Follow instructions. Explanation is included below for relevant screens.

Messages

Messages are intended to inform the operator of the machine's progress and advise about minor operational errors.

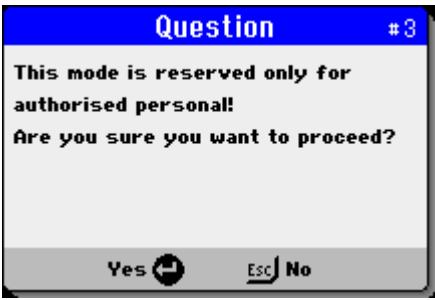
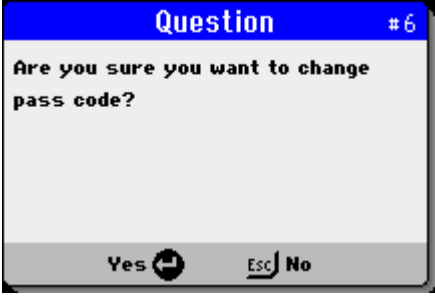
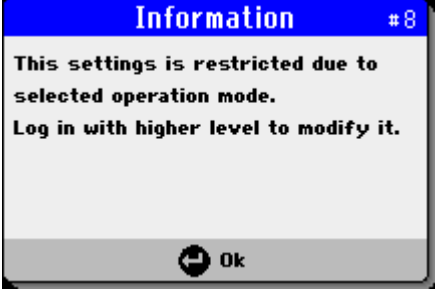

Errors

Errors must be rectified before cutting can be continued.

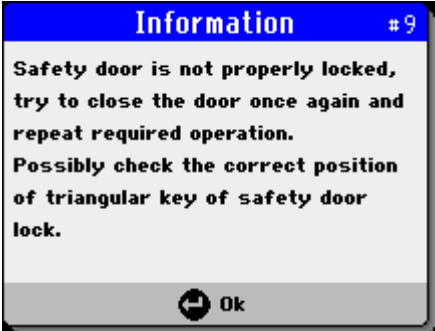
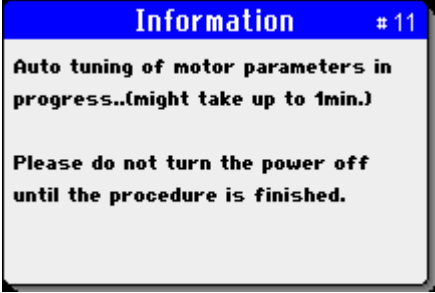
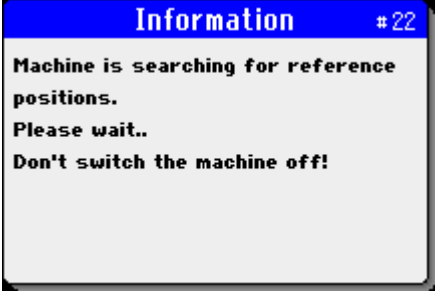
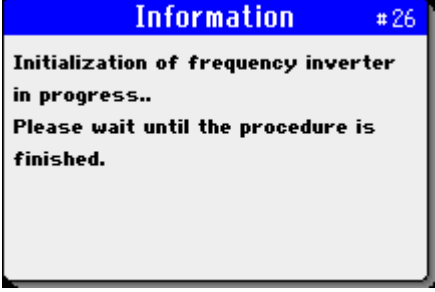

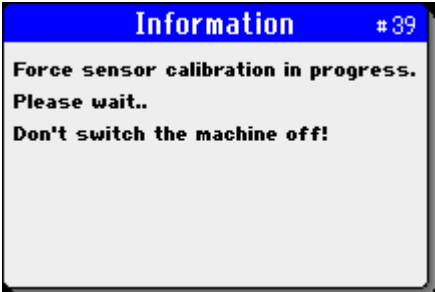
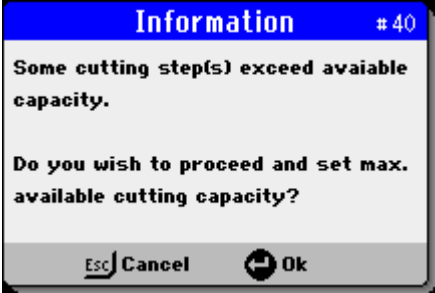
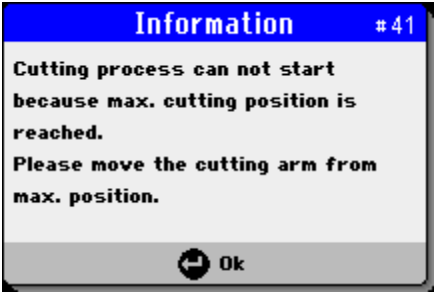
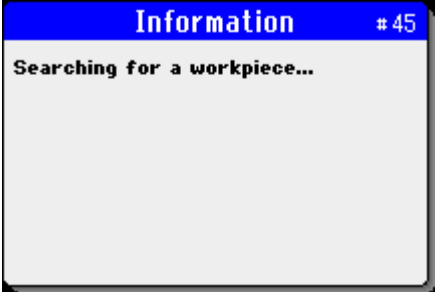
Message	Explanation	Action
	#3	<p>This Pop-up appears when F1 is pressed during switching-on.</p> <p>If yes - technician service menu will be activated.</p> <p>If no - machine will start by the "standard way".</p>
	#6	<p>New password is set by ENTER in PopUp Enter password.</p> <p>Yes – new password is saved</p> <p>No – now password is not accepted</p>
	#8	<p>nsufficient user rights for the operation</p> <p>Change operational mode in user options</p>

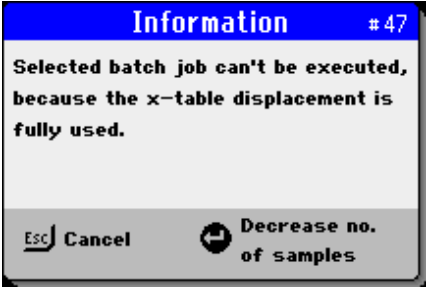
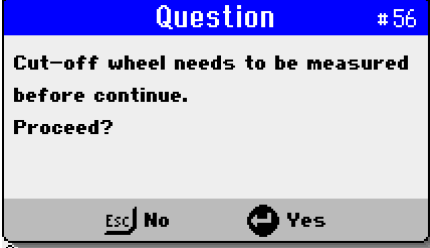
Message	Explanation	Action
	#9 Safety door not properly closed.	Try to re-open and close the safety door once again and repeat previous operation.
	#11 Autotuning procedure of frequency inverter and cutting motor is in progress.	Do not switch the machine off during this procedure.
	#22 Searching of reference position(s) are in progress.	Do not switch the machine off during this procedure.
	#26 The frequency inverter must initialize after each power on. During this initialization the message is shown to prevent user from other operation.	The message will disappear when initialization is completed.

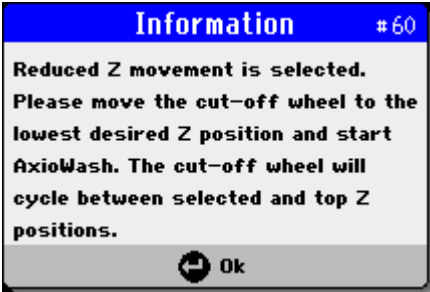

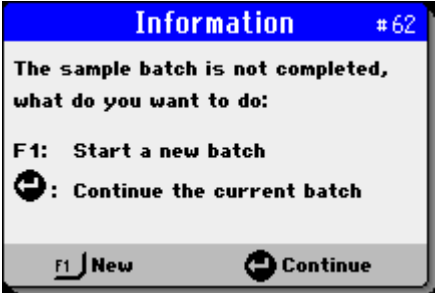
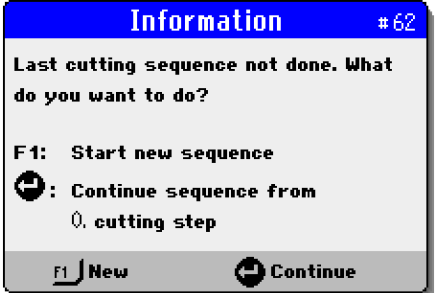
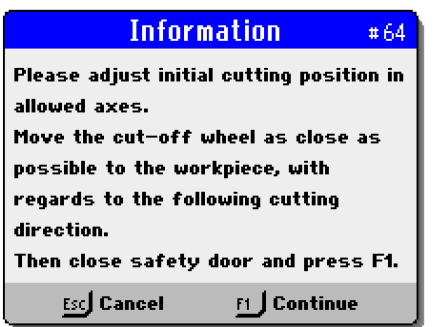
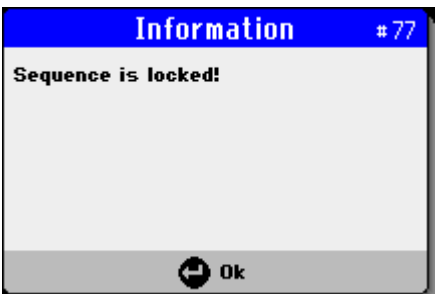
Message	Explanation	Action
 	<p>#38</p> <p>#39</p> <p>The messages appear every 50th start of the machine.</p>	<p>Close safety doors and press Enter to start calibration</p>
	<p>#40</p> <p>The selected cut size is not possible due to the current position of cut-off wheel.</p> <p>The cut length in at least of one cutting step exceeds max available movement range.</p>	<p>Press ENTER to set cut size to the maximum available or press Esc ↵ to return to the sequence.</p>
	<p>#41</p> <p>The cutting arm is very close to the end position, therefore the cutting process cannot be started.</p>	<p>Move the cutting arm from the end position and re-start the process.</p>
	<p>#45</p> <p>While in AutoCut, the cut-off wheel "searches" for a workpiece. During this phase, the cut-off wheel is lowered relatively fast (3mm/sec) and after first contact with sample (detected by force sensor or by increasing the motor current), the cut-off wheel is moved slightly back before the cutting process continues.</p>	<p>The message disappears when the cut-off wheel first contacts the workpiece.</p>

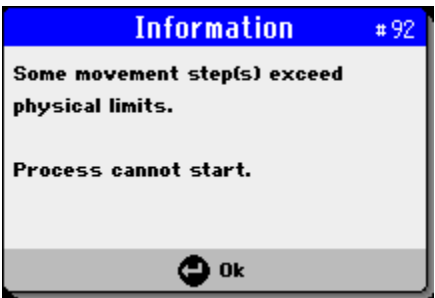
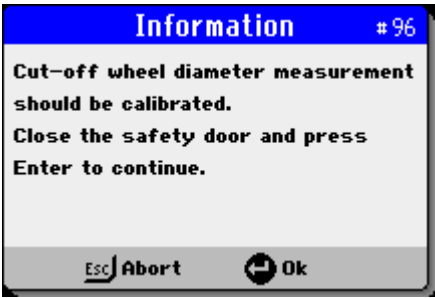
Message	Explanation	Action
	#47	Multicut is activated but the current position of the X-table is not enough to make all the cuts.
	#56	<p>The pop-up occurs in situation you try to edit the start point or movement step in the cutting sequence and the cut-off wheel diameter is invalid. The value of the cut-off wheel diameter is stored within a sequence.</p> <p>The diameter is invalid after reboot, spindle lock activation or after started cutting step.</p>
	#59	A safety door is open and joystick activated without using of two-hand button
	#60	“Reduced Z movement” for AxioWash is selected to notice the user what is necessary to setup the minimal Z position.

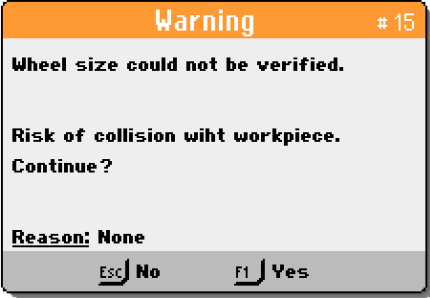
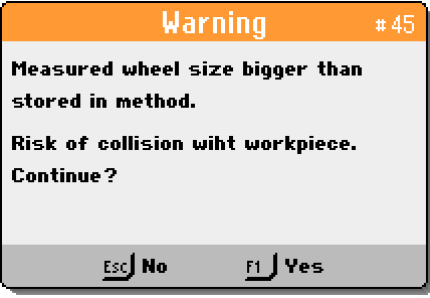
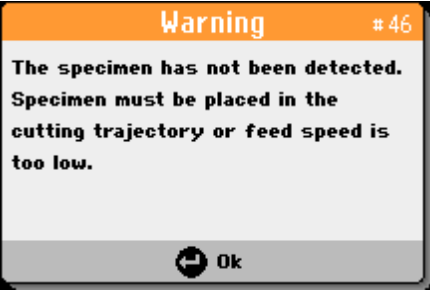

Message	Explanation	Action
	#62 The cutting sequence was stopped, followed by pressing the start button	Either continue from offered cut or start new sequence.
	#62 This pop-up occurs when the user starts stops a cutting sequence via stop button and presses start in the same sequence. It assumes that all cuts before current step were done and it offers to continue from 1 st unfinished cut.	Select Continue if you want to continue in stopped sequence. Select New if you want to forget made progress and start all over.
	#64 A cutting sequence is started via "Cut from" menu item, not start button.	Position all axes as desired and confirm operation. Only axes configured as adjustable in zero point setup are operable.
	#77 The parameter cannot be changed in locked mode	Unlock cutting sequence in sequence list and edit the setting

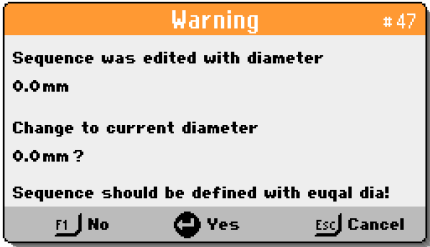
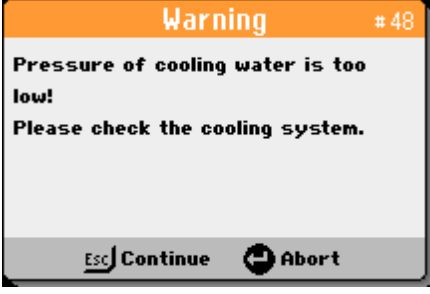

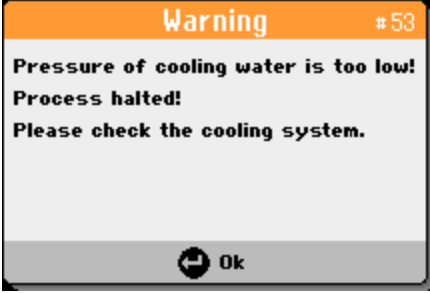
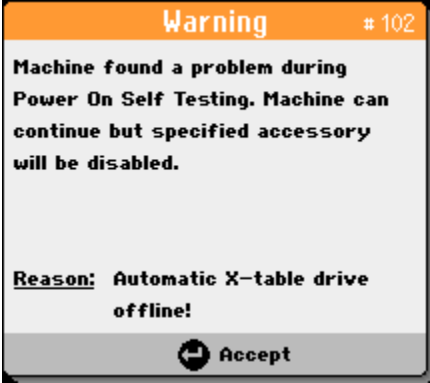
Message	Explanation	Action
 <p>Information #92 Some movement step(s) exceed physical limits. Process cannot start. Ok</p>	<p>#92</p> <p>Pop-up displayed when a sequence is started without sufficient space to make all requested moves.</p> <p>If any of axis is configured as adjustable the evaluation of sequence feasibility is based on its current position.</p>	<p>Confirm the dialog and edit/reposition axes to be able to run the sequence.</p>
 <p>Information #96 Cut-off wheel diameter measurement should be calibrated. Close the safety door and press Enter to continue. Esc Abort Ok</p>	<p>#96</p> <p>Pop-up occurs after reference searching or after 20 startups of machine.</p> <p>It requires to calibrate cut-off wheel measurement system.</p>	<p>Perform the calibration.</p> <p>In case this is not possible, it can be postponed to next startup and the measurement will work with current calibration values</p>
 <p>Information #115 It is now time to service Magnutom. Please call for a service visit.</p> <p>Total operating time: 1000 h Time since last service: 500 h Time until next service: 2 h Memory module installed Ok</p>	<p>#115</p> <p>Service period expires. It is time to check the Magnutom</p>	<p>Please contact a service technician</p>



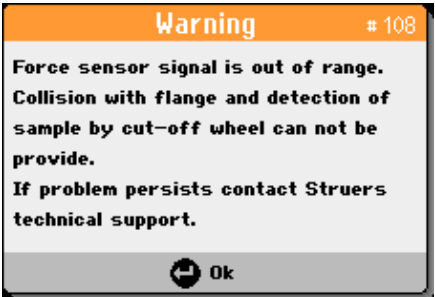

Message	Explanation	Action
 <p>Warning # 15</p> <p>Wheel size could not be verified.</p> <p>Risk of collision with workpiece.</p> <p>Continue?</p> <p>Reason: None</p> <p>Esc No F1 Yes</p>	<p>#15</p> <p>Cutting sequence remembers size of a cut-off wheel it was defined with to detect potential collisions between bigger cut-off wheels and workpieces.</p> <p>The message is displayed in case the size of wheel could not be verified before sequence starts.</p>	<p>Continue in sequence if you are sure collision might not occur. Otherwise abort operation.</p> <p>To redefine currently stored wheel size try to edit start point or any movement step defined in sequence.</p>
 <p>Warning # 45</p> <p>Measured wheel size bigger than stored in method.</p> <p>Risk of collision with workpiece.</p> <p>Continue?</p> <p>Esc No F1 Yes</p>	<p>#45</p> <p>A cutting sequence is always defined with a cut-off wheel of a certain diameter. When the sequence starts the size of wheel is verified.</p> <p>If diameter of currently installed wheel is at least 3mm bigger than stored diameter, the pop-up occurs.</p>	<p>Continue in sequence if you are sure collision might not occur or you don't care. Otherwise abort the sequence.</p> <p>To redefine currently stored wheel size try to edit start point or any movement step defined in sequence.</p>
 <p>Warning # 46</p> <p>The specimen has not been detected. Specimen must be placed in the cutting trajectory or feed speed is too low.</p> <p>Ok</p>	<p>#46</p> <p>AutoCut is activated and the workpiece has not been detected during the cutting trajectory.</p> <p>Detection of workpiece is based on a change in the cutting motor current.</p> <p>The idle cutting motor current must increase by a set value upon contact with the workpiece. At low feed speeds, the difference between idle current and cutting current is very low so the workpiece is not detected.</p>	<p>Increase the feed speed and re-start the cutting process.</p>

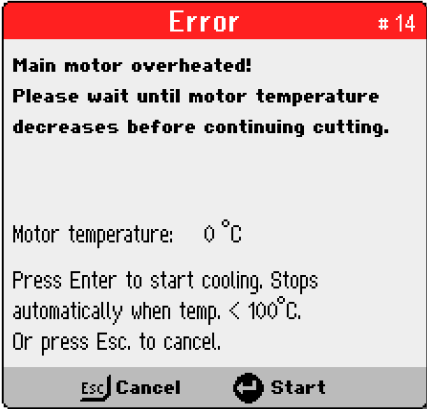
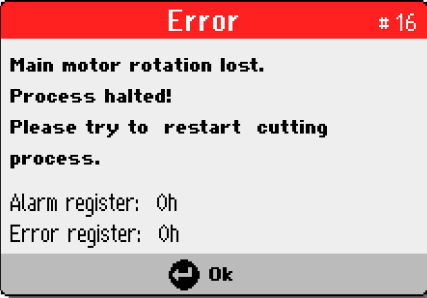
Message	Explanation	Action
	<p>#47</p> <p>A cutting sequence is always defined with a cut-off wheel of a certain diameter. If you edit the sequence with different wheel than it was originally defined with, the following pop-up appears.</p> <p>Typical situation will be when you returning to older cutting sequence.</p>	<p>If you want just to adjust some value in sequence without major changes select No. This will keep currently stored diameter.</p> <p>If you are performing bigger changes and you plan to change whole geometry select Yes. This will change diameter to currently used one.</p> <p>Select Cancel to leave the operation.</p>
	<p>#48</p> <p>Water flow is too low at the beginning of a cutting process.</p>	<p>Press ENTER to abort the cutting process. Then check the cooling system.</p> <p>or</p> <p>The water sensor may be malfunctioning. Check if there is sufficient water flow, press Esc  to continue with cutting process.</p> <p>If error remains, contact a Struers Service Technician.</p>
	<p>#53</p> <p>Water flow is too low at the beginning of a cutting process.</p>	<p>Press ENTER to abort the cutting process. Then check the cooling system.</p> <p>If error remains, contact a Struers Service Technician.</p>
	<p>#102</p>	<p>Re-start.</p> <p>If error remains, contact a Struers Service Technician.</p>

Magnutom 5000
Instruction Manual

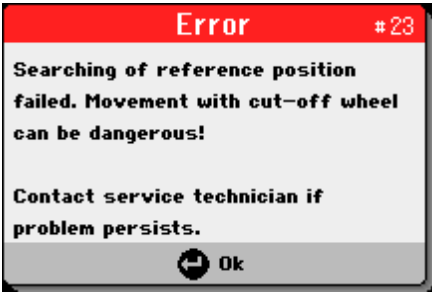
Message		Explanation	Action
 <p>Warning # 108</p> <p>Force sensor signal is out of range. Collision with flange and detection of sample by cut-off wheel can not be provide. If problem persists contact Struers technical support.</p> <p>Ok</p>	#108	<p>Force sensor is not detected.</p> <p>Magnutom will operate without this sensor but some features, e.g. detection of workpiece will not function.</p>	<p>Re-start.</p> <p>If error remains, contact a Struers Service Technician.</p>
 <p>Warning # 111</p> <p>Force sensor is disabled!</p> <p>Detection of specimen and limitation of max. cutting force can not be provide.</p> <p>Ok</p>	#111	<p>The force sensor is disabled in the service menu.</p> <p>Magnutom will operate without this sensor but some features, e.g. detection of workpiece will not function.</p>	<p>Contact a Struers service technician to re-enable the force sensor.</p>

Error	Explanation	Action	
 <p>Error # 14</p> <p>Main motor overheated! Please wait until motor temperature decreases before continuing cutting.</p> <p>Motor temperature: 0 °C</p> <p>Press Enter to start cooling. Stops automatically when temp. < 100 °C. Or press Esc. to cancel.</p> <p>Esc Cancel Start</p>	#14	<p>Motor temperature is > 150°C during start of process or</p> <p>Motor temperature is > 170°C during cutting process.</p>	<p>Press ENTER and wait until the motor has cooled.</p>
 <p>Error # 16</p> <p>Main motor rotation lost. Process halted! Please try to restart cutting process.</p> <p>Alarm register: 0h Error register: 0h</p> <p>Ok</p>	#16	<p>Cutting motor has stopped rotating.</p> <p>A fluctuation may have occurred in the mains power supply.</p>	<p>Check the mains power supply then Re-start.</p> <p>If error remains, contact a Struers Service Technician.</p>
 <p>Error # 17</p> <p>Main motor overloaded! Process halted! Please decrease feed speed before continuing.</p> <p>Ok</p>	#17	<p>Magnutoms OptiFeed feature automatically reduces feed speed if the load on the motor exceeds a set value.</p> <p>However, under some circumstances (e.g. initial feed speed too high or joystick movement activated during cutting) the Optifeed cannot decrease the feed speed fast enough and the motor current reaches a set limit.</p>	<p>Reduce the set feed speed before re-starting the cutting process.</p>

Error	Explanation	Action
	<p>#23</p> <p>A problem has occurred during search for reference positions and the procedure has been interrupted.</p> <p>Attention!:</p> <p>Speed of cutting arm is reduced to enable some movement with the joystick but a cutting process cannot be started.</p> <p>Searching of reference position is required again after next switching on.</p>	<p>Press ENTER to acknowledge this message.</p>
	<p>#24</p> <p>General Y-servo motor error detected during movement.</p>	<p>Press ENTER to clear this error inside servo motor to re-enable the movement.</p> <p>Re-start.</p> <p>If error remains, contact a Struers Service Technician.</p> <p>Please make a note of the <i>Reason code</i> and <i>Error status register</i> displayed on Magnutom.</p>
	<p>#25</p> <p>General Z-servo motor error detected during movement.</p>	<p>Press ENTER to clear this error inside servo motor to re-enable the movement.</p> <p>Re-start.</p> <p>If error remains, contact a Struers Service Technician.</p> <p>Please make a note of the <i>Reason code</i> and <i>Error status register</i> displayed on Magnutom.</p>
	<p>#35</p> <p>An over current is detected during movement of the X-table. Usually due to an obstacle in the X-tables trajectory (e.g. sample is squeezed or the X-table is blocked).</p>	<p>Remove any obstacles then press ENTER to clear the error.</p>

Magnutom 5000
Instruction Manual

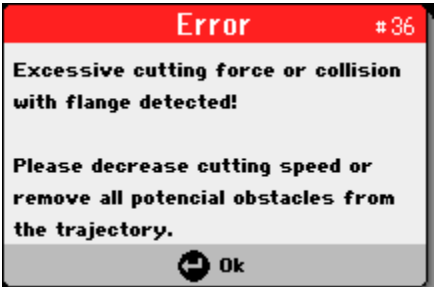
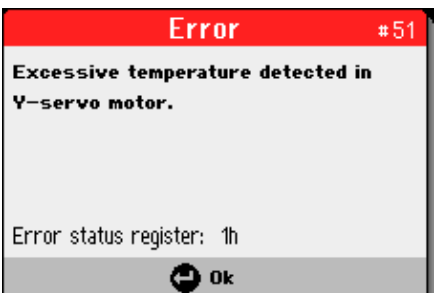
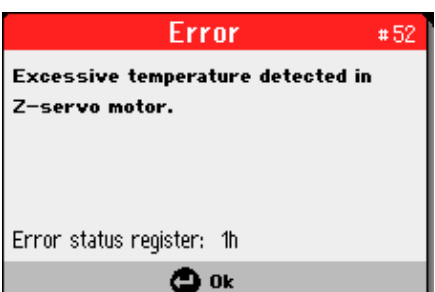
Error	Explanation	Action	
	<p>#36</p>	<p>Excessive force is detected during a cutting process.</p> <p>This can happen if flange or cut-off wheel guard collides with a cutting sample.</p>	<p>Remove any obstacles from cutting direction then press ENTER to clear the error.</p>
	<p>#51</p>	<p>An over temperature (> 73°C) is detected during movement with Y or Z servo motor.</p>	<p>Press ENTER to clear this error inside servo motor to re-enable the movement.</p>
	<p>#52</p>		<p>Turn Magnutom off and allow the servo motor to cool down.</p>

6. Service

Service Information

Struers recommends that a regular service check be carried out yearly (or after every 1,500 hours of use, if this is sooner).

Struers offers a range of comprehensive maintenance plans to suit the requirements of our customers. This range of services is called **ServiceGuard**.

The maintenance plans include equipment inspection, replacement of wear parts, adjustments/calibration for optimal operation, and a final functional test.

Information on total operation time and servicing of the machine is displayed on the screen at start-up:

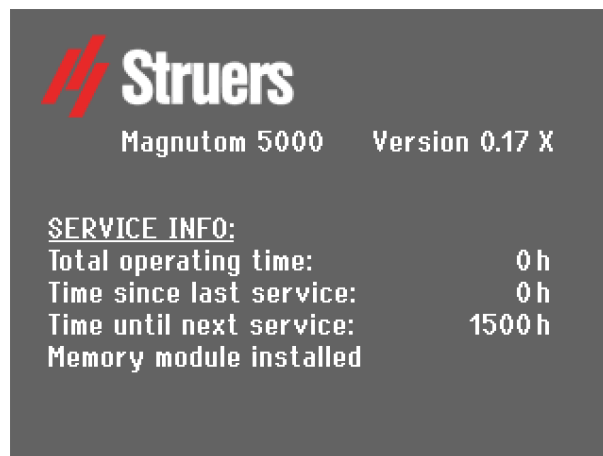

A pop-up message will alert the user that the recommended service interval has been exceeded.

Lubricating Moving Parts

Part of Struers ServiceGuard

Magnutom is equipped with an automatic lubrication system for the movement mechanisms.

Magnutom 5000
Instruction Manual

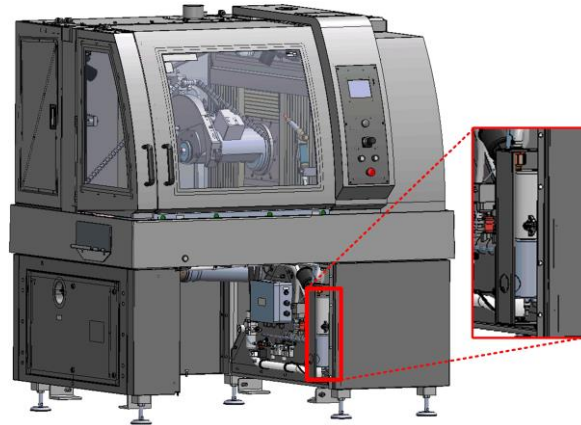

The grease cartridge will need to be replaced after 1,500 hours of service.

Replacing the grease cartridge is part of the Struers **ServiceGuard** program.

7. Legal and Regulatory

FCC Notice

This equipment has been tested and found to comply with the limits for a Class A digital device, pursuant to Part 15 of the FCC Rules. These limits are designed to provide reasonable protection against harmful interference when the equipment is operated in a commercial environment. This equipment generates, uses, and can radiate radio frequency energy and, if not installed and used in accordance with the Instruction Manual, may cause harmful interference to radio communications. Operation of this equipment in a residential area is likely to cause harmful interference in which case the user will be required to correct the interference at his own expense.

Pursuant to Part 15.21 of the FCC Rules, any changes or modifications to this product not expressly approved by Struers ApS could cause harmful radio interference and void the user's authority to operate the equipment.

EN ISO 16089:2015

The figures quoted are emission levels and are not necessarily safe working levels. Whilst there is a correlation between the emission and exposure levels, this cannot be used reliably to determine whether or not further precautions are required.

Factors that influence the actual level of exposure of the workforce include the characteristics of the workroom and the other sources of noise, i.e. the number of machines and other adjacent processes and the length of time for which an operator is exposed to the noise.

Also, the permissible exposure level can vary from country to country. This information, however, will enable the user of the machine to make a better evaluation of the hazard and risk.

IEC 61000-3-12

This equipment complies with IEC 61000-3-12 provided that the short-circuit power S_{sc} is greater than or equal to 5,9 MW at the interface point between the user's supply and the public system. It is the responsibility of the installer or user of the equipment to ensure, by consultation with the distribution network operator if necessary, that the equipment is connected only to a supply with a short-circuit power S_{sc} greater than or equal to 5,9 MW.

EN ISO 13849-1:2015

Safety parts of the control system have been evaluated according to EN 13849-1:2015 and EN 60204-1:2006.

8. Spare Parts and Diagrams

Safety Related Parts of the Control System (SRP/CS)



NOTE:

Replacement of Safety critical components can only be performed by a Struers engineer or a qualified technician (electromechanical, electronic, mechanical, pneumatic, etc.).

Safety critical components may only be replaced by components with at least the same safety level.

Contact Struers Service for information.

Magnutom-5000 YZ

Magnutom-5000 YZ	Order number
Cut-off wheel guard	16580508
Front PETG safety glass	16140572
Side PETG safety glass	16140556
Y,Z axis proximity sensor disk	16140981
Solenoid interlock AZM 161	2SS00120
Solenoid interlock actuator AZM 161	2SS01616
Magnetic sensor BNS120	2SS00130
Magnetic sensor actuator BP-10	2SS00131
Y,Z axis proximity sensors E2B	2HQ00030
Safety controller CPU module	2KS10030
Safety controller PSU module	2KS10031
Safety controller XTIO module	2KS10032
Speed monitor MOC3SA module	2KS10033
Frequency inverter V1000	2PU12050
STO module contactor J7KNA	2KM70900
Axis motor contactor J7KNG	2KM71411
Auxiliary relay PT	2KL10030
Hold-to-run button	2SA00400 2SA41603 2SB10072
Emergency stop button	2SA10400 2SA41603 2SB10071
Cut-off wheel valve VT307	2YM10030
Axiowash valve D132	2YM10132

Magnutom-5000 XYZ

Magnutom-5000	Order number
Cut-off wheel guard	16580508
Front PETG safety glass	16140572
Side PETG safety glass	16140556
Y,Z axis proximity sensor disk	16140981
X proximity sensor disk	16580185
Rz proximity sensor disk	16580322
Solenoid interlock AZM 161	2SS00120
Solenoid interlock actuator AZM 161	2SS01616
Magnetic sensor BNS120	2SS00130
Magnetic sensor actuator BP-10	2SS00131
Y,Z axis proximity sensors E2B	2HQ00030
X,Rz axis proximity sensors E2B – shielded	2HQ00031
Safety controller CPU module	2KS10030
Safety controller PSU module	2KS10031
Safety controller XTIO module	2KS10032
Speed monitor MOC3SA module	2KS10033
Frequency inverter V1000	2PU12050
STO module contactor J7KNA	2KM70900
Axis motor contactor J7KNG	2KM71411
Auxiliary relay PT	2KL10030
Hold-to-run button	2SA00400 2SA41603 2SB10072
Emergency stop button	2SA10400 2SA41603 2SB10071
Cut-off wheel valve VT307	2YM10030
Axiowash valve D132	2YM10132

Magnutom-5000 XYZR

Magnutom-5000 XYZR	Order number
Cut-off wheel guard	16580508
Front PETG safety glass	16140572
Side PETG safety glass	16140556
Y,Z axis proximity sensor disk	16140981
X proximity sensor disk	16580185
Rz proximity sensor disk	16580322
Solenoid interlock AZM 161	2SS00120
Solenoid interlock actuator AZM 161	2SS01616
Magnetic sensor BNS120	2SS00130
Magnetic sensor actuator BP-10	2SS00131
Y,Z axis proximity sensors E2B	2HQ00030
X,Rz axis proximity sensors E2B – shielded	2HQ00031
Safety controller CPU module	2KS10030
Safety controller PSU module	2KS10031
Safety controller XTIO module	2KS10032
Speed monitor MOC3SA module	2KS10033
Frequency inverter V1000	2PU12050
STO module contactor J7KNA	2KM70900
Axis motor contactor J7KNG	2KM71411
Auxiliary relay PT	2KL10030
Hold-to-run button	2SA00400 2SA41603 2SB10072
Emergency stop button	2SA10400 2SA41603 2SB10071
Cut-off wheel valve VT307	2YM10030
Axiowash valve D132	2YM10132



WARNING

The PETG screen must be replaced after a lifetime of 5 years. Other Safety critical components are to be replaced as required, depending on the wear on the machine, but must be replaced at after a maximum lifetime of 20 years[1].

Diagrams

Magnutom-5000 Block diagram.....	16583050
Magnutom-5000 Water diagram.....	16581000
Magnutom-5000 Air diagram.....	16581001

See the following pages.

Circuit Diagram. Please refer to the main marking plate on the machine.

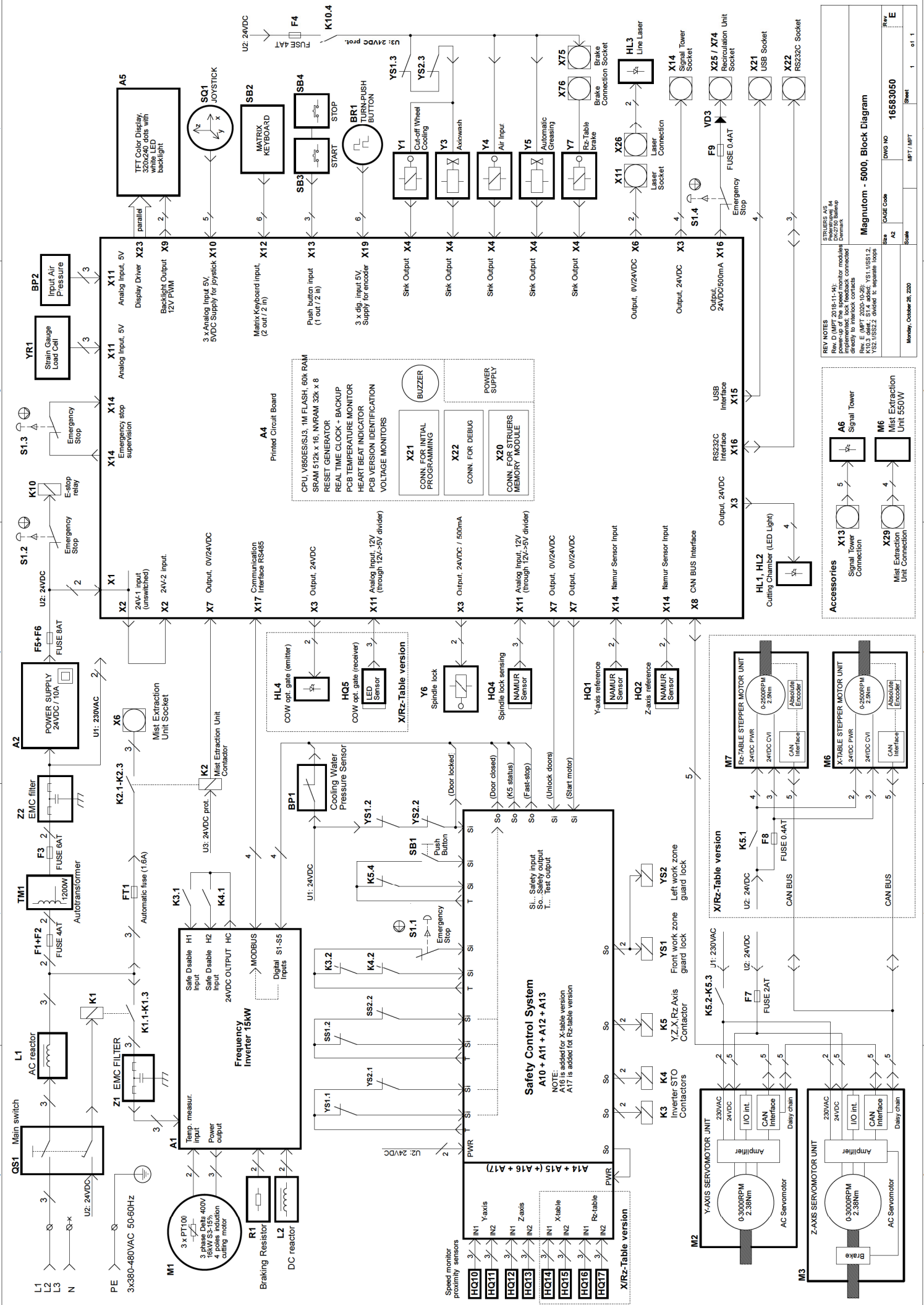

REV NOTES
 Rev. D (MPT 2018-11-14):
 power-up of the speed monitor module
 Rev. E (MPT 2020-10-20):
 K10.3 added; S1.4 added; YS1.1, RS1.2,
 YS2.1, RS2.2 removed to separate loops

STRUBERS AS
 Rørdalsvej 14
 8260 Ålborg
 Denmark

Magnatrom - 5000, Block Diagram

Rev. No. **16583050**
 DWG NO. **16583050**
 Scale **1:1**
 MPT / MFT **1** of **1**

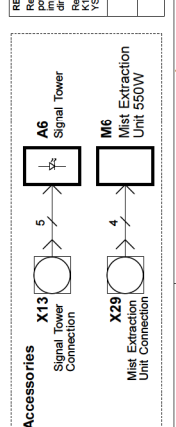

Safety Control System
 A10 + A11 + A12 + A13
 NOTE:
 A16 is added for X-table version
 A17 is added for Rz-table version

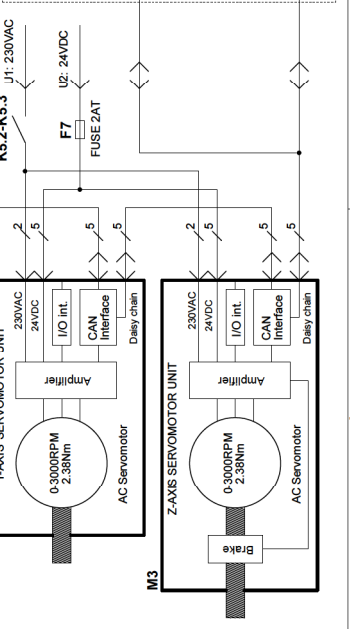
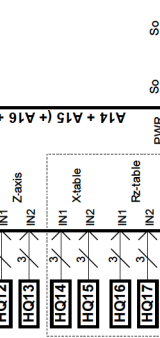

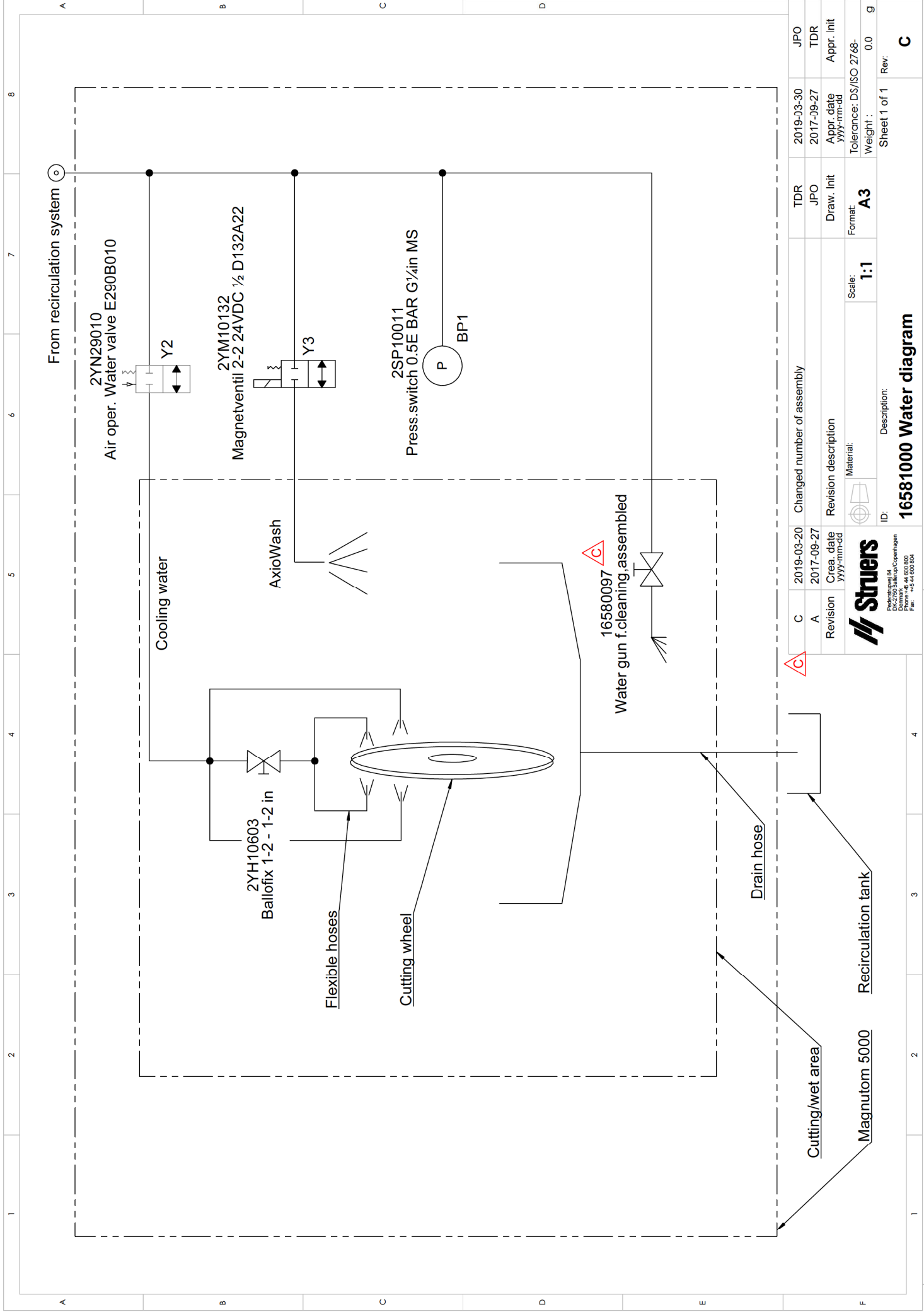

C	2019-03-20	Changed number of assembly	TDR	2019-03-30	JPO
A	2017-09-27	Revision description	JPO	2017-09-27	TDR
		Material:	Draw. Init	Appr. date	Appr. Init
		1:1	Format:	yyy-mm-dd	yyy-mm-dd
			A3	Tolerance: DS/ISO 2768-	0.0
				Weight :	0.0
				Sheet 1 of 1	Rev: C

Struers
 Pøstboksvej 84
 DK-2605 Solbjerg
 Denmark
 Phone: +45 6601 8000
 Fax: +45 6601 8004

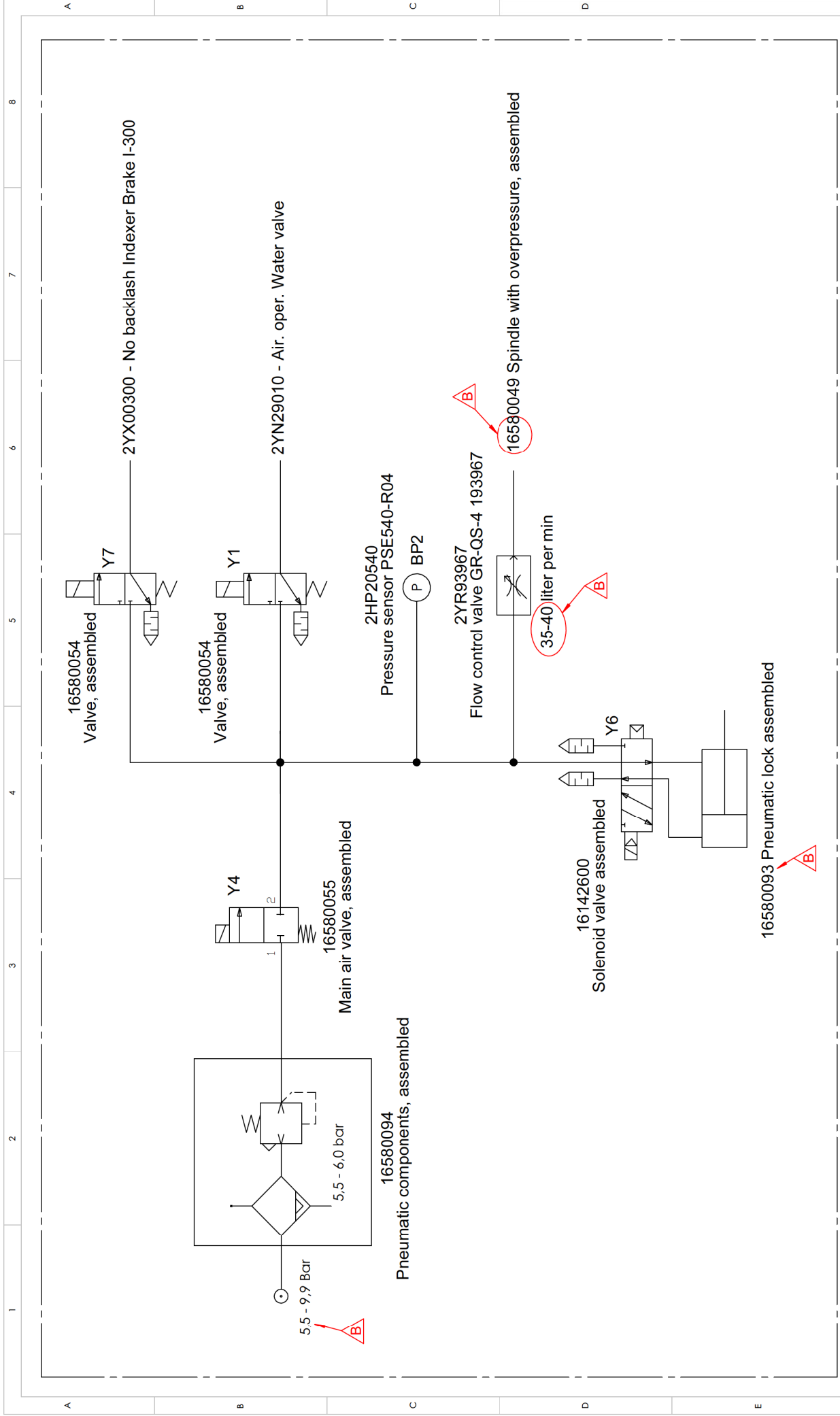

16581000 Water diagram



B		2019-03-20	changed values, also assembly numbers		TDR	2019-03-30	JPO
A		2017-06-22			JPO	2017-06-22	JIF
Revision	Crea. date	yyy-mm-dd	Revision description		Draw. Init	Appr. date	Appr. Init
	yyy-mm-dd		Material:		Format:	Tolerance: DS/ISO 2768-	
			Scale: 1:1		A3	Weight :	g
			ID:		Description:		
					16581001 AIR DIAGRAM Magnutom-5000		
					Sheet 1 of 1		
					Rev: B		



9. Technical Data

Subject		Specification
Cutting capacity (max)		Ø 190 mm / 7.4"
		190 x 254 mm / 7.4 x 10" and 184 x 400 mm / 7.2 x 15.7"
		114 x 618 mm / 4.5 x 24.3" (values valid for YZ and XYZ) 114 x 533 mm / 4.5 x 21"
PHYSICAL SPECIFICATIONS		
Cutting motor	Cutting power (S1)	11 kW / 14.7 HP
	Cutting power (S3)	16 kW / 21.5 HP
Cut-off wheel for	Diameter x Thickness x Centre-hole	508 x 3.5 x 32 mm / 20 x 0.13 x 1.26"
	Rotational speed (at rated load)	1,000 – 2,400 rpm
Positioning & Feed	Positioning range (of cut-off wheel)	Y= 395 mm / 15.55", Z= 214 mm / 8.43"
	Max. positioning speed	Y= 70 mm/sec / 2.75"/s, Z/X/R = 50 mm/sec / 1.97"/s
	Feed Speed range	0.1 – 10 mm/s / 0.002 – 0.2"/s
	(adjustable in steps of)	(0.1 mm/s / 0.002"/s)
	Cutting force	0-1400 N / 10-315 lbf
Cutting table area		
- Fixed cutting table (YZ)	Width x Depth	751x781 mm / 29.57 x 30.7"
- X-table (XYZ)	Width x Depth	524x781 mm / 20.63 x 30.7"
- Rotary table (XYZR)	Diameter	533 mm / 21.0"
Automatic movements		
- X-table stroke range (XYZ)		370 mm / 14.6"
- R-table (XYZR)		+/- 180 degr.
T-slots, bi-directional		12 mm / 0.48"
Dimensions and weight	Width	1,758 mm / 5' 9"
	Depth	1,463 mm / 4' 9"
	Height	1,882 mm / 6' 2"
	Weight	2,650 kg / 5,840 lbs
Cutting chamber	Width	1,000 mm / 3' 3"
	Depth	1,206 mm / 3' 11"
	Height	918 mm / 3' 0"
Surrounding temperature (storage/transport)		5 - 40 °C / 40 - 105 °F (0 – 60 °C / 32 – 140 °F)
Humidity (storage/transport)		10 - 85 % RH, non-condensing (0 – 90 % RH, non-condensing)
Laser		Class 2M

Magnutom 5000
Instruction Manual

Subject						Specification
ENVIRONMENT						
Noise level	Approx. 61 dB(A) running idle, at a distance of 1.0 m / 39.4" from the machine.					
Compressed air	5.5 – 9.9 bar pressure (Class-3, as specified in ISO 8573-1), min 40l/min					
ELECTRICAL DATA						
Specification						
	Cutting Power at constant duty, S1	Cutting Power at intermittent duty, S3 15%	Max. Power	Nom. Load	Max. Load	
Voltage / frequency:						
3 x 380-480 V / 50-60 Hz	11 kW / 14.7 HP	16 kW / 21.5 HP	18 kW / 24.1 HP	34 A	48 A	



NOTE:

In cases of discrepancy between metric and imperial dimensions, use the metric values.

Mains Cable Specification

Wire gauge (Cooper only)	EU: Min. 10mm ² North America: Min. AWG8
Cable diameter	Max. 28 mm

External Short Circuit Protection

Machine must be protected with external fuses.

Recommended fuse size: 63 A

Max. allowable fuse size: 80 A

Residual Current Circuit Breaker

Electrical Installations with RCCB

The equipment must be protected by RCCB type B time delayed, 30 mA (or better).

Electrical Installations without RCCB

The equipment must be protected by an insulation transformer (double-wound transformer).



NOTE:

Local standards may overrule the recommendations for the main supply cable. If necessary, please contact a **qualified electrician** to verify which option is suitable for the local installation setup.

Cutting Capacity

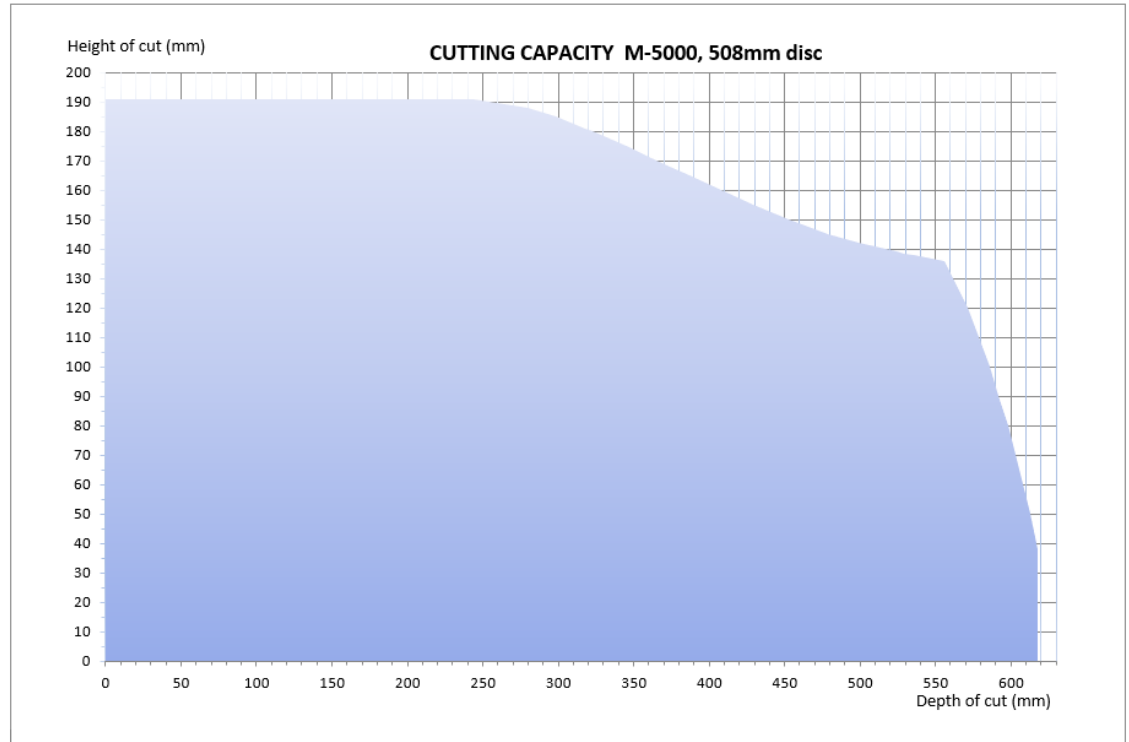

The graph shows the projected cutting capacity under the following conditions:

- A new cut-off wheel
- The workpiece is laid directly on the cutting table
- Vertical clamping is used
- Using ZY or AxioCut cutting mode

The actual cutting capacity depends on the sample material, cut-off wheel and clamping technique.

Quick Reference

Clamping the Workpiece

- Place the workpiece between the clamp and the back stop on the right hand cutting table.
- Push the clamp towards the workpiece and lock the quick-clamping device with the locking handle.

Starting the Cutting

- Position the cut-off wheel.
- Close the protection hood.
- Press START \blacklozenge . The cut-off wheel starts rotating and the cooling water starts running.

Stopping the Cutting

Automatic

- Set a Cut length or set to AutoStop in the *Edit method* menu.

Manual Stop

- Press STOP \odot and the cutting process stops. The cut-off wheel stops rotating and the cooling water stops.

Setting the Cutting Parameters

- In the Cutting Display, set each of the cutting parameters using the TURN/PUSH knob.

Changing the Cut-off Wheel

- Remove the nut with a fork spanner.
- Remove the flange and the cut-off wheel.
- Mount the new cut-off wheel.
- Mount the flange and nut. Tighten carefully and close the guard.

Cleaning the Cutting Chamber

AxioWash

- Press the AxioWash key to clean the cutting chamber.

Manual

- Point the flushing gun towards the bottom of the cutting chamber.
- Turn on the water by pressing the Flush key on the Control Panel.
- Clean the cutting chamber thoroughly.
- Turn off the water by pressing the Flush key again. Return the flushing gun to its holder.

Magnutom-5000, Pre-Installation Checklist

Read the Installation instructions in the Instruction Manual
before
installing the machine.

Installation Requirements

- Crane and 2 lifting straps* OR forklift truck (lifting capacity > 3,000 kg / 6,700 lbs)
- Wrench/ bit: 10 mm Hexagonal ●
- Electrical cable (4-lead or 5-lead) with three phases and one earth connection (see table on page [138](#) for details).
- External Short Circuit Protection (see table on page [139](#) for details)
- Residual Current Circuit Breaker (see table on page [139](#) for details)
- 8 mm hose for Compressed Air
Required Accessories and Consumables (ordered separately)
- Cut-off wheels and Clamping Tools.
(Please refer to the [Magnutom Brochure](#) and the [Struers Cut-off Wheels brochure](#) for details of the range available).
- Recirculation cooling unit
- Additive for recirculation cooling unit
- Exhaust system: 700m³/h / 24720 ft³/h at 0mm/0" water gauge

* Straps and crane must be certified to lift at least twice the weight of the machine.

Crating specifications

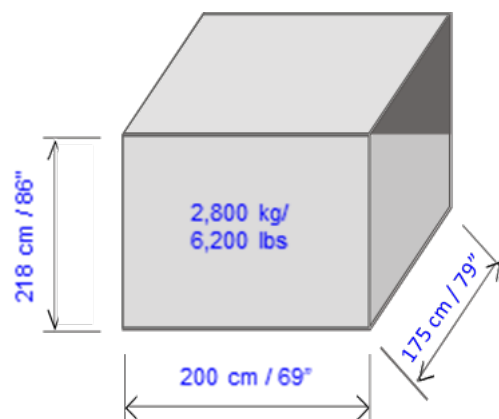

Location

The machine is designed to be placed on the floor. Make sure that the floor of the working area and the transportation corridor is designed to carry Magnutom's weight.

Dimensions

Width (front door open)	180 cm / 70.7" 262 cm / 103"
Depth (including control panel)	145 cm / 57.1"
Height with mist extractor (option) with signal beacon (option)	194 cm / 76.4" 225 cm / 88.5" 230 cm / 90.6"

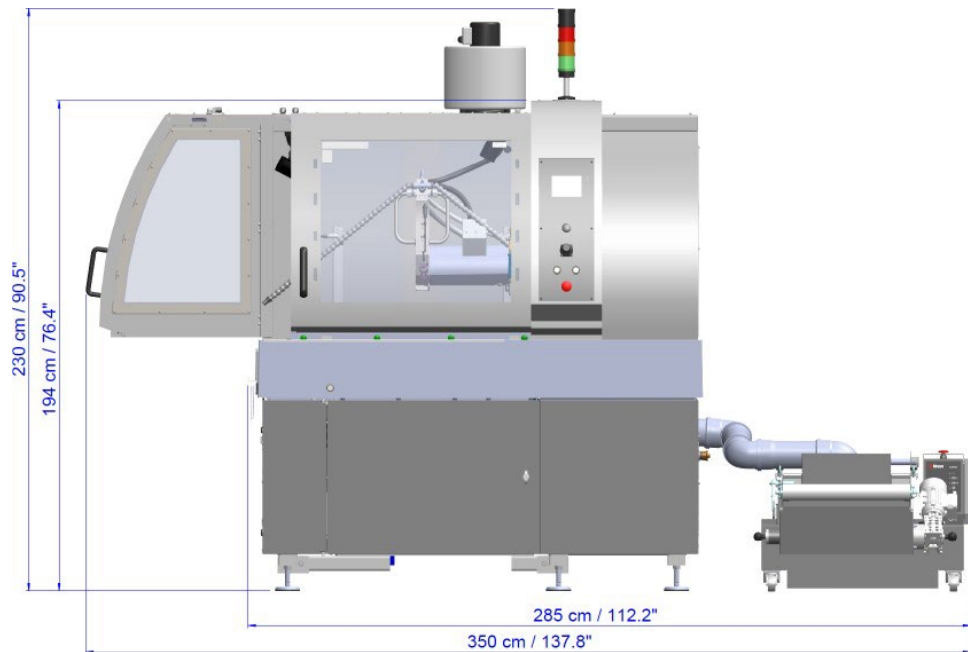

Magnutom-5000, Pre-Installation Checklist

Right and front



Centre of gravity

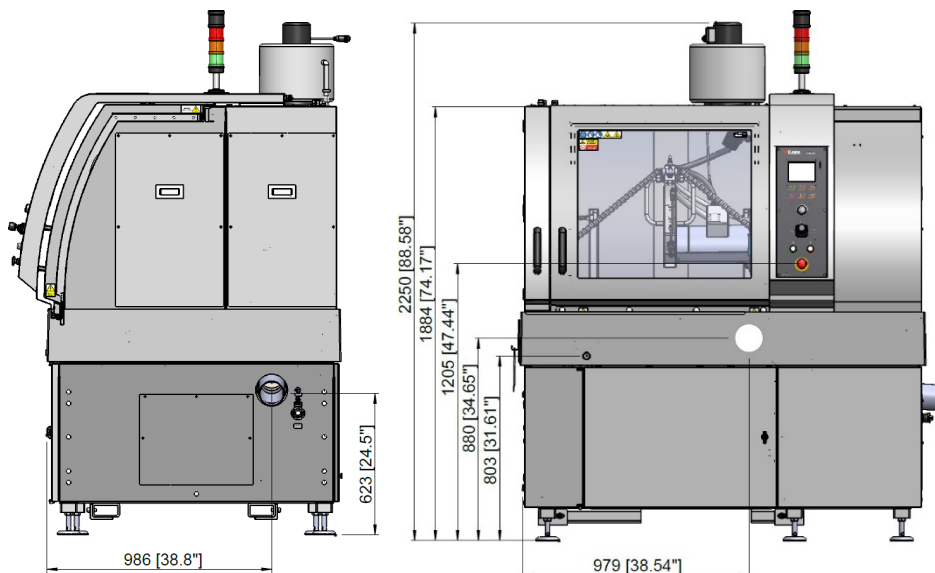

Left and back

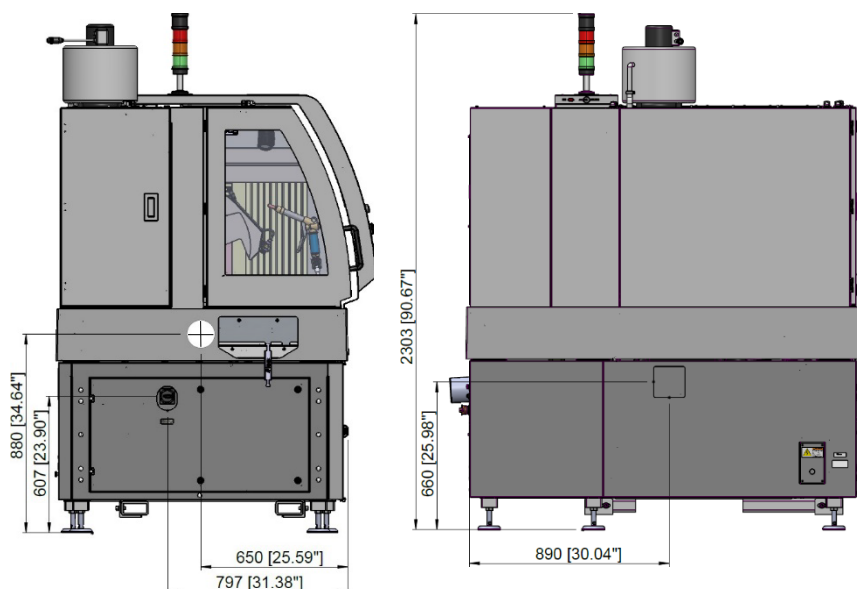

Distance from floor to:

Power connection	30 cm / 11.8"
Water inlet	53 cm / 21"
Water outlet	Under the machine, with opening at the right hand side and rear of the machine
Main switch	61 cm / 24"
Emergency Stop (at Front)	121 cm / 48"
Hold-to-run button (for positioning of Cut-off wheel)	80 cm / 31.5"

Recommended space

<i>Front</i>	Recommended space at the front: 100 cm / 40".
<i>Rear</i>	Recommended space behind the machine: 100 cm / 40".
<i>Sides</i>	Recommended space at the left: 100 cm / 40" – to open the side door fully Recommended space at the right: 100 cm / 40" – for Recirculation Cooling Unit (e.g .Coolimat-2000)



HINT:

If heavy workpieces are to be moved using a forklift truck, allow extra space on the left and from the front for full access to the cutting table.

HINT:

Future maintenance and service require access to the back of the machine.

Unpacking

- Carefully open and remove the sides and the top of the packing crate.
- Remove the transport brackets securing the machine to the pallet.
- After unpacking set the legs high to 110 mm and secure their position with nuts.

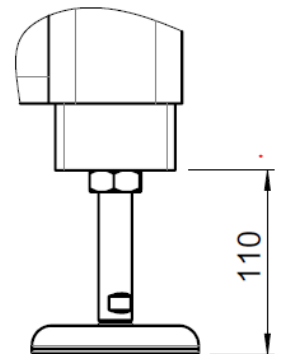

Lifting

Weight:
2,650 kg / 5,850 lbs

A forklift truck or crane is required to lift Magnutom off the shipment pallet.

Forklift

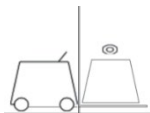

- Special requirements for the fork lift
- Capable of lifting 3,000 kg / 6,700 lbs
- Adjustable forks min. 2 m / 6' 7" long (forks need to be able to go all the way through the pallet and the entire length of the machine)

Adjust the position of the fork following the pictures bellow.

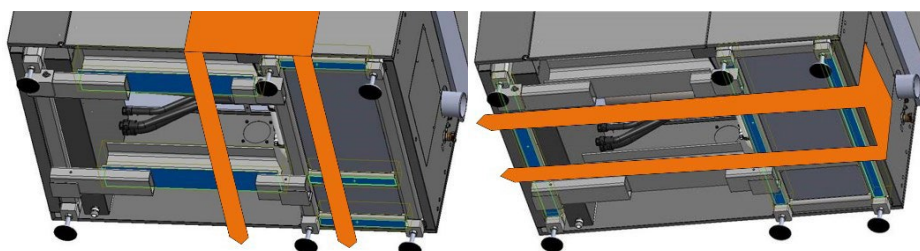

Lift from front (recommended).

Lift from right-side.



Centre of gravity.

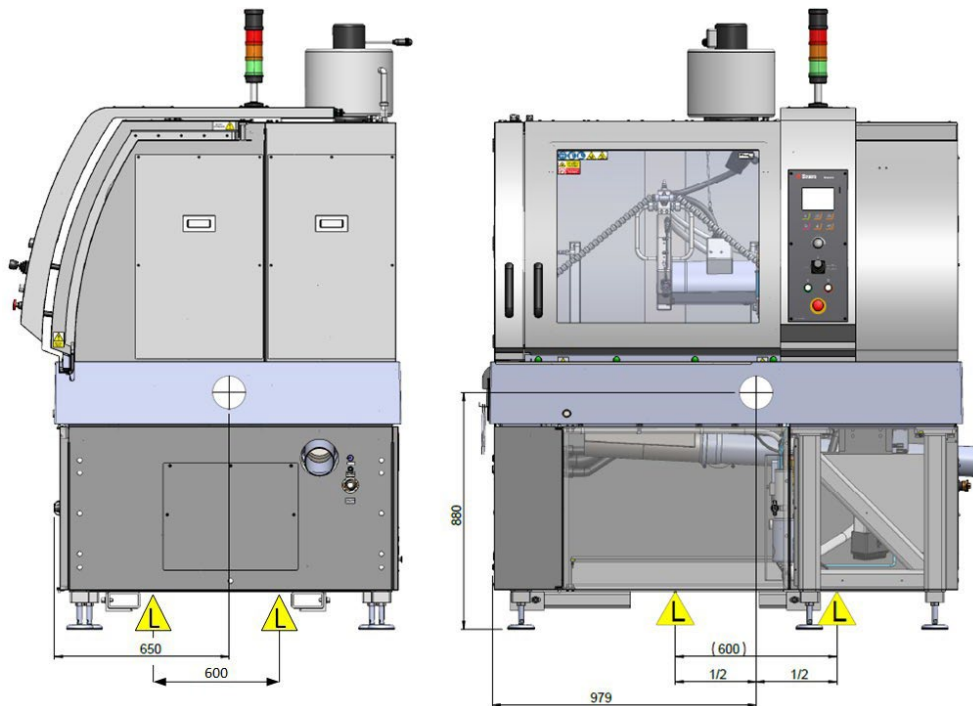

Magnutom is mounted with removable lifting beams.



NOTE:

Ensure, that the lifting beams are securely mounted before lifting the machine.

NOTE:

Remove the lifting beams when the machine is in its final destination. It is not necessary to remove the transport beams.

When using a forklift truck, these instructions **MUST** be followed:

- To lift the machine from the front, place the forks as indicated above. This method is recommended.
- To lift the machine from the right side, place the fork as indicated above (most of the weight is at this end).
Remember, that the forks must support the machine in its entire length. The forks must be at least 2 meters / 6' 7" long
- If lifting from the left side is necessary, it should be performed with *extreme care* as most of the weight is at the right side of the machine.
- Remember, that the forks must support the machine in its entire length. The forks must be at least 2 meters / 6' 7" long.
- Ensure that the lifting straps are placed at the lifting points.

Crane



CRUSHING HAZARD

Straps and crane must be certified to lift at least twice the weight of the machine.

When Magnutom is in its final position:

- Adjust the 6 legs to level the Magnutom. Place the level device on the cutting table.



CAUTION

Failure to level the machine before putting it into operation will damage the machine.



NOTE:

Joystick is overlapping machine, be careful during manipulation.

Power supply

The machine is delivered without a mains cable. A 4-lead or 5-lead cable is required.

The cable is connected to the electric connection box at the rear of the machine.

Connections

Yellow/green	Earth (ground)
Brown or Black, Black or Red, Grey or Orange	Line (live) L1, L2, L3
Blue or White	Neutral (terminal is only used for a mechanical connection)

Mains cable specification

Wires	4-lead: 3 phases + PEN 5-lead: 3 phases + PE + N
Wire gauge (Copper only)	EU: Min. 10 mm ² North America: Min. AWG8
Isolation	Electrical strength of isolation of each wire in cable: min. 600V
Cable diameter	Max. 28 mm

Please refer to the Instruction Manual → Technical Data for Electrical data.

The other end of the cable can be fitted with an approved plug or hard-wired into the mains, according to the electrical specifications and local regulations.



NOTE:

Local standards may overrule the recommendations for the main supply cable. If necessary, please contact a qualified electrician to verify which option is suitable for the local installation setup.

Residual Current Circuit Breaker (RCCB) Electrical Installations with RCCB

The equipment must be protected by RCCB type B time delayed, 30 mA (or better).

Electrical Installations without RCCB

The equipment must be protected by an insulation transformer (double-wound transformer).



NOTE:

Please contact a qualified electrician to verify which option is suitable for the installation setup.

External Short Circuit Protection

Magnutom must be protected with external fuses.

Recommended fuse size: 63A.

Max allowable fuse: 80A.

Safety specifications

Stop Mechanisms

Safety Circuit	Designed to comply with a minimum of:
Guard interlock	EN ISO 16089:2015, Performance level D
Guard interlock lock, chamber access	EN ISO 13849-1, Performance level C
Guard interlock lock, afterrun after STOP	EN ISO 13849-1, Performance level A
Guard interlock lock, afterrun after power fail	EN ISO 13849-1, Performance level A
Axis hold-to-run with speed monitoring	EN ISO 16089:2015, Performance level C
Axis speed monitoring with hold-to-run	EN ISO 16089:2015, Performance level D
Emergency stop	EN ISO 13850:2015 und EN ISO 16089:2015, Performance level C
Unexpected fluid supply start	EN ISO 16089:2015, Performance level B

Cutting liquid	<input checked="" type="checkbox"/> Required	<input type="checkbox"/> Option
-----------------------	---	--

A Recirculation Cooling Unit is required. See Accessories on page 141 for details.

Water outlet	<input checked="" type="checkbox"/> Required	<input type="checkbox"/> Option
---------------------	---	--

The machine is supplied with a set of drain pipes. The pipes are fitted to redirect the cooling water into the recirculation cooling unit.

Compressed air	<input checked="" type="checkbox"/> Required	<input type="checkbox"/> Option
-----------------------	---	--

Tube Connection	8 mm dia. (push-in connection)
Connection	To be fitted with local standard connections
Pressure	5,5–9,9 bar/80–145 psi, min 40 l/min
Recommended quality	Class-3, as specified in ISO 8573-1.

Exhaust	<input type="checkbox"/> Required	<input checked="" type="checkbox"/> Option
----------------	--	---

Recommended:
Capacity: 700m³/h / 25,000 ft³/h at 0 mm /0" water gauge.
Exhaust connection (diameter): 160 mm (6.3")

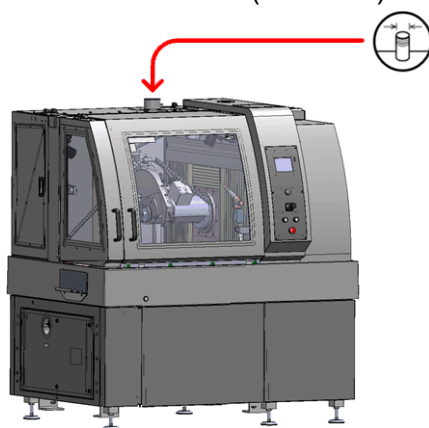

Ambient conditions



5–40 °C/40–104 °F (operative)
0–60 °C/32–140 °F (storage)



10–85 % RF (operative)
0–90 % RF (storage)

Accessories and consumables

Recirculation Cooling Unit

Please refer to the [Magnutom Brochure](#) and the [Struers Cut-off Wheels brochure](#) for details of the range available.

Required

Struers Coolimat-2000 with band filter unit (065261xx) or Coolimat-2000 static filter (065262xx) are recommended. They are supplied with a 2.5 m / 8.2' water hose and a GEKA connection for easy assembly.

A compact cooling system can be used in cases where space is restricted and a lower capacity (minimum 150 l) is acceptable in terms of performed sections per day.

Minimum requirements:

Pump capacity with minimum output 50 l/ hr, max. water output pressure 4,9 bar.

Required

Additive for recirculation cooling unit, to prevent corrosion and improve cutting results.

Struers *Corrozip* is recommended.

The use of Struers consumables is recommended.

Other products (e.g. coolants) may contain aggressive solvents, which dissolve e.g. rubber seals. The warranty may not cover damaged machine

parts (e.g. seals and tubes), where the damage can be directly related to the use of non-Struers consumables.

Declaration of Conformity

Manufacturer	Struers ApS • Pederstrupvej 84 • DK-2750 Ballerup • Denmark
Name	Magnutom-5000
Model	N/A
Function	Cut-off machine
Type	658
Cat. no.	Magnutom-5000 06586146 06586246 06586346 Accessories equipment 06146914 06146912
Serial no.	



Module H, according to global approach

EU

We declare that the product mentioned is in conformity with the following legislation, directives and standards:

2006/42/EC	EN ISO 12100:2010, EN ISO 13849-1:2015, EN ISO 13849-2:2012, EN ISO 13850:2015, EN ISO 16089:2015, EN 60204-1:2018, EN 60204-1-2018/Corr.:2020
2011/65/EU	EN 63000:2018
2014/30/EU	EN 61000-3-11:2001, EN 61000-3-12:2012, EN 61000-6-2:2005, EN 61000-6-2:2005/Corr.:2005, EN 61000-6-3:2007, EN 61000-6-3:2007/A1:2011, EN 61000-6-3-A1-AC:2012
Additional standards	NFPA 79, FCC 47 CFR Part 15 Subpart B

Authorized to compile technical file/
Authorized signatory

Date: [Release date]



Pederstrupvej 84
DK-2750 Ballerup
Denmark