

Duramin-160

Instruction Manual



Duramin-160
Instruction Manual

Table of Contents	Page
Intended use	4
Safety Precaution Sheet.....	5
Icons and typography	7
User's Guide.....	9
Contents of the Declaration of Conformity	39

Intended use

Automatic Macro hardness tester for Rockwell hardness testing of materials.

The hardness tester meets the applicable DIN, ISO-EN, ASTM and JIS standards.

Before using this machine, read this user manual carefully to use the product properly. After reading, keep the manual in an easy-to-access place for referencing whenever needed.

The machine is for use in a professional working environment (e.g. production floor or materialography laboratory).

The machine should only be used for its intended purpose and as detailed in the Instruction Manual.

Models:

Duramin-160
Duramin-160 Z

Always state *Serial No* and *Voltage/frequency* if you have technical questions or when ordering spare parts. You will find the *Serial No.* and *Voltage* on the type plate of the machine itself. We may also need the *Date* and *Article No* of the manual. This information is found on the front cover.

The following restrictions should be observed, as violation of the restrictions may cause cancellation of Struers legal obligations:

Instruction Manuals: Struers Instruction Manual may only be used in connection with Struers equipment covered by the Instruction Manual.

Service Manuals: Struers Service Manual may only be used by a trained technician authorised by Struers. The Service Manual may only be used in connection with Struers equipment covered by the Service Manual.

Struers assumes no responsibility for errors in the manual text/illustrations. The information in this manual is subject to change without notice. The manual may mention accessories or parts not included in the present version of the equipment.

Original instructions. The contents of this manual are the property of Struers. Reproduction of any part of this manual without the written permission of Struers is not allowed.

All rights reserved. © Struers 2023.

Struers
Pederstrupvej 84
DK-2750 Ballerup
Denmark
Telephone +45 44 600 800
Fax +45 44 600 801



Duramin-160 Safety Precaution Sheet

To be read carefully before use

1. The operator(s) must read the Safety and User's Guide sections of this manual and the relevant sections of the manuals for any connected equipment and accessories.

⚠ WARNING!

Ignoring this information and mishandling of the equipment can lead to severe bodily injuries and material damage.

1. The machine must be installed in compliance with local safety regulations.
2. The machine must be placed on a safe and stable support. Failure to do so can affect the proper working and cause the equipment to fall down and/or cause accidents and injuries. All safety functions and guards of the machine must be in working order.
3. Do not modify this equipment. Doing so can cause fire and/or electric shock.
4. Do not twist or damage the power cords. Damaged power cords can cause fire and/or electric shock.
5. Do not disassemble this equipment. Doing so can cause electric shock.
6. Do not operate the equipment at a voltage other than the power voltage that is indicated. Doing so can cause fires.
7. Do not allow the machine to become wet. Fires can occur if water gets inside the equipment.
If water or other liquid does get inside the equipment, turn off the power to the equipment's main unit, disconnect the power supply, and call technical service.
8. If malfunctions, smoke or unusual noises are observed - turn off the power, disconnect the power supply and call technical service.
9. Do not connect/ disconnect power with wet hands. Doing so can result in electric shock.

Duramin-160
Instruction Manual

- 10.** Disconnect the power supply prior to any cleaning, maintenance or service.
Failure to do so can result in electric shock.
- 11.** Do not block the ventilation. Blocking the ventilation can cause heat to accumulate inside the machine, which in turn, can generate fire.
- 12.** Do not open any panel on the machine.
High voltages exist inside the machine and may cause electrical shocks to personnel.

The equipment should only be used for its intended purpose and as detailed in the Instruction Manual.

The equipment is designed for use with consumables supplied by Struers. If subjected to misuse, improper installation, alteration, neglect, accident or improper repair, Struers will accept no responsibility for damage(s) to the user or the equipment.

Dismantling of any part of the equipment, during maintenance, service or repair, should always be performed by a qualified technician (electromechanical, electronic, mechanical, pneumatic, etc.)

Icons and typography

The following icons and typographic conventions are used in this instruction manual:

Icons and Safety Messages



ELECTRICAL HAZARD

indicates an electrical hazard which, if not avoided, will result in death or serious injury.



DANGER

indicates a hazard with a high level of risk which, if not avoided, will result in death or serious injury.



WARNING

indicates a hazard with a medium level of risk which, if not avoided, could result in death or serious injury.



CAUTION

indicates a hazard with a low level of risk which, if not avoided, could result in minor or moderate injury.



CRUSHING HAZARD

indicates a crushing hazard which, if not avoided, could result in minor, moderate or serious injury.

General Messages



Important or Note

indicates a risk of damage to property, or the need to proceed with special care.



Information or Tip

indicates additional information and tips.

Colour Inside Logo



The 'colour inside' logo on the cover page of this Instruction Manual indicates that it contains colours which are considered to be useful for the correct understanding of its contents.

Users should therefore print this document using a colour printer.

Typographic conventions

Bold type	indicates button labels or menu options in software programs
<i>Italic type</i>	indicates product names, items in software programs or figure titles
■ Bullets	indicates a necessary work step

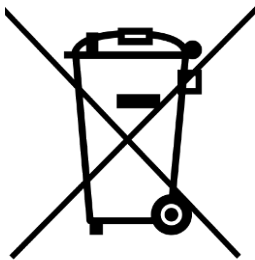

Disposal

Equipment marked with a WEEE symbol  contain electrical and electronic components and must not be disposed of as general waste.

Please contact your local authorities for information on the correct method of disposal in accordance with national legislation.

User's Guide

Table of Contents	Page
1. Getting Started	
Unpacking Duramin-160.....	11
Location.....	12
Lifting Duramin.....	13
Placing Duramin-160.....	14
Levelling	14
Removing the Lifting Bar	14
Checking the Contents.....	15
Getting Acquainted with Duramin-160	16
USB Drive and WiFi Adapter	17
Rear plate.....	17
Noise Level.....	17
Power Supply	18
Connecting the Tester.....	18
Installing an indenter.....	19
Installing an anvil.....	19
Nose cone adjustment.....	19
Installing a table.....	20
2. Basic Operations	
Front Panel Controls.....	21
Hold-to-run button.....	21
Software.....	22
Start-up.....	22
Overview Screen	24
Main menu.....	25
Test result and settings	25
Test settings.....	25
Dashboard Controls	25
Performing a Rockwell test.....	26
3. Maintenance	
General Cleaning.....	30
Daily Maintenance	30
Weekly Maintenance.....	30
Cleaning Surfaces.....	30
Weekly Inspection.....	30
Yearly Maintenance.....	30
Replacing the Fuse	31
Calibration	31

4. Struers Knowledge.....	32
5. Trouble shooting	33
6. Transport.....	34
7. Technical Data.....	35

1. Getting Started

Unpacking Duramin-160



Important

Refer to the **HOW TO UNPACK** instructions delivered with Duramin.

Take care whilst unpacking and handling Duramin.

Do not expose to external impact.

Do not tilt over 30 degrees.

Do not touch the turret.

- Carefully open and remove the top of the packing crate.
- Remove the sides of the packing crate.
- Remove the accessories case(s).
- Carefully lift the foam pieces to access Duramin.



Store the packing crate and foam packaging for use whenever Duramin is transported/re-located.

Failure to use the original packaging and fittings could cause severe damage to the tester and will void the warranty.

- Remove the plastic covering.

Location

- Duramin must be placed close to the power supply.
- Duramin is designed to be placed on a rigid, stable workbench with a horizontal surface.
The workbench must be able to carry at least 170 Kg / 370 lbs.

Minimum workbench dimensions:

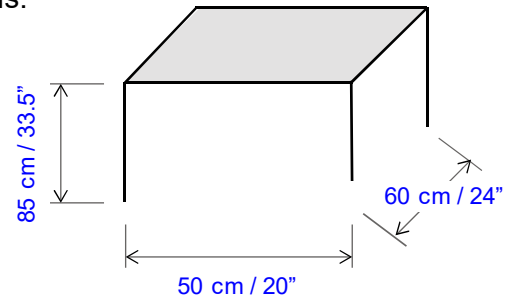

To take advantage of the maximum spindle capacity, a hole must be drilled in the table top to accommodate the full stroke of the spindle. Please refer to the *Drilling Plan* for dimensions.

Vibration-free Location

- Install Duramin in a vibration-free location.



Important

Vibrations can lead to inaccurate measurements and must be avoided.

A simple way of detecting vibrations is to set up a tray of water and watch for ripples on the surface.

Sources of vibration can include:

- Passers-by (persons walking past), a road with heavy traffic, cranes, equipment generating vibrations, equipment generating sound (acoustic vibration), exposure to wind or air conditioning fans.

If possible, install the hardness tester on the ground floor of a building and away from exits or doorways.

Lifting Duramin

A crane and lifting straps are required to lift the machine from the packing crate.



Important

Take care whilst handling Duramin.
Do not expose to external impact.
Do not tilt over 30 degrees.
Do not touch the turret.

- Check that the crane has a free pathway from the lifting point to the final location.
- Place the lifting straps securely around the lifting bar.
- Remove the bolts securing Duramin to the pallet.
- Carefully lift Duramin out of the packing crate.
- Install the 4 adjustable vibration dampers and adjust the height of the dampers until they are of equal height.
- Lift Duramin into its final location

Placing Duramin-160 Levelling

To eliminate possible wear and tear or the testers mechanical structure, the tester should be levelled once it is in its final location.

- Check that the anvil is level.



If not:

- Turn the vibration damper in the rear right hand corner to level the anvil.



Removing the Lifting Bar

- Support the lifting bar and remove the screws and washers from both sides of the bar.



Important
Keep the lifting bar, screws and washers for use whenever the machine is to be relocated.

Duramin-160
Instruction Manual

Checking the Contents

In the packing crate you should find the following parts:

- 1 Duramin-160 (Hardness Tester)
- 1 Accessories Case

Accessories Case
Standard Accessories



- Indenter(s)
 - 1 Flat anvil, hardened, 60mm dia.
 - 2 Fuse 3A slow
 - 2 Power cables
- 4 Vibration dampers (feet)
- 1 Certificate of calibration
- 1 Instruction Manual set

Optional Accessories

- Please consult your order confirmation to check that all the accessories ordered are included in the delivery.



Information
Some components or parts may be packaged separately and may not be included in the accessory case or may have been installed on the hardness tester.



Information
The actual packaging and accessories may appear different to those shown in the picture.

Getting Acquainted with Duramin-160

Take a moment to familiarise yourself with the location and names of the Duramin-160 components.

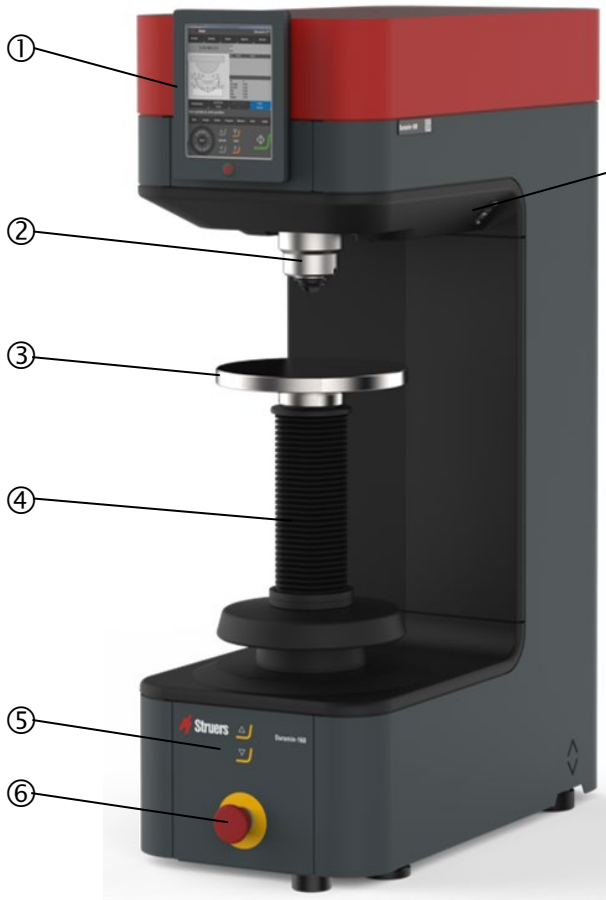

- ① Display
- ② Nose cone
- ③ XY-stage
- ④ Spindle cover
- ⑤ Z-axis control (Option)
- ⑥ Emergency stop
- ⑦ USB port

Hold-to-run button (not visible)

Power Connections

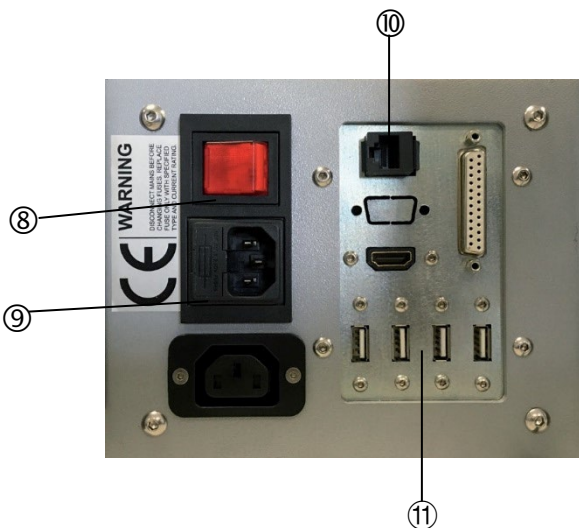

- ⑧ Main power switch
- ⑨ Main power connection
- ⑩ Network (RJ-45 LAN connection)
- ⑪ USB connections

USB Drive and WiFi Adapter



The USB drive contains direct and indirect calibration documents.



The USB WiFi Adapter allows for cable free communication with the Duramin.

Rear plate

Information on the model number, serial number, weight, date of manufacture, and power requirements can be found on the type plate on the back of the machine.

Noise Level

Less than 70¹ dB(A) measured at idle running, at a distance of 1.0 m/39.4" from the machine.
Use hearing protection if exposure to noise exceeds levels set by local regulations.

¹ "The figures quoted are emission levels and are not necessarily safe working levels. Whilst there is a correlation between the emission and exposure levels, this cannot be used reliably to determine whether or not further precautions are required. Factors that influence the actual level of exposure of the workforce include the characteristics of the workroom and the other sources of noise, i.e. the number of machines and other adjacent processes and the length of time for which an operator is exposed to the noise. Also, the permissible exposure level can vary from country to country. This information, however, will enable the user of the machine to make a better evaluation of the hazard and risk."
(ref. EN ISO 16089:2015)

Power Supply

Connecting the Tester

Always remember to switch the power off when installing electrical equipment!



ELECTRICAL HAZARD

- The machine must be earthed.
- Check that the mains voltage corresponds to the voltage stated on the type plate on the side of the machine. Incorrect voltage may result in damage to the electrical circuit.

Duramin-160 is shipped with 2 types of Mains cables:

Single-phase Supply



The 2-pin (European Schuko) plug is for use on single-phase connections.

If the plug supplied on this cable is not approved in your country, then the plug must be replaced with an approved plug. The leads must be connected as follows:

Yellow/green: earth (ground)

Brown: line (live)

Blue: neutral

3-phase Supply



The 3-pin (North American NEMA) plug is for use on 3-phase power connections.

If the plug supplied on this cable is not approved in your country, then the plug must be replaced with an approved plug. The leads must be connected as follows:

Green: earth (ground)

Black: line (live)

White: line (live)

Connection to the Machine

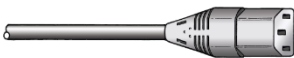

- Connect the power cable to the machine. (IEC 320 connector).
- Connect to the mains power supply.

Installing an indenter



Duramin-160 is delivered with pre-installed indenter as ordered.

Important

Do not use other than Struers accessories

To install additional indenters:

- Use a soft cloth to wipe any dirt or debris from the indenter, indenter holder or shaft.
- Insert the shank into the indenter holder and push firmly into place.
- Install an anvil and run a test on a test block to securely seat the indenter.

Installing an anvil

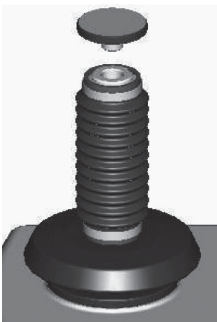

Important

Do not use other than Struers accessories

Use the appropriate anvil for the application:

- V type anvil for cylindrical samples (Option)
- Flat anvil for flat samples

To install an anvil:

- Check there is enough room between the indenter and the spindle to install the anvil.
- Use a soft cloth to wipe any dirt or debris from the mat surfaces of the anvil and spindle.
- Carefully place the anvil into the spindle.
- Perform a few hardness tests on a test block to securely seat the anvil.

Nose cone adjustment

The nose cone should rest on the sample. If necessary, turn the nose cone until it sits lightly on the sample.

Installing a table



Important

Do not use other than Struers accessories

Use the appropriate table for the application:

To install a table:

- Check there is enough room between the indenter and the spindle to install the table.
- Use a soft cloth to wipe any dirt or debris from the mat surfaces of the table and spindle.
- Carefully place the table into the spindle.
- Perform a few hardness tests on a test block to securely seat the table.

2. Basic Operations

Front Panel Controls

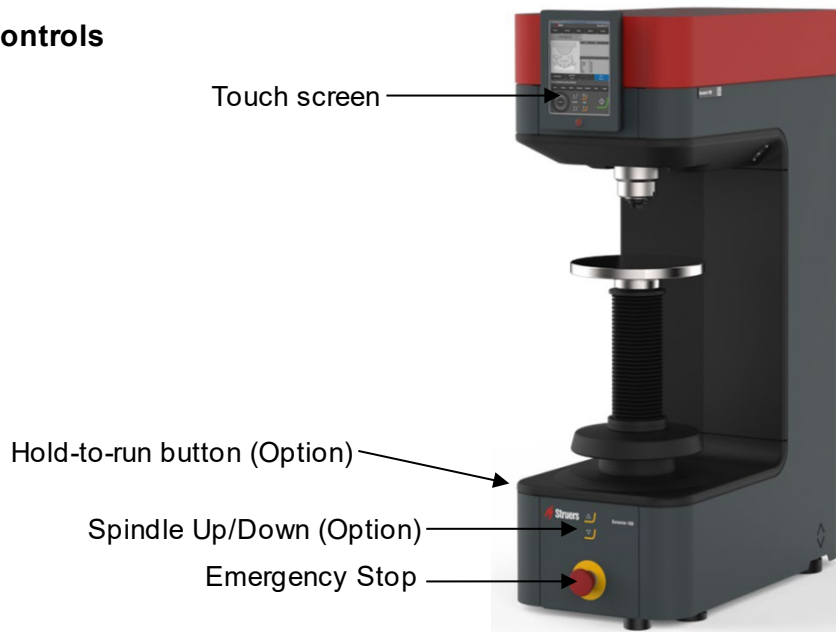

MAIN SWITCH

The main switch is located on the rear of the machine.
The main switch will be illuminated when power is connected.



The EMERGENCY STOP is located on the front of the machine.
Emergency Stop

- Push the red button to Activate.
- Turn the red button clockwise to Release.



Important
Do not use the Emergency stop for operational stop of the machine during normal operation.
BEFORE releasing (disengaging) the Emergency stop, investigate the reason for activating the Emergency stop and take any necessary corrective action.

Hold-to-run button

When moving the spindle using the Up/Down keys, the Hold-to-run button must be pressed continuously.

Software

Duramin-160 is operated through the Duramin software. A short description of the software is included in this manual. Please refer to the Duramin software manual for a detailed description of the software functions.

Start-up

- Switch Duramin-160 on using the main switch at the rear. The Duramin software will initialize and the following progress bar will appear on the display:

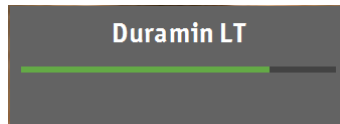

Note: Duramin-160 will beep during initialization.



Tip

Make sure that the emergency stop is not activated during start-up.

If the emergency stop is activated during start-up, a failure message will appear.

- Release the emergency stop.
- Touch the screen to acknowledge the pop-up message.
- Re-start the Duramin software by double clicking on the Duramin icon on the display.

The following screen will appear on the display.

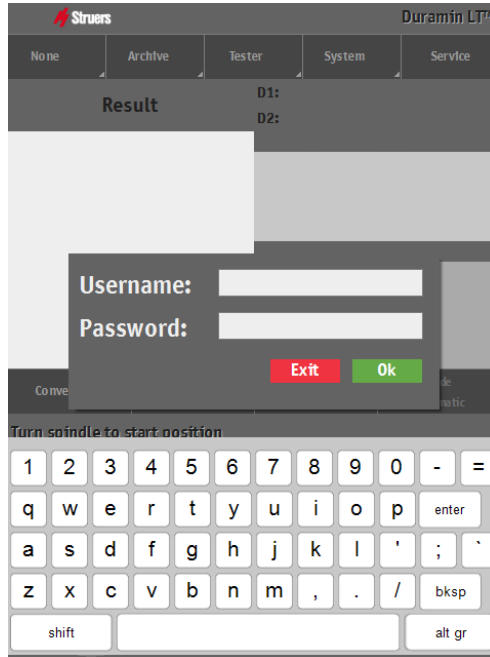

Information

The actual screen may appear different depending on the configuration and model of the Duramin-160.

- Push gently in the middle of the designated buttons for tester operation. Do not use force. Do not use sharp objects.
- Enter the *Username* and *Password*.
When Duramin is used for the first time, the default will be:
Username: Admin
Password: none
- Press **Ok**.



Tip

The default username is not case sensitive.

For instructions on how to add new users, please refer to the Software manual.

Overview Screen

The overview screen is primarily divided into 4 main areas.

- Main menu
- Test result
- Test settings
- Dashboard Controls

The screenshot shows the Duramin LT™ software interface. At the top, there is a main menu with options: Rockwell, Archive, Tester, System, and Service. Below this, the current test result is displayed as 0.00 HRC. To the right, sensor displacement is 0.000 mm and Rockwell Depth is 0.0 µm. A table shows test results for three specimens:

Nr	Value	Sc...
18	34.29	HRC
19	62.47	HRC
20	62.50	HRC
21	42.06	HRC

Below the table, a diagram illustrates the Rockwell testing process on a test specimen, showing stages A (Pre load applied), B (Main load applied), and C (Main load removed). It also labels 'Permanent depth of indentation' and 'Elastic recovery'. To the right of the diagram, a summary table provides statistical data:

Nr	21
Average	36.66
Std.dev	14.50
Mfn	6.01
Max	62.65
Range	56.64

At the bottom, there are test settings (Conversions, Dwell time: 3 Sec, Shape correction: Off, Mode: Automatic) and a row of function buttons (Save, Escape, Delete, Program, Print, Limits). The dashboard controls at the very bottom include a 'ROCKWELL Diamond' logo and a diamond-shaped icon with a vertical line.

Duramin-160 Instruction Manual

Main menu

The *Main Menu* is used to select the test method and scale required as well as adjusting settings and other functions.

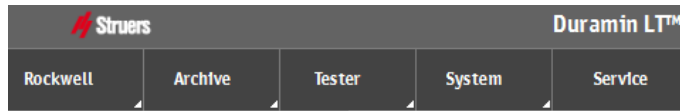

Test result and settings

The *Test Result and settings* shows an image of the indent (or the indent pattern) and a list of the indents performed.

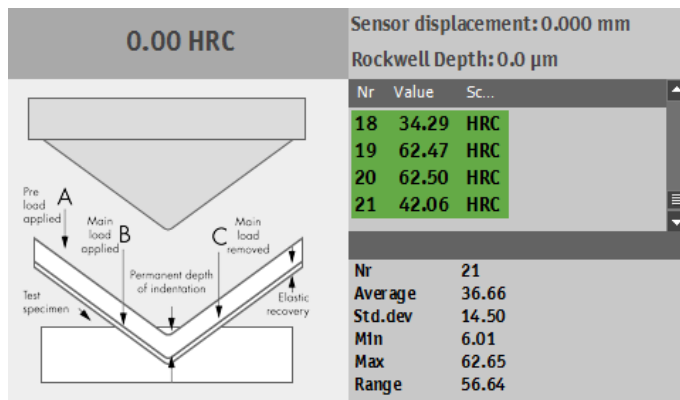

Test settings

The *Test Settings* menus are used to select test patterns and to perform additional functions.

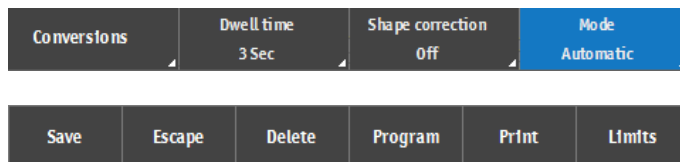

Dashboard Controls

The *Dashboard Controls* are used to view the indenter selected and to start the indentation process.



Please refer to the *Duramin Software manual* for a detailed description of the software and its functions.

Performing a Rockwell test

Checking the Sample

- Check that the sample surface is smooth and even.
- Check that the sample surface is free from oxide scale, foreign matter and, in particular, completely free from lubricants.

Scale selection

- Setup the tester with the required Rockwell scale and indenter.

Placing the Sample

- Place the sample on the Anvil.

Positioning

- Turn the elevator spindle clockwise until the sample firmly touches the clamping attachment.
The indenter should be no more than 1mm from the sample.



Note

If too much manual force is applied while performing a Rockwell test, the user interface will give a clear warning.

Starting the test



- Press **Start** to start the test.
The testing procedure will proceed automatically.



- The start button will turn into a red stop button.
 - Press **Stop** to interrupt the test.
(Do not use the Emergency Stop unless necessary).

Applying Preload

The indenter will automatically move downwards until it reaches the pre-load position.
The tester will now first apply the pre-load (3kgf for Superficial scales and 10kgf for regular Rockwell scales).

This process is represented visually on the display.

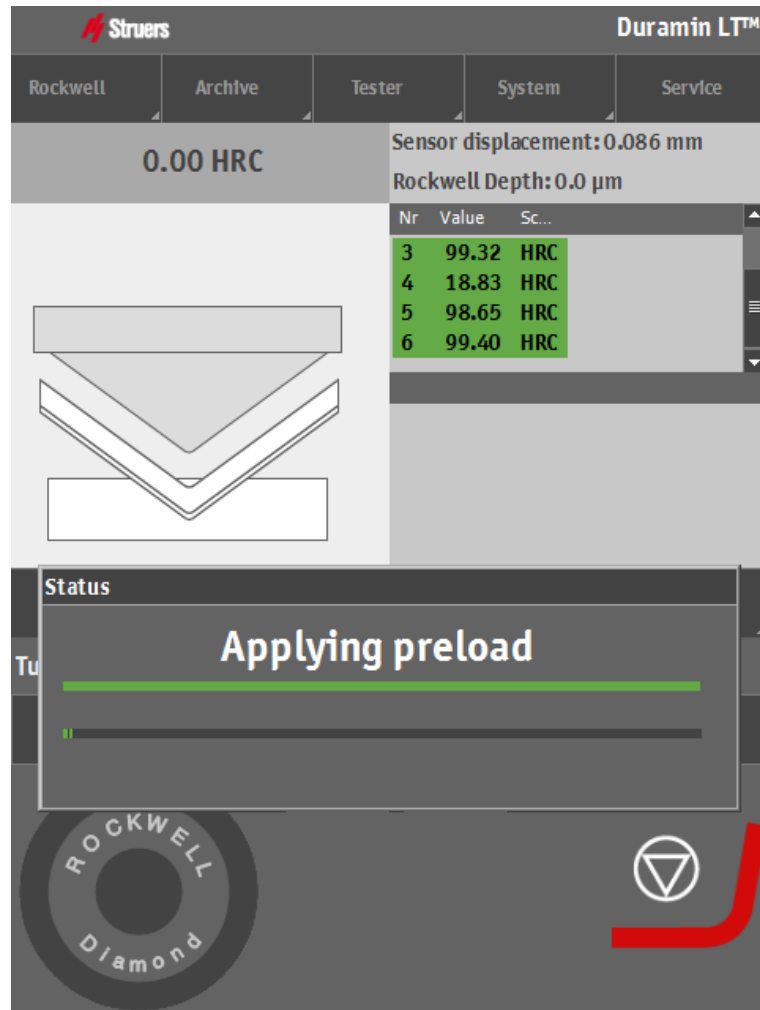

Applying Main load

After the pre-load has been applied the tester will automatically apply the main load.

After the main load has been applied the tester will pause for the selected dwell time. When the dwell time has passed, the tester will automatically release the main load and return to the pre-load position.

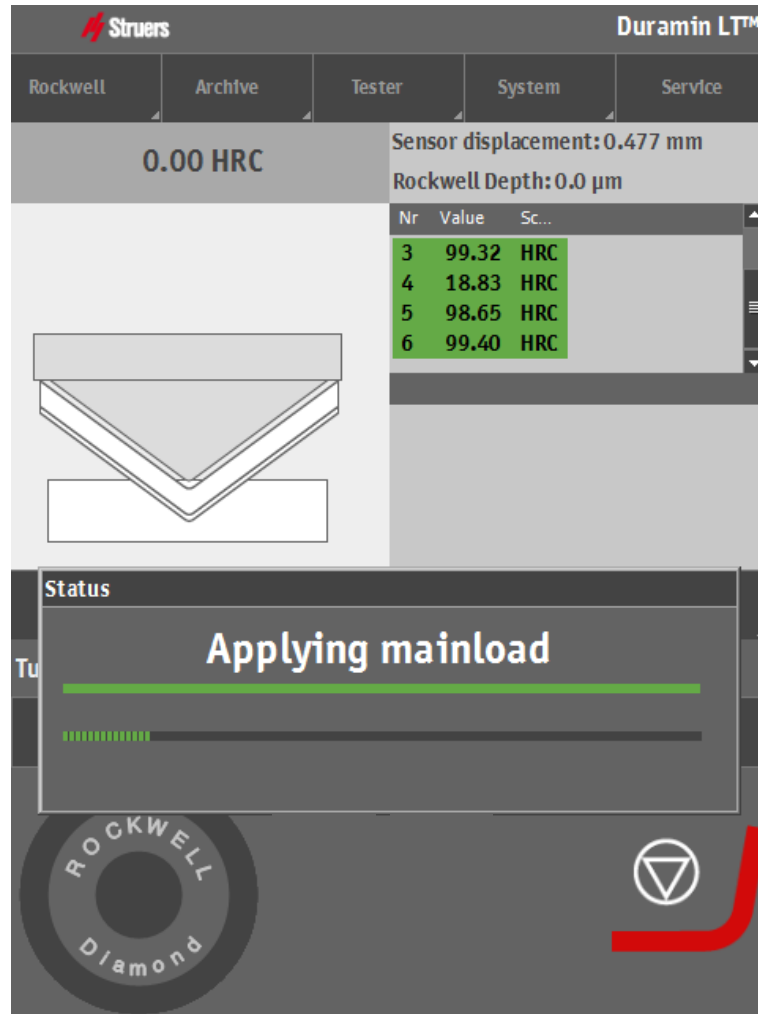

The hardness value measured will be displayed.

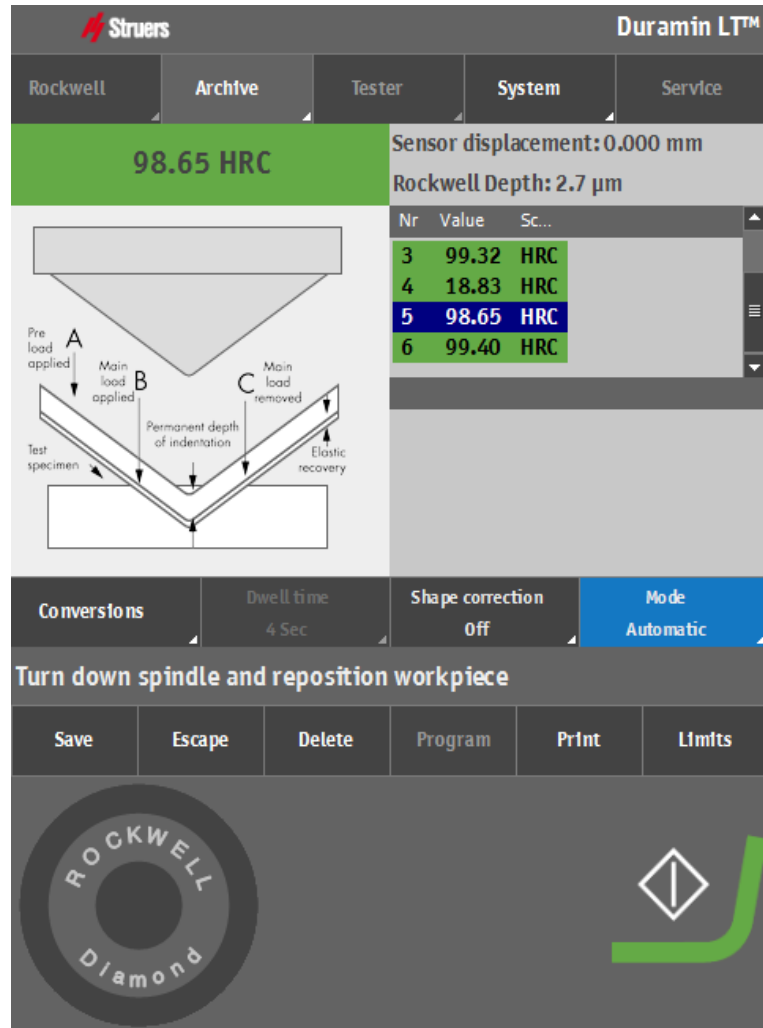

- Turn the elevator spindle counter clockwise and move the Sample into a new position to perform another test.
 - If a clamping attachment is used, release the clamps before moving the sample to its new position.



Information
The first Rockwell reading on the sample should not be considered in the statistics.

3. Maintenance

General Cleaning

- Keep Duramin-160 as clean as possible.
To ensure a longer lifetime for your equipment Struers strongly recommends regular cleaning.

Daily Maintenance Machine

- Clean all accessible surfaces with a soft, damp cloth.



Tip

Do not use a dry cloth as the surfaces are not scratch resistant.
Do not use aggressive or abrasive products.
Grease and oil can be removed with ethanol or isopropanol.



Important

Never use acetone, benzol or similar solvents.

Weekly Maintenance Cleaning Surfaces

- Clean painted surfaces and the control panel with a soft damp cloth and common household detergents.

Weekly Inspection

- Inspect the following parts before every hardness test or at least weekly.

Part	Attention	Action	Precaution
Indenter	Tip dirty	Wipe indenter	Do not bend the indenter shaft
Anvil	Rust	Remove rust	Do not bring the stage into contact with the turret.
Test block	Rusted	Replace test block	Do not use rusted test blocks

Yearly Maintenance

- Clean the elevator spindle and oil lightly with e.g. a universal household oil (do NOT lubricate the spindle with motor oil).
 - Carefully lift the spindle cover.
 - Wipe the spindle THOROUGHLY after lubrication so that as little as possible oil is left on the spindle.
 - Wipe the spindle again after a few days to ensure no oil residue is left on the spindle surface.

Replacing the Fuse

The fuse holder is located directly under the power connection on the rear of Duramin-160.

- Turn Duramin-160 off.
- Disconnect the power cable.
- Pull out the fuse holder using a flat-head screwdriver.

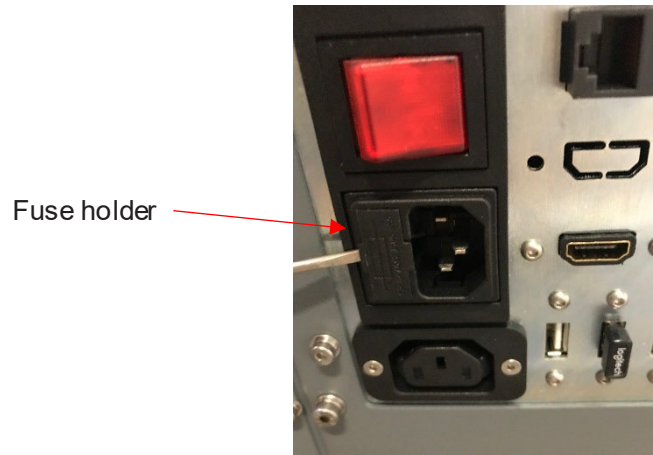

- Take out the blown fuse and replace with the reserve fuse.

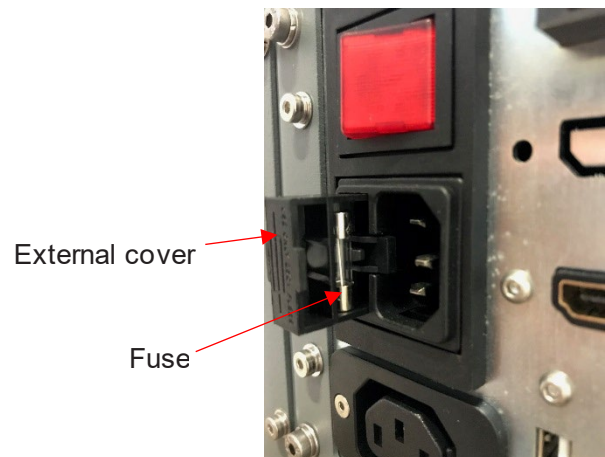

- Re-install the fuse holder.
- Re-connect the electric power cable.



Tip
Remember to order a new reserve.

Calibration

Duramin-160's highly sensitive and accurate load cell and objectives are calibrated prior to shipping.

Please contact Struers Service should the load cell or objectives require recalibration.

4. Struers Knowledge

The need for fast, robust and well proven test methods for materials verification is inevitable. Vickers, Knoop, Rockwell and Brinell methods, with a countless number of loads and indenter geometries, gives an almost countless number of procedures, suitable for simple characterization of a large fraction of existing materials.



Visit the Struers Hardness testing website for a comprehensive introduction to the principles of hardness testing, useful troubleshooting tips and the latest application knowledge in the field.

Click on the link: [Struers - Ensuring Certainty / Knowledge / Hardness testing](#)

OR

Scan the QR code on the Duramin tag on your machine



5. Trouble shooting

Some of the minor malfunctions can be resolved by restarting the tester:

- Press **System**, then **Exit**.
- Click on the stop icon on the taskbar to shut down the embedded PC.

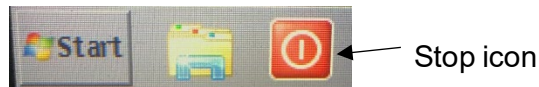

- Switch Duramin Off, then switch on again to start initialization.

Error	Explanation	Action
Start-up failure	The emergency stop is activated	- Release the emergency stop. - Restart the tester.
Max down reached!	The maximum down position of the force actuator has been reached.	
Motor failure!	Failure of force application motor.	- Restart the tester. If the error remains, contact Struers Service.
System not initialized!	Failure of Software communication.	- Restart the tester. If the error remains, contact Struers Service.
Failed to open connection to AUX on EURP AUX Virtual Com Port (COM3)	Failure of Software communication.	- Restart the tester. - Press System , then Exit . - Switch Duramin Off, then switch on again to start initialization. If the error remains, contact Struers Service.
Load motor is not in home position		- Press Escape . - Then press Start . If this does not help, - Restart the tester. If the error remains, contact Struers Service.

6. Transport

The hardness testing machine must always be transported standing upright!

DO NOT ship or transport the tester without the correct packing materials.



**Store the packing crate, foam packaging and fittings for use whenever Duramin is transported/re-located.
Failure to use the original packaging and fittings could cause severe damage to the tester and will void the warranty.**

DO NOT ship or transport the tester without mounting lifting bar
This could cause severe damage to the testers load application system.

7. Technical Data

Please refer to the [Duramin Product Overview brochure](#) for further details.

		Duramin-160
Hardness methods	Vickers	NA
	Knopp	NA
	Brinell	Optional
	Rockwell - optional	ISO 6508 ASTM E18 JIS Z 2245
Force range		9.8 - 2451 N (1 - 250 kgf)
Test force	Force application	Fully automatic, closed loop, force feedback, loading, dwell, unloading
	Test force tolerance	0.5 %
	Dwell time settings	Adjustable 1 to 99 s
Turret		1
Electrical data	Power supply	100 V AC - 240 V AC, 50 / 60 Hz, single phase
	Power consumption load	29 W
	Power consumption idle	23 W
	Power consumption max. load	30 W
Dimensions	Width	291 mm (11.5")
	Depth	580 mm (22.8")
	Height	855 mm (33.7")
Weight	Duramin-160	146 kg (322 lbs)
	Duramin-160 Z	156 kg (344 lbs)
Read method		Automated
Overview camera resolution		NA
Overview camera field of view		NA
Measurement camera resolution		NA
Positions in nosepiece		1
Max no. of indenters		1
Max no. of objectives		NA
Indenter Shaft	Diameter	6.35 mm
Standard objectives included		NA

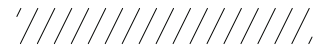
TECHNICAL DATA
Duramin-160

Duramin-160		
Z-Axis		Manual (Motorized optional)
Anti-collision protection		No
XY Stage / Anvil		Anvil
Stage Size		Ø 80 mm (3.1")
Stage Stroke (travel range)		NA
Auto Illumination		No
Stage Illumination		Yes
Laser/LED Guide		No
Software	Operating software	Windows 10
	Integrated PC	Embedded Windows PC
	Monitor	6.5" portrait mode capacitive touch screen
	Dual view	No
	Possibility to connect printer	No
	Ethernet Connection	No
	Data Export	UTP network, USB A 3.0, USB A 2.0, Bluetooth
System	Data output	CSV, PDF
Software modules		Total test, max, min, average, range, standard deviation, all in real time after each test
Sample height		315 mm (12.4")
Throat depth		195 mm (7.7")
Safety standards		CE labelled according to EU directives
REACH		For information about REACH. contact your local Struers office
Operating environment	Surrounding temperature	10 - 35°C (50 - 95°F)
	Humidity	10% - 90% RH non-condensing
Safety Circuit Categories/Performance Level	Emergency stop	EN ISO 13849-1 PL c, Category 1
		Stop category 0
Noise level	A-weighted sound emission pressure level at workstations	< 70 dB(A)
Vibration level	During operation	Total vibration exposure to upper parts of the body does not exceed 2.5 m/s ² .

Declaration of Conformity

Manufacturer	Struers ApS • Pederstrupvej 84 • DK-2750 Ballerup • Denmark
Name	Duramin-160
Model	N/A
Function	Hardness tester
Type	662
Cat. no.	06626101, 06626111, 06626311
Serial no.	



Module H, according to global approach



We declare that the product mentioned is in conformity with the following legislation, directives and standards:

2006/42/EC	EN ISO 12100:2010, EN ISO 13850:2015, EN ISO 13849-1:2015, EN ISO 13849-2:2012, EN 60204-1:2018
2011/65/EU	EN 63000:2018
2014/30/EU	EN 61000-3-2:2014, EN 61000-3-3:2013, EN 55011:2016/A1:2017/A11:2020, EN 61326-1:2021

Authorized to compile technical file/
Authorized signatory

Date: [Release date]



Pederstrupvej 84
DK-2750 Ballerup
Denmark